

# 935AT Communications Test Set



## TABLE OF CONTENTS

Contents	Page
<b>SECTION I GENERAL INFORMATION</b> .....	<b>1-1</b>
<b>1-1 INTRODUCTION</b> .....	<b>1-1</b>
1-1.1 Contacting Sage Instruments .....	1-1
<b>1-2 INITIAL INSPECTION</b> .....	<b>1-2</b>
<b>1-3 TYPOGRAPHICAL CONVENTIONS</b> .....	<b>1-2</b>
<b>SECTION II PREPARING FOR OPERATION/POWER-UP</b> .....	<b>2-1</b>
<b>2-1 AC POWER VERSION</b> .....	<b>2-1</b>
<b>2-2 DC POWER VERSION</b> .....	<b>2-2</b>
<b>2-3 SUPPLYING POWER AC/DC</b> .....	<b>2-2</b>
<b>2-4 COLD BOOTING</b> .....	<b>2-3</b>
2-4.1 Hardware Cold-Boot .....	2-4
<b>2-5 VENTILATION</b> .....	<b>2-4</b>
<b>2-6 INTERIOR ACCESS</b> .....	<b>2-4</b>
<b>2-7 SERIAL NUMBER</b> .....	<b>2-4</b>
<b>SECTION III FRONT PANEL OPERATION</b> .....	<b>3-1</b>
<b>3-1 SPECIAL FUNCTION KEYS</b> .....	<b>3-2</b>
3-1.1 STO Key .....	3-2
3-1.2 RCL Key .....	3-3
3-1.3 RCL NXT Key .....	3-3
3-1.4 ENT Key .....	3-3
3-1.5 CLR Key .....	3-3
3-1.6 HELP Key .....	3-4
<b>3-2 MAIN FUNCTION KEYS</b> .....	<b>3-4</b>
3-2.1 Trunk Type Function Key .....	3-4
3-2.2 Dial/Ring Function Key .....	3-6
3-2.3 Return Loss Function Key .....	3-8
3-2.4 Send Tone Function Key .....	3-10
3-2.5 Measure Tone Function Key .....	3-11
3-3.6 Measure Noise Function Key .....	3-11
<b>3-3 CONFIGURATOR PANELS</b> .....	<b>3-13</b>
<b>3-4 TEST CORDS AND FRONT PANEL JACKS</b> .....	<b>3-14</b>
<b>SECTION IV PCM OPERATION</b> .....	<b>4-1</b>
<b>4-1 CHANNELS AND TEST DIRECTION</b> .....	<b>4-2</b>
4-1.1 Test Mode .....	4-2
4-1.2 Test Direction .....	4-3
4-1.3 Clock .....	4-3
4-1.4 Setup .....	4-3
<b>4-2 SLC-96 SETUP</b> .....	<b>4-5</b>
4-2.1 SLC-96: Defined .....	4-6
4-2.2 SLC-96: Central Office Terminal/Remote Terminal .....	4-6
<b>4-3 HOW TO MONITOR A T1 SPAN</b> .....	<b>4-7</b>

## Table of Contents

---

Contents	Pages
<b>4-4 HOW TO MONITOR BOTH DIRECTIONS ON A T1 SPAN .....</b>	<b>4-8</b>
<b>4-5 TERMINATING A T1 SPAN FOR OUT-OF-SERVICE TESTING .....</b>	<b>4-9</b>
<b>4-6 DROP AND INSERT TESTING ON A T1 SPAN .....</b>	<b>4-10</b>
<b>4-7 HOW TO DEFINE YOUR OWN ON/OFF-HOOK STATUS .....</b>	<b>4-12</b>
<b>4-8 HOW TO SELECT FOREIGN EXCHANGE SUPERVISION .....</b>	<b>4-13</b>
<b>4-9 DROP AND INSERT TEST CORD CONNECTIONS AT A T1 CSU .....</b>	<b>4-14</b>
<b>SECTION V OPTION MENU NUMBERS .....</b>	<b>5-1</b>
<b>5-1 OPTION MENU #: 1 MODIFY DIAL/RING .....</b>	<b>5-3</b>
5-1.1 MF or DTMF Digits .....	5-3
5-1.2 DP Digits .....	5-5
5-1.3 Ring Generator .....	5-6
<b>5-2 OPTION MENU #: 2 SEND DIGIT SEQUENCES .....</b>	<b>5-8</b>
5-2.1 Sending a Call More Than 18 Digits Long .....	5-11
<b>5-3 OPTION MENU #: 3 REMOTE CONTROL .....</b>	<b>5-12</b>
5-3.1 Setup .....	5-12
5-3.2 Terminal Selection and Reporting .....	5-14
<b>5-4 OPTION MENU #: 4 DIGIT RECEIVER .....</b>	<b>5-16</b>
5-4.1 Setup .....	5-16
5-4.2 Receive .....	5-19
5-4.3 Analyze .....	5-20
<b>5-5 OPTION MENU #: 5 RING LOAD .....</b>	<b>5-21</b>
5-5.1 Setup .....	5-21
<b>5-6 OPTION MENU #: 6 DC VOLT/AMP METER .....</b>	<b>5-22</b>
5-6.1 Loop and Ground Start Measurements .....	5-22
5-6.2 E&M Measurements .....	5-24
<b>5-7 OPTION MENU #: 7 SUPERVISION THRESHOLDS .....</b>	<b>5-25</b>
5-7.1 Loop Supervision Thresholds Other Than 48 VDC .....	5-26
5-7.2 24V DC: E&M Supervision Thresholds .....	5-27
<b>5-8 OPTION MENU #: 8 SUPERVISION MONITOR .....</b>	<b>5-29</b>
5-8.1 Analog Connections .....	5-29
5-8.2 PCM Connections .....	5-31
<b>5-9 OPTION MENU #: 9 WINK TIMING .....</b>	<b>5-33</b>
<b>5-10 OPTION MENU #: 10 FREQUENCY SWEEP .....</b>	<b>5-35</b>
5-10.1 Setup .....	5-35
5-10.2 Sweep .....	5-37
<b>5-11 OPTION MENU #: 11 IMPULSE NOISE &amp; HITS .....</b>	<b>5-38</b>
5-11.1 Setup .....	5-38
5-11.2 Measure .....	5-41
<b>5-12 OPTION MENU #: 12 WINK MARGINING .....</b>	<b>5-42</b>
<b>5-13 OPTION MENU #: 13 PHASE &amp; AMPLITUDE JITTER .....</b>	<b>5-43</b>
<b>5-14 OPTION MENU #: 14 SET TIME AND DATE .....</b>	<b>5-45</b>
<b>5-15 OPTION MENU #: 15 BEEP ON ERR? .....</b>	<b>5-46</b>
<b>5-16 OPTION MENU #: 16 DIGIT RECEIVER TIMEOUT .....</b>	<b>5-47</b>

<b>Contents</b>	<b>Page</b>
<b>5-17 OPTION MENU #: 17 ENVELOP DELAY .....</b>	<b>5-48</b>
5-17.1 Setup .....	5-49
5-17.2 Send .....	5-52
5-17.3 Repeat .....	5-53
<b>5-18 OPTION MENU #: 18 P/AR MEASUREMENT .....</b>	<b>5-55</b>
<b>5-19 OPTION MENU #: 19 4-TONE INTERMODULATION .....</b>	<b>5-57</b>
5-19.1 Example: 4-Tone IMD Test on a 4-Wire Circuit .....	5-59
<b>5-20 OPTION MENU #: 20 24 BIT DISPLAY .....</b>	<b>5-61</b>
<b>5-21 OPTION MENU #: 21 TOGGLE A/B BITS .....</b>	<b>5-62</b>
<b>5-22 OPTION MENU #: 22 ABSOLUTE DELAY .....</b>	<b>5-63</b>
5-22.1 Setup and Testing (Send Unit) .....	5-63
5-22.2 Setup and Testing (Repeater) .....	5-64
<b>5-23 OPTION MENU #: 23 SLC-96 CONTROL BITS .....</b>	<b>5-65</b>
5-23.1 Central Office Terminal (COT), Single Party Mode .....	5-65
5-23.2 Central Office Terminal (COT), Coin Mode .....	5-66
5-23.3 Central Office Terminal (COT), UVG, Ground Start Mode .....	5-67
5-23.4 Central Office Terminal (COT), UVG, Loop Start Mode .....	5-69
5-23.5 Central Office Terminal (COT), DID Mode .....	5-70
5-23.6 Remote Terminal (RT), Single Party Mode .....	5-71
5-23.7 Remote Terminal (RT), Coin Mode .....	5-71
5-23.8 Remote Terminal (RT), UVG, Ground Start Mode .....	5-71
5-23.9 Remote Terminal (RT), UVG, Loop Start Mode .....	5-72
5-23.10 Remote Terminal (RT), DID Mode .....	5-72
<b>5-24 OPTION MENU #: 24 POST TPT DELAY .....</b>	<b>5-73</b>
<b>5-25 OPTION MENU #: 25 FAR END RESPONDER .....</b>	<b>5-74</b>
5-25.1 Setting the TLP and Enabling Manual Sequence .....	5-74
<b>5-26 OPTION MENU #: 26 ROTL/RESPONDER .....</b>	<b>5-77</b>
5-26.1 Setting the TLP .....	5-77
5-26.2 Tests .....	5-78
5-26.3 Results .....	5-81
<b>5-27 OPTION MENU #: 27 ROTL INTERROGATOR .....</b>	<b>5-83</b>
<b>5-29 OPTION MENU #: 29 CALL 102 LINE .....</b>	<b>5-88</b>
<b>5-30 OPTION MENU #: 30 ADJUST TLP .....</b>	<b>5-91</b>
<b>5-31 OPTION MENU #: 31 SEND HOOK FLASH .....</b>	<b>5-93</b>
<b>5-32 OPTION MENU #: 32 DIAL-UP TESTLINE .....</b>	<b>5-94</b>
<b>5-33 OPTION MENU #: 33 DIAL-UP SWEEP .....</b>	<b>5-95</b>
<b>5-34 OPTION MENU #: 34 SELECT REPORTS .....</b>	<b>5-96</b>
<b>5-35 OPTION MENU #: 35 DUAL TONE SENDER .....</b>	<b>5-98</b>
5-35.1 Setup .....	5-98
5-35.2 Preset .....	5-100
5-35.3 Send .....	5-100
<b>5-37 OPTION MENU #: 37 LINE STATUS .....</b>	<b>5-101</b>
<b>5-39 OPTION MENU #: 39 REMOTE AUDIO .....</b>	<b>5-102</b>
<b>5-40 OPTION MENU #: 40 SEND PCM ALARMS .....</b>	<b>5-104</b>
5-40.1 Send Alarm .....	5-105
5-40.2 Skew Clock .....	5-105
<b>5-41 OPTION MENU #: 41 READ T1 VOLTAGE .....</b>	<b>5-106</b>

## Table of Contents

---

Contents	Page
<b>5-42 OPTION MENU #: 42 T1 WANDER .....</b>	<b>5-108</b>
<b>5-43 OPTION MENU #: 43 T1 ERROR COUNTERS .....</b>	<b>5-110</b>
5-43.1 Example: MON 1&2 Mode .....	5-110
<b>5-44 OPTION MENU #: 44 T1 ERROR HISTORY .....</b>	<b>5-112</b>
5-44.1 Example: MON 1&2 Mode .....	5-112
5-44.2 View .....	5-113
5-44.3 Print .....	5-113
<b>5-45 OPTION MENU #: 45 T1 ERROR INJECT .....</b>	<b>5-114</b>
5-45.1 Setup .....	5-115
5-45.2 Rate .....	5-116
<b>5-46 OPTION MENU #: 46 DS-1 BIT ERROR RATE .....</b>	<b>5-117</b>
5-46.1 Testing between two COs .....	5-117
5-46.2 Setup .....	5-119
5-46.3 Test .....	5-124
5-46.4 History .....	5-129
<b>5-48 OPTION MENU #: 48 CSU EMULATION .....</b>	<b>5-131</b>
5-48.1 DS-1 Loopback .....	5-131
5-48.2 Line Build-Out .....	5-133
5-48.3 Current .....	5-133
5-48.4 Input .....	5-133
<b>5-52 OPTION MENU #: 52 PSQM DIRECTOR (VOIP).....</b>	<b>5-134</b>
52-1 Setup .....	5-134
52-2 Test .....	5-136
52-3 Results .....	5-136
<b>5-53 OPTION MENU #: 53 FAR PSQM RESPONDER (VOIP).....</b>	<b>5-138</b>
53-1 Setup .....	5-138
<b>5-55 OPTION MENU #: 55 FRACTIONAL T1 BERT .....</b>	<b>5-139</b>
5-55.1 Setup .....	5-140
5-55.2 Test .....	5-141
5-55.3 History .....	5-145
<b>5-56 OPTION MENU #: 56 DS-0 BIT ERROR RATE .....</b>	<b>5-147</b>
5-56.1 Setup .....	5-148
5-56.2 Test .....	5-149
5-56.3 History .....	5-152
<b>5-57 OPTION MENU #: 57 DS-0 LOOPBACK .....</b>	<b>5-153</b>
5-57.1 Digital Loopback .....	5-153
5-57.2 VF Loopback .....	5-154
<b>5-58 OPTION MENU #: 58 DDS BIT ERROR RATE .....</b>	<b>5-155</b>
5-58.1 Setup .....	5-155
5-58.2 Test .....	5-160
5-58.3 History .....	5-168
<b>5-59 OPTION MENU #: 59 ECHO CANCELLER DISABLE.....</b>	<b>5-170</b>
<b>5-60 OPTION MENU #: 60 HUM FILTER .....</b>	<b>5-172</b>
<b>5-64 OPTION MENU #: 64 GND-ST COIN PHONE.....</b>	<b>5-173</b>
<b>5-65 OPTION MENU #: 65 ATME FAR END RESPONDER .....</b>	<b>5-174</b>

<b>Contents</b>	<b>Page</b>
<b>5-66 OPTION MENU #: 66 ATME DIRECTOR</b> .....	<b>5-176</b>
5-66.1 Setup.....	5-176
5-66.2 Testing.....	5-179
5-66.3 View.....	5-180
<b>5-69 OPTION MENU # 69 FAR 23 TONE RESPONDER</b> .....	<b>5-181</b>
<b>5-70 OPTION MENU #: 70 23 TONE DIRECTOR</b> .....	<b>5-182</b>
5-70.1 Setup.....	5-182
5-70.2 Test.....	5-183
5-70.3 Results.....	5-183
<b>5-71 OPTION MENU #: 71 23 TONES TEST</b> .....	<b>5-185</b>
5-71.1 Setup.....	5-186
5-71.2 View.....	5-186
<b>5-72 OPTION MENU # 72 SS-7 LEVEL 2 ANALYSIS</b> .....	<b>5-188</b>
5-72.1 Setup.....	5-188
5-72.2 Test.....	5-191
5-72.3 Level 2 History.....	5-192
<b>5-73 OPTION MENU # 73 SS-7 CALL TRACE</b> .....	<b>5-194</b>
5-73.1 Setup.....	5-194
5-73.2 Test.....	5-200
5-73.3 Review.....	5-202
<b>5-75 OPTION MENU #: 75 REMOTE UPGRADE</b> .....	<b>5-206</b>
5-75.1 Installing Sage Software Upgrade Files on a Hard Disk.....	5-206
5-75.2 Downloading Software to the 935AT from a Computer.....	5-207
5-75.3 Downloading Software to the 935AT Remotely Using a Modem.....	5-208
<b>5-80 OPTION MENU #: 80 KEYBOARD LOCK OUT</b> .....	<b>5-212</b>
<b>5-87 OPTION MENU #: 87 TPT BURST LENGTH</b> .....	<b>5-213</b>
<b>5-89 OPTION MENU #: 89 PRINTER HAND SHAKE</b> .....	<b>5-214</b>
<b>5-91 OPTION MENU #: 91 SOFTWARE VERSION</b> .....	<b>5-216</b>
<b>5-92 OPTION MENU #: 92 RESET 930</b> .....	<b>5-217</b>
<b>5-93 OPTION MENU #: 93 TEST DISPLAY</b> .....	<b>5-218</b>
<b>5-94 OPTION MENU #: 94 LIST OPTIONS</b> .....	<b>5-219</b>
<b>5-95 OPTION MENU #: 95 DRY CIRCUIT</b> .....	<b>5-220</b>
<b>5-97 OPTION MENU #: 97 HOLD CONTROL</b> .....	<b>5-221</b>
<b>SECTION VI REMOTE CONTROL OPERATION</b> .....	<b>6-1</b>
<b>6-1 INTRODUCTION</b> .....	<b>6-1</b>
<b>6-2 CONNECTIONS</b> .....	<b>6-1</b>
<b>6.3 935AT REMOTE CONTROL SETUP</b> .....	<b>6-2</b>
6-3.1 Baud Rate.....	6-3
6-3.2 Parity.....	6-3
6-3.3 Bit Number.....	6-3
<b>6-4 PRINTER MODE</b> .....	<b>6-4</b>
6-4.1 Supported Printer Configurations.....	6-4
6-4.2 Printer Applications.....	6-5
6-4.3 Setting Printer Mode Parameters.....	6-5

## Table of Contents

---

Contents	Page
6-4.4 Printing Test Results .....	6-6
6-4.5 Printer Handshake .....	6-8
6-4.6 Print Formats .....	6-8
<b>6-5 TERMINAL MODE .....</b>	<b>6-10</b>
6-5.1 Setting Terminal Mode Parameters .....	6-10
6-5.2 Terminal Keyboard Equivalents to the 935AT Keypad .....	6-11
6-5.3 Troubleshooting .....	6-11
<b>6-5 COMPUTER MODE .....</b>	<b>6-10</b>
6-6.1 Setting Computer Mode Parameters .....	6-12
6-6.2 Computer Keyboard Equivalents to the 935AT Keypad .....	6-13
6-6.3 Input to the 935AT .....	6-15
6-6.4 Output from the 935AT .....	6-15
6-6.5 Display Line Formats .....	6-16
<b>6-7 PROGRAMMERS NOTES .....</b>	<b>6-17</b>
6-7.1 Initializing the 935AT .....	6-17
<b>6-8 HELP MENU .....</b>	<b>6-18</b>
<b>6-9 BELL CHARACTER .....</b>	<b>6-18</b>
<b>SECTION VII SPECIFICATIONS .....</b>	<b>7-1</b>
<b>7-1 DESCRIPTION .....</b>	<b>7-1</b>
<b>7-2 STANDARD FEATURES .....</b>	<b>7-1</b>
7-2.1 Level/Frequency .....	7-1
7-2.2 Noise Measurements .....	7-2
7-2.3 Return Loss .....	7-2
7-2.4 Supervision/Signaling .....	7-3
7-2.5 Dial Pulse Sender .....	7-3
7-2.6 MF/DTMF/DP Receiver and Analyzer .....	7-4
7-2.7 SF Supervision .....	7-4
7-2.8 DS-1 PCM Drop/Insert Options .....	7-4
<b>7-3 GENERAL .....</b>	<b>7-6</b>
<b>7-4 PURCHASE OPTIONS .....</b>	<b>7-6</b>
7-4.1 Fax/Modem TIMS Package (Option 935AT-100) .....	7-6
7-4.2 DS-0/DS-1 Bit Error Rate Testing (Option 935AT-200) .....	7-9



## SECTION I

### GENERAL INFORMATION

#### 1-1 INTRODUCTION

---

The **Sage 935AT Communications Test Set** is designed to perform a variety of voiceband and data tests on analog and digital trunk types.

This manual is designed to support the **5.xx** version of the **935AT** hardware and software. If you are running **4.xx** or an earlier version, some of the functions may operate differently from the directions described in this manual, while others will not be available to you. **SS7, 23 Tones Tests, MFCR2, and ATME Director/Responder**, for example, are available only with **5.xx**. If you require these functions, please contact **Sage instruments** for information on upgrading your software and hardware.

The manual is divided into seven sections. **Section I** provides general reference information on the **935AT**. **Section II** describes preparations for operation. **Section III** describes the operation of the front panel, including the main test functions. **Section IV** describes the operation of the optional PCM function. **Section V** describes the Option Menu, **Section VI** describes remote control operation, and **Section VII** lists the product specifications for the **935AT**.

#### 1-1.1 Contacting Sage Instruments

---

To contact **Sage Instruments** in writing, send correspondence to:

Sage Instruments, Inc.  
240 Airport Blvd.  
Freedom, CA 95019-2614

or send **Email** to:

sales@sageinst.com or support@sageinst.com

To reach our **Technical Support** and **Customer Service Departments** by phone, call:

(831) 761-1000, M-F, 9 a.m. to 5 p.m., Pacific Time.

or fax our **Technical Support** and **Customer Service Departments** any time at:

(831) 761-2452

To receive company and product information via the **World Wide Web**, visit our home page at:

<http://www.sageinst.com>

## ***Section I General Information***

---

Be sure to specify **Model 935AT** when asking for technical support. Customers located outside of the U.S. may also contact their nearest Sage distributor for assistance.

### **1-2 INITIAL INSPECTION**

---

Check the shipping carton for any visible signs of damage. Carefully unpack and remove the **935AT** from the shipping container. If the **935AT** is received in damaged condition, file a claim with the carrier and mail a copy of the claim to Sage Instruments.

The following items should be included in the shipping container:

1. **935AT** Communications Test Set.
2. **935AT** Operating Manual.
3. **AC** power cord. (If AC system has been purchased.)

Accessories may be shipped separately from the **935AT**, depending on their size. Check the shipping invoice against the contents of the received boxes.

### **1-3 TYPOGRAPHICAL CONVENTIONS**

---

In this manual, text appearing in bold **COURIER** typeface denotes information appearing on the **935AT** display panel.

## SECTION II

### PREPARING FOR OPERATION/POWER-UP

The tables shown on the next two pages describe the components of the **935AT** rear panel for all current units. If you purchased an earlier unit, some features, such as the Remote Audio Jack and Power Connector, may be located in slightly different locations. Others, such as the External Clock and Auxiliary RS-232C Connector will be absent.

#### 2-1 AC POWER VERSION

**Table 2-1 Rear Panel (AC Power Supply)**

Ground Lug	Grounds the 935AT chassis.
Fan Inlet	Provides ventilation to the 935AT. <u>Do not</u> obstruct fan inlet (or outlet holes at the top right).
RS-232C Connector	Enables connection to Data Terminal Equipment (DTE).
AC Power Connector	Connects the 935AT to a 115VAC power supply (depending on power supply type purchased) via an IEC type connector.
ON/OFF Power Switch	Turns the 935AT on and off.
Fuse Holder	Holds a 2-amp Slo-Blo fuse. Turn 1/4 turn counterclockwise to open.
PCM Rear Panel Access	Enables connection to a DSX from the rear panel. (Requires Purchase Option 935AT-320, Digital Rear Panel Access.)
Remote Audio Jack	Enables remote audio connection to a trunk under test via a separate dial-up line. (Requires Purchase Option 935AT-347, Remote Audio Monitor)
External Clock	The BNC jack enables the 935AT to connect to an external clock source via a coaxial cable.

## Section II Preparing For Operation/Power-Up

### 2-2 DC POWER VERSION

**Table 2-2 Rear Panel (DC Power Supply)**

Barrier Terminal Block	Connects 935AT to a -48V DC power supply
Fan Inlet	Provides ventilation to the 935AT. <u>Do not</u> obscure fan inlet (or outlet holes at the top right).
RS-232C Connector	Enables connection to Data Terminal Equipment (DTE).
ON/OFF Power Switch	Turns the 935AT on and off.
Fuse Holder	Holds a 2-amp Slo-Blo fuse. Turn 1/4 turn counterclockwise to open.
PCM Rear Panel Access	Enables connection to a DSX from the rear panel. (Requires Purchase Option 935AT-320, Digital Rear Panel Access.)
Remote Audio Jack	Enables remote audio connection to a trunk under test via a separate dial-up line. (Requires Purchase Option 935AT-347, Remote Audio Monitor)
External Clock	The BNC jack enables the 935AT to connect to an external clock source via a coaxial cable.

### 2-3 SUPPLYING POWER AC/DC

1. **AC version** (if your back panel looks like the one on the previous page)

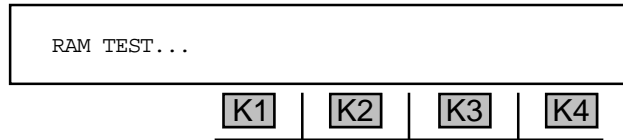
Connect the **935AT** to a **115/220V AC** power source via a **3-prong power cord**. The power connector is located next to the **red ON/OFF rocker switch** at the rear of the **935AT**.

**Warning!** If the rear panel of your **AC unit does not** look like the one on the previous page, you could seriously damage your unit if you do not connect it to the proper power source. Older units, which have a different rear panel and power supply, **do not** automatically switch between **115V AC** and **115V AC** operation but are equipped to operate only at a single voltage. You must check your unit's power requirements before plugging it in and turning it on. In addition, older units have a different rear panel configuration. If you are unsure of your unit's power requirements, contact the Sage Customer Service Department for assistance.

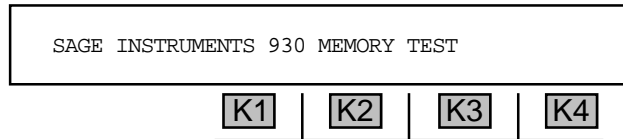
**DC version**

Connect the **935AT** to a **-48V DC** power source via 16 gauge wire. The wires connect at the two phillips head screws on the barrier terminal block.

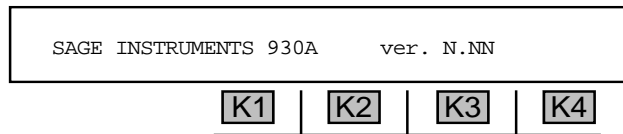
- 2. Toggle the red **ON/OFF rocker switch** at the rear of the **935AT** to **ON**. The **935AT** will run through a ram test:



After a moment the display will change to read:



If the memory check is successful the message: **MEMORY TEST** will change to **MEMORY OK!** If the memory test is successful, the display will change to read:



**N.NN** is the version of software installed in the unit. Note the status of the LEDs on the front panel. If an error has been detected, all of the LEDs will be lit. Turn the **935AT** off and perform a cold boot.

After a brief pause, the **935AT** will then advance to the last **Trunk Type** setup displayed when the unit was last powered-up.

To ensure optimal performance, do not store the **935AT** adjacent to other equipment that produced a lot of heat, dust, static, ozone, sparks, or strong magnetic fields.

**2-4 COLD BOOTING**

You can perform either a hardware cold-boot or a software cold boot. The procedure for performing a hardware cold boot is described below. A software cold-boot function has been added for the convenience of persons writing remote control software, and can be performed by using **OPTION MENU #: 92 SOFTWARE COLD-BOOT**. (Refer to **Section 5-92** for a complete description of this function.)

## Section II Preparing For Operation/Power-Up

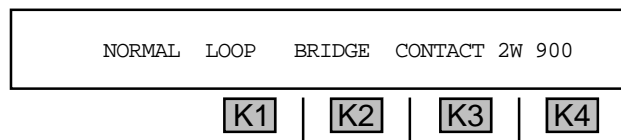
---

### 2-4.1 Hardware Cold-Boot

---

To perform a **hardware cold-boot**:

1. Turn the **935AT** off.
2. Hold down the **Trunk Type** function key located on the left side of the front panel.
3. Turn the **935AT** on. Do not release the **Trunk Type** function key until the display has scrolled all the way across the screen. The display will run through the same RAM and memory test messages that appear when you boot normally and then advance to the **Trunk Type** default display:



A successful hardware cold boot will return the **935AT** to its default settings and erase all stored items.

### 2-5 VENTILATION

---

The **935AT** is cooled by air drawn into the fan inlet on the lower left-hand side of the rear panel and expelled through the ventilation holes at the top right-hand corner.

To insure proper ventilation:

- Check that the vents are not obstructed during operation.
- Do not place the **935AT** rear panel down on thick carpeting during operation.
- Make sure that the operating environment is free of dust.
- Inspect the vents periodically for dust buildup.

### 2-6 INTERIOR ACCESS

---

Access to the interior of the **935AT** is obtained by removing the four phillips head screws (two on each side of the unit) that hold the top cover in place, and then lifting off the top panel. **DO NOT** attempt to gain access by removing the rear panel.

Since the **935AT** contains no user serviceable parts, interior access is not normally necessary unless you are performing a factory authorized field upgrade.

### 2-7 SERIAL NUMBER

---

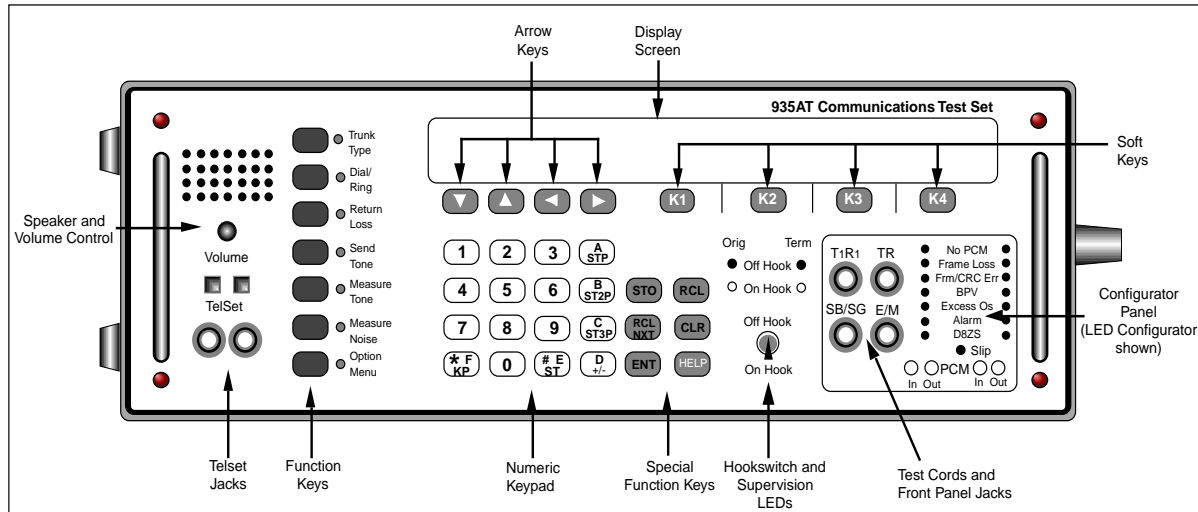
The product serial and model numbers are located on a serial tag at the bottom center of the rear panel.

## SECTION III

### FRONT PANEL OPERATION

This section provides information on the operation of the front panel keys, annunciator panels, switches, and test cord connections. The table below provides an overview of each of the front panel functions.

**Table 3-1 Front Panel Configuration**



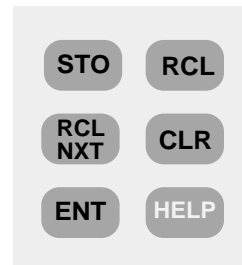
<b>Speaker and Volume Control</b>	Controls tone and voice volume.	
<b>Telset Jacks</b>	Allows for an external telephone monitor. The "cufflinks" are for use with a telephone lineman's test set (external butt-in set) 48 V battery is supplied in Dial/Ring. The telset is 4-wire with a 2950 Ohm impedance.	
<b>Main Function Keys</b>	The <b>7 black keys</b> control the main test functions of the <b>935AT</b> . (see <b>Section 3-2</b> for a description of each function)	
<b>Numeric Keypad</b>	The 16 white keys operate like a telephone keypad. They allow you to enter numerical data. The sign of a number can be changed by pressing the D+/- key.	
<b>Special Function Keys</b>	<b>STO Key</b>	Allows you to store data that has been input using the softkeys or numeric keypad. (see <b>Section 3-6.1</b> )
	<b>RCL Key</b>	Allows you to recall a test setup or other parameters that have been stored in memory. (see <b>Section 3-6.2</b> )
	<b>RCL NXT Key</b>	Advances to the storage location following the last location recalled. (see <b>Section 3-6.3</b> )
	<b>ENT Key</b>	Allows you to enter information once numeric data has been selected. (see <b>Section 3-6.4</b> )
	<b>CLR Key</b>	Clears or initializes sequences allowing new entries to be made. <b>DOES NOT</b> clear to zero. (see <b>Section 3-6.5</b> )
	<b>HELP Key</b>	Displays a series of screens leading you step-by-step through the function selected. (see <b>Section 3-6.6</b> )
<b>Hookswitch and Supervision LEDs</b>	The chrome switch allows you to toggle on/off hook. The LEDs show the status at the originate (ORIG) and terminate (TERM) ends.	
<b>Test Cords and Front Panel Jacks</b>	The jacks are used with the following configurations: TR -2-wire loop start, ground start, or reverse battery trunk TR&T1R1-4 wire trunk E/M-E&M test cord for E&M types I-IV SB/SG-signal battery/signal ground leads for E&M types II and IV PCM IN 1/PCM OUT 1-T1 carrier circuit-single direction PCM IN 2/PCM OUT 2-dual direction monitor or drop and insert	
<b>Configurator Panels</b>	Contains optional interface jacks and/or LED status lights depending on whether analog or PCM functions have been purchased. (see <b>Section 3-8</b> )	
<b>Soft Keys</b>	The four keys labelled <b>K1</b> through <b>K4</b> allow you to select from menu items that appear above each key on the display panel.	
<b>Arrow Keys</b>	Allow you to scroll through items listed on the display panel.	

Front Panel Operation

## Section III Front Panel Operation

### 3-1 SPECIAL FUNCTION KEYS

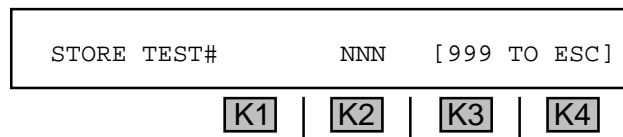
The **Special Function** keys are the six light gray keys located to the right of the **numeric keypad**.



#### 3-1.1 STO Key

To store a particular test setup, outpulse sequence, digit string, or any **Option Menu** setup:

1. Press the **STO** key. The display reads:



**Special  
Function  
Keys**

2. Use the **numeric keypad** to enter the number corresponding to the register location desired. **NNN** in the display above is the number of the storage location. This may be any number between **01** and **998**. The **935AT** automatically increments the storage location after each entry. [**999 TO ESC**] means enter 999 if you do not wish to store a test or setup.
3. Press the **ENT** key. Note that this function does not store current measurement results.

The **935AT** will retain what has been stored in its memory until the lithium battery on its CPU runs down, you overwrite that memory location, or you perform a cold-boot. Storing something new in a memory location automatically replaces the previous contents. A general description of the stored parameters for various test situations follows:

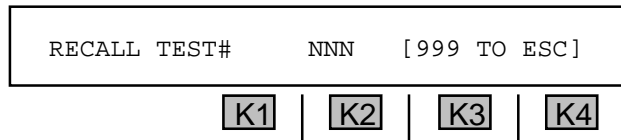
- In **Trunk Type**: All of the **Trunk Type** parameters listed on the display are saved exactly as they are shown. For **PCM** trunks this includes the undisplayed parameters.
- In **Dial/Ring**: The displayed digits, the outpulsing mode (MF, DTMF, or DP), and any modifications made in **OPTION MENU #: 1 MODIFY DIAL/RING** are saved. If a digit string has been stored with modifications, the outpulsing label (MF, DTMF, or DP) will be preceded by the ">" character.
- In **Return Loss**: All of the displayed parameters, including signal type, echo-suppress tone, and trans-hybrid loss are saved.
- In **Send Tone**: The level, frequency, and Tone On/Tone Off are saved.
- In **Measure Tone**: The relative zero level is saved.
- In **Measure Noise**: The filter type, balanced or noise-to-ground measurement, and relative zero are saved.
- In **OPTION MENU**: From the main Option Menu #: display, use the **STO** key to save all parameters specified within that option. The only exception to this is **OPTION MENU #: 1 MODIFY DIAL/RING**. Parameters set in this Option Menu #: are considered to be undisplayed parameters under the Dial/Ring function. (Refer to **Section 3, FUNCTION KEY OPERATION** for a description of the **Dial/Ring** function key.)



### 3-1.2 RCL Key

To recall a test setup or other parameters that have been stored in a register:

1. Press the **RCL** key. The display reads:



2. Use the **numeric keypad** to input the storage location number (between **00** and **998**) of the desired test setup.
3. Press **ENT** or any softkey (**K1-K4**) to recall the setup stored in that location at any time.

### 3-1.3 RCL NXT Key

If you stored setups or parameters in multiple registers, you can recall them in sequence using the **RCL NXT** key. Each time **RCL NXT** is selected, the storage location increments by one.

To display the setup stored in the next register in a series:

1. Hold down the **RCL NXT** key. While you hold the key, the register location is displayed.
2. Release the key to display the stored information. If a storage location has no information, the display reads: **LOCATION [NN] IS EMPTY.**

### 3-1.4 ENT Key

To accept data entered into the **935AT**:

1. Enter the data using the **numeric keypad** or make a selection from the display using the softkeys (**K1-K4**). Your entry options will vary depending on the function.
2. Press the **ENT** key. In some cases, you cannot advance to the next operation until you have completed your data entry and pressed the **ENT** key.

If the **935AT** is in **PRINTER** remote mode or **COMPUTER** remote mode with the proper connections to a printer, pressing **ENT** will print out the current display.

### 3-1.5 CLR Key

The **CLR** key is used to clear or initialize sequences and allow new entries to be made. It is not used to clear a numeric value to zero, which is done by entering a zero. Press the **CLR** key to clear sequences of variable length, such as a string of digits to be outputted in the **DIAL/RING** mode.

## Section III Front Panel Operation

### 3-1.6 HELP Key

Pressing the **HELP** key allows you to view and set up each step in a procedure separately and systematically. As the help function guides you through a procedure, you can select from setup and testing parameters listed above each of the softkeys (**K1-K4**). Cursors are displayed above your selections. (**HELP** is not available for all menus. It is most useful in navigating the remote control option.)

### 3-2 MAIN FUNCTION KEYS

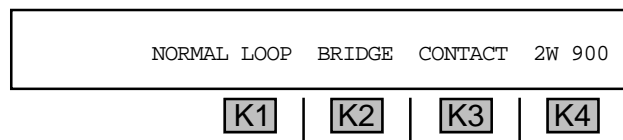
This section provides information on the operation of the function keys, located on the left of the front panel. (For information on the **Option Menu** function key, refer to **Section 5, Option Menu Numbers**.)

#### 3-2.1 Trunk Type Function Key

The **Trunk Type** function key is used to select and set up a trunk type (the type of circuit to which the **935AT** is connected). This procedure should be done before using any other function, and before performing any test or measurement.

To select a **trunk type**:

1. Press the **Trunk Type** function key. When power is first applied to the **935AT** it will default to the last-used configuration. The factory default display is shown below:



2. Use the **Up/Down Arrow** keys or **K1** to scroll through the available trunk types:

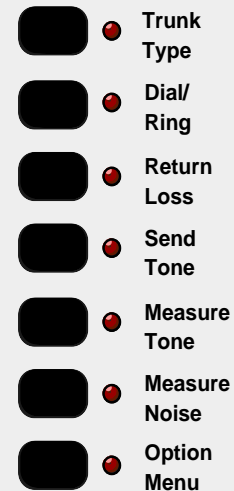
```
NORMAL LOOP
REVERSE LOOP
NORMAL GND-ST
REVERSE GND-ST
E&M (Types) I-V
(OPTIONAL TYPES) PCM SF WIDEBAND
```

For information on using the **Trunk Type** function key in **PCM** mode, refer to **Section 4, PCM Operation**.

#### 3-2.1.1 Setup for Analog Trunk Types

To set up an **analog** trunk type:

1. Press **K4** to select **2W 135-1200 OHM** or **4W 135-1200 OHM** impedance.



Main  
Function  
Keys

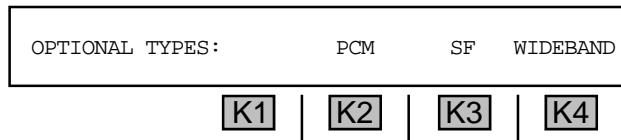
2. Press **K3** to toggle between **BATTERY** and **CONTACT** if you selected a **LOOP** or **GND-ST** trunk type, **OR** between **SEND-E** and **SEND-M** if you selected an **E&M** trunk type.
3. Press **K2** to toggle between **BRIDGE** or **TERM** (terminate) mode.

Changing trunk types or from 2W to 4W operation automatically places the **935AT** in the **BRIDGE** mode. In this mode, the **935AT** does not send supervision. The supervision lamp marked **Orig** shows the end of the circuit which the **935AT** would emulate if it were in **TERM** mode.

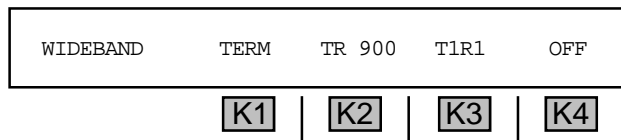
### 3-2.1.2 Setup for Wideband Operation

To set up the **935AT** for **wideband operation**:

1. Press the **Trunk Type** function key.
2. Use the **Up/Down Arrow** keys to scroll through the various trunk types until you see **OPTIONAL TYPES**. The display reads:



3. Press **K4** under **WIDEBAND**. The display reads:



4. Press **K2** to scroll through **TR 135**, **600**, **900** and, **1200**.
5. Press **K1** to toggle between **TR BRIDGE** and **TERM**.
6. Press **K4** to scroll through **T1R1 135**, **600**, **900**, **1200** and **OFF**.
7. Press **K3** to toggle between **T1R1 BRIDGE** and **TERM**.

### 3-2.1.3 Setup for Single Frequency Supervision

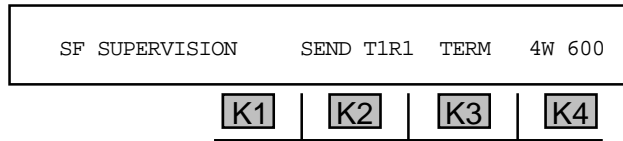
To setup **SF supervision**:

1. Press the **Trunk Type** function key.
2. Press **K1** or use the **Up/Down Arrow** keys to scroll through the various trunk types until you see the **OPTIONAL TYPES** display.

**Section III Front Panel Operation**

---

3. Press **K3** under **SF** to enter the Single Frequency supervision trunk type.



4. Press **K2** to toggle between sending on Tip/Ring (**SEND TR**) **OR** sending on Tip1/Ring1 (**SEND T1R1**).
5. Press **K4** to select the impedance (**2W 135-1200 Ohm** or **4W 135-1200 Ohm**). The **935AT** presently does not support 2-wire **SF** (Single Frequency) systems which use 2 tones (2404 and 2604 Hz, for example), nor can it be used to provide **SF** Supervision on **PCM** systems.
6. Press **K3** to toggle between **BRIDGE** and **TERM** operation.
7. Place the front panel **hookswitch** in the **Off Hook** position.

Supervision sends a **2604 Hz** tone to indicate an on-hook condition. **SF** is inherently a 4-wire trunk type and is now mainly used on special service trunks in the U.S. It has been largely displaced in the network by digital *CCIS and SS7 signaling types*.

**3-2.2 Dial/Ring Function Key**

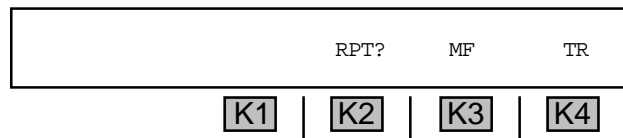
---

(Use this function with **OPTION MENU #: 1 MODIFY DIAL RING**, **OPTION MENU #: 2 SEND DIGIT SEQUENCE**, and **OPTION MENU #: 50 BATCH MODE**.)

Entering the **Dial/Ring** function automatically sets the trunk type to **TERM**. Check or change the **TERM/BRIDGE** setting under the **Trunk Type** function key. (Refer to **Section 3-7.1**.)

To operate the **935AT** in **Dial/Ring** mode:

1. Place the front panel **hookswitch** in the **On Hook** position.
2. Press the **Dial/Ring** function key. A display similar to the following appears:



3. Use the **numeric keypad** to enter the digits to be dialed. The **Left Arrow** key is used to insert a one second pause into a digit sequence and appears on the display as a “-” between digits.
4. Press **K3** repeatedly to scroll through the outpulsing modes.

The available modes are:

- **MF** (multifrequency).\*
- **DTMF** (dual tone multifrequency).†
- **DP** (dial pulse). This mode is valid only in **CONTACT** mode or **PCM**; it is not available when simulating a Central Office (supplying battery).
- **RING** This mode is only available with *Purchase Option 935AT-330 Ring Generator/True REN-3 Load* installed and is only valid when supplying **BATTERY** or as an **FXO** channel in **PCM**.

1209 Hz	1336 Hz	1477 Hz	1633 Hz		1100 Hz	1100 Hz	1300 Hz	1500 Hz	1700 Hz	
1	ABC	DEF	A	697 Hz	1	2	4	7	ST3P	700 Hz
GHI	2	3	STP			3	5	8	STP	900Hz
4	JKL	MNO	B	770Hz			6	9	KP	1100 Hz
PRS	5	6	ST2P					0	ST2P	1300 Hz
7	TUV	WXY	C	852 Hz					ST	1500 Hz
*	Oper	#	D	941 Hz						
	0		+/-							

† **DTMF Tone Pairs**

\* **MF tone pairs**

Front Panel  
Operation

Changing the mode clears all digit sequences and resets all parameters to their default values.

5. Use the **numeric keypad** to enter the digits to be dialed. The **Left Arrow** key is used to insert a one second pause into a digit sequence and appears on the display as a “-” between digits.
6. Toggle the **hookswitch** to the **Off Hook** position. If you go off-hook before entering the digits to be dialed, the digits will be outpulsed as you dial.
7. Press **K2** under **RPT?** to tell the **935AT** to send the digits. The display changes to: **RPT!**

When sending **MF** digits, first enter a **KP** (key pulse), enter the numbers, and end with an **ST** (stop pulse). For example, an MF digit string could be **KP004155551212ST**.

8. Press **K1** under **MANUAL** to send if you are in **RING** mode. Ringing will continue as long as you press the button. (**K1** is inactive unless *Purchase Option 935AT-330* is installed.)

**K4** is inactive. Above it, the **935AT** indicates which leads are used for outpulsing: (**TR**, **T1R1**, **SEND-E**, **SEND-M**, **SEND AB**, **PCM 1** or **PCM 2**).

9. Use the **CLR** key to clear the display.

Entering the **Dial/Ring** function automatically sets the metallic trunk type to **TERM**. Check or change the **TERM/BRIDGE** setting under the **Trunk Type** function key. (Refer to **Section 3-7.1**.)

### Section III Front Panel Operation

---

#### 3-2.2.1 Storing and Recalling Phone Numbers in Dial/Ring

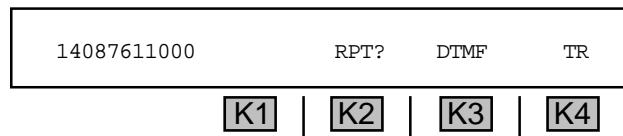
---

To store frequently used phone numbers for future recall and outpulsing, you must press the **STO** key. This will save the currently displayed digit sequence, its outpulsing mode (**MF**, **DTMF**, or **DP**), and any modifications which may have been made. The parameters may be stored in any of the 998 register locations (numbered from **01** to **998**).

*for example:*

To store a digit sequence in register location **17**:

1. Press the **Dial Ring** function key.
2. Use the **numeric keypad** to input a dial sequence (e.g. 14087611000). The display reads:



3. Press the **STO** key.
4. Select **17** using the **numeric keypad** and press **ENT**.

To recall the digit sequence:

1. Press the **RCL** key.
2. Select **17** using the **numeric keypad** and press **ENT**.

For **IDDD** applications in which a **CCITT No. 5 MF** sequence is being outpulsed, the required **KP2** pulse is equivalent to the **ST2P** pulse located on the **B ST2P** key on the **numeric keypad**. Such an **IDDD MF** sequence would appear as **ST2P11071738945ST**.

#### 3-2.3 Return Loss Function Key

---

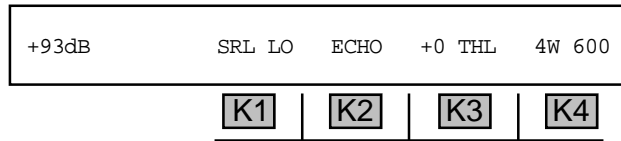
The **935AT** can measure return loss on **2W** or **4W** trunks. Measurements in **2W 135 Ohm** or **1200 Ohm** impedances are not available.

The **Return Loss** function is available only in the voice band trunk types. Typically, return loss is not a test requirement for Wideband due to the Private Line nature of Wideband, and because no 2/4-wire Hybrids exist in this type of facility.

To measure **return loss**:

1. Complete the initial trunk type setup. (Refer to **Section 3-2.1 Trunk Type Function Key**.)
2. Make sure the **935AT** is off-hook in the contact end of a loop trunk.

- Press the **Return Loss** function key. A display similar to the following appears:



Entering the Return Loss function automatically sets the metallic trunk type to **TERM**. Check or change the **TERM/BRIDGE** setting under the **Trunk Type** function key. (Refer to **Section 3-7.1.**)

- Press **K1** to cycle between **Echo Return Loss (ERL)**, **Singing Return Loss Low (SRL-LO)**, **Singing Return Loss High (SRL-HI)**, and **Structural Return Loss** measurements.

If you are in 2-wire mode, **TR TERM** is also available. In **TR TERM** you can use **K3** to scroll through the different type of terminations: **AC SHORT**, **AC OPEN**, **600 Ohm with 2.16 ufd (600+2uf)**, or **900 Ohm with 2.16 ufd (900+2uf)**.

- When measuring **structural return loss**, use the **numeric keypad** to enter the frequency of interest.

- A valid **tone** is between **20** and **5000 Hz**. The reading you get will not be valid unless echo suppressors/cancellers are disabled; these may be present on long distance circuits.

- Press **K2** to toggle the echo canceller on and off.

- Press the **Return Loss** function key to send the selected return loss signal, and receive and display measurements.

### 3-2.3.1 Transhybrid Loss Measurements

The amount of loss across a hybrid on a 4W circuit is used as a correction factor to the return loss measurement. The loss may be known from previous measurements (in which case it can simply be entered), or it may be measured by the **935AT**. In either case, the **935AT** will automatically correct its return loss readings. Pressing **K3** allows you to measure and enter the **THL** (transhybrid loss) correction.

To measure **Trans hybrid loss**:

- Connect the **935AT** to the 4-wire side of the hybrid and set the **trunk type** to **dry circuit**.
- Short the 2-wire side of the hybrid using a jumper cable. (If you cannot access the hybrid, leave the **THL** at the default of **0 dB** in step 4.)
- Press the **Return Loss** function key on the **935AT**. Use **ERL** or **OSC** with a frequency of **1004Hz**. This is mid-band for the measurement.

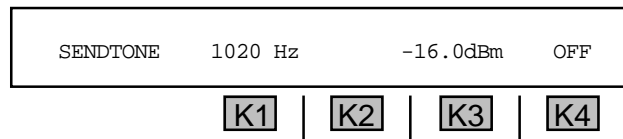
### Section III Front Panel Operation

4. Press **K3** to measure the **THL**. The value will appear over **K3**.
5. Press **K3** again and the **935AT** will prepare to set the measured value as the **THL** correction **OR** use the **numeric keypad** to enter the desired number when the cursor is flashing over the measured value.
6. Press **K3** again and the measured value will be accepted. The display reads: **MEAS THL**.

#### 3-2.4 Send Tone Function Key

To send a **tone** in **Voiceband** or **Wideband**:

1. Press the **Send Tone** function key. The display reads:



2. Press **K1** to change the frequency, **OR K3** to change the level.
3. Use the **numeric keypad** to enter the desired frequency or level and press **ENT**.

- A valid **frequency** in **voiceband** is between 20 Hz and 5000 Hz, and in **wideband** is between 20 Hz and 300 kHz.
- A valid **level** is between -60.0 dBm and +12 dBm.

4. Press **K4** to toggle between tone **ON** and tone **OFF**. If the tone is **ON**, the message above **K4** reads: **TR** (Tip/Ring), **T1R1** (Tip1/Ring1), **PCM1**, or **PCM2**, depending upon the trunk type and direction. If **OFF** is selected, no tone is sent.

The **935AT** can send tone while simultaneously performing other functions. When a tone is being sent with the **935AT** performing a different function, the LED beside the **Send Tone** function key will flash to alert you to the fact that tone is being sent.

If no tone is desired, return to the **Send Tone** function and press **K4**. The display reads: **OFF**. The tone selected in **Send Tone** is not sent in the **Dial/Ring** or **Return Loss** functions.

The **hookswitch** must be in the **Off Hook** position to send tones in the contact end of loop and ground start trunks.

5. Use the **Left/Right Arrow** keys to move the cursor from digit to digit.
6. Use the **Up/Down Arrow** keys to increment or decrement the digit beneath the cursor, or use the **numeric keypad** to enter the new frequency or level directly.

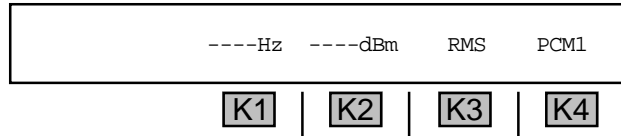
Entering the **Send Tone** function automatically sets the trunk type to **TERM**. Check or change the **TERM/BRIDGE** setting under the **Trunk Type** function key. (Refer to **Section 3-7.1**.)



### 3-2.5 Measure Tone Function Key

To measure a **received tone** in **Voiceband** or **Wideband**:

1. Press the **Measure Tone** function key. The display reads:



2. Press **K2** once to lock in the current measured value as the **0 dB** reference point. (Pressing **K2** again enables you to input a relative **0** using the **numeric keypad**.)
3. Press **K2** again to return the **935AT** to **dBm** measurement. The **935AT** displays measurements in **dBm** (absolute relative to 1 milliwatt), **dB** (relative to a measured 0), or **dBm0** (relative to a specified 0 or transmission level point).
4. Press **K3** to toggle between the **AVERAGE** and **RMS** detectors. **AVERAGE** is typically used when measuring tone only. **RMS** is used when measuring distorted tone or tone with noise.

**K4** is inactive. The display above it shows the input from which the measurements are being taken, for example, **TR** (Tip/Ring), **T1R1** (Tip1/Ring1) and, optionally, **PCM1** or **PCM2**, depending on which trunk type has been chosen. Accurate measurements can only be made if the proper impedance has been selected in trunk type mode.

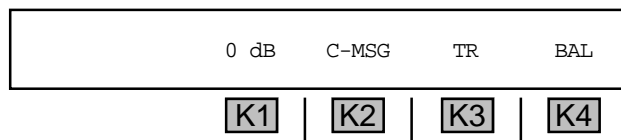
Initially the **935AT** displays the measurement in **dBm** and always returns to **dBm** when power is cycled. If the reading is too high or low, check to see that the reading is in dBm and not dB or dBm0.

In **Loop** and **Ground start** modes, the position of the hookswitch can affect the AC Termination and the measured level. Measurements in these trunk types should be made with the **935AT** off-hook.

### 3-3.6 Measure Noise Function Key

To measure **Noise** in **Voiceband** or **Wideband**:

1. Press the **Measure Noise** function key. The display reads:



2. Press **K2** to scroll through the weighting filters: **3K FLT** (3 kHz Flat), **C-MSG** (C-Message), **C-NOTCH**, or **S/N** (Signal-to-Noise). In Wideband, **15K FLT** (15 kHz Flat), **PROGRAM**, **50 K-BIT** and **E-FILTER** are also available filters. The **DSL** and **HDSL** technologies require a flat response out to approximately **100 kHz** using the **E-FILTER**.

**K3** is inactive, displaying the input signal source (**TR**, **T1R1**, **PCM1**, or **PCM2**).

### Section III Front Panel Operation

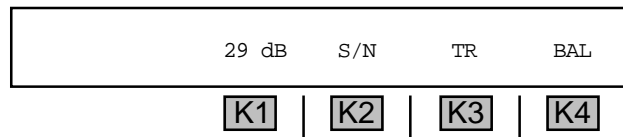
3. Press **K1** to scroll through and select a relative **dB**, **dBrnC**, or **dBrnC0** dB reference point, or to enter a **TLP** correction factor.
4. If you selected a **dBrnC0** reference point, scroll through the reference points until a flashing cursor is displayed, and use the **numeric keypad** to enter the level.

- A valid **reference point** is between **+82** and **-116 dBrnC0**.

5. **K4** toggles between **BAL** (balanced) or **N TO G** (Noise-to-Ground) measurements on analog trunks. On **PCM** trunks, the display shows the **CHANNEL** on which noise is being measured and **K4** is inactive on **PCM** trunks and during **S/N** measurements.
6. To measure noise other than **C-Notch**, use **Dial/Ring** mode to call the far-end Type-100 test line. This will place a quiet termination on the line.

To measure **Signal-to-Noise**:

1. Call the local milliwatt number to get a **1004 Hz** tone sent back. Alternately, you can contact someone at the other end of the circuit and have them send **1004 Hz** back.
2. Press the **Measure Noise** function key.
3. Press **K2** repeatedly to select **s/N**. The display reads:



If the holding tone is not present instead of the level, the display reads: **NO TONE**.

The **S/N** ratio measurement requires that a holding tone be present at the measuring end of the circuit. On 2-wire trunks this usually means making an end-to-end measurement with one test set supplying **1004 Hz** from one end and the other test set measuring the **S/N** at the other end. On a 4-wire trunk, the far-end can be looped back. In this case the **935AT** can generate a **1004 Hz** tone at the appropriate level and then measure the **S/N** ratio for the loop.

You can also set the relative zero for measurements in **dB**, using one weighting filter and then change to another filter. The display will then show the measurement in one filter relative to the other. This feature is particularly useful for measuring the quantization noise in **PCM**.

**dBrn** is referenced to **1 pico-watt (10<sup>-12</sup> watts)**.

3-3 CONFIGURATOR PANELS

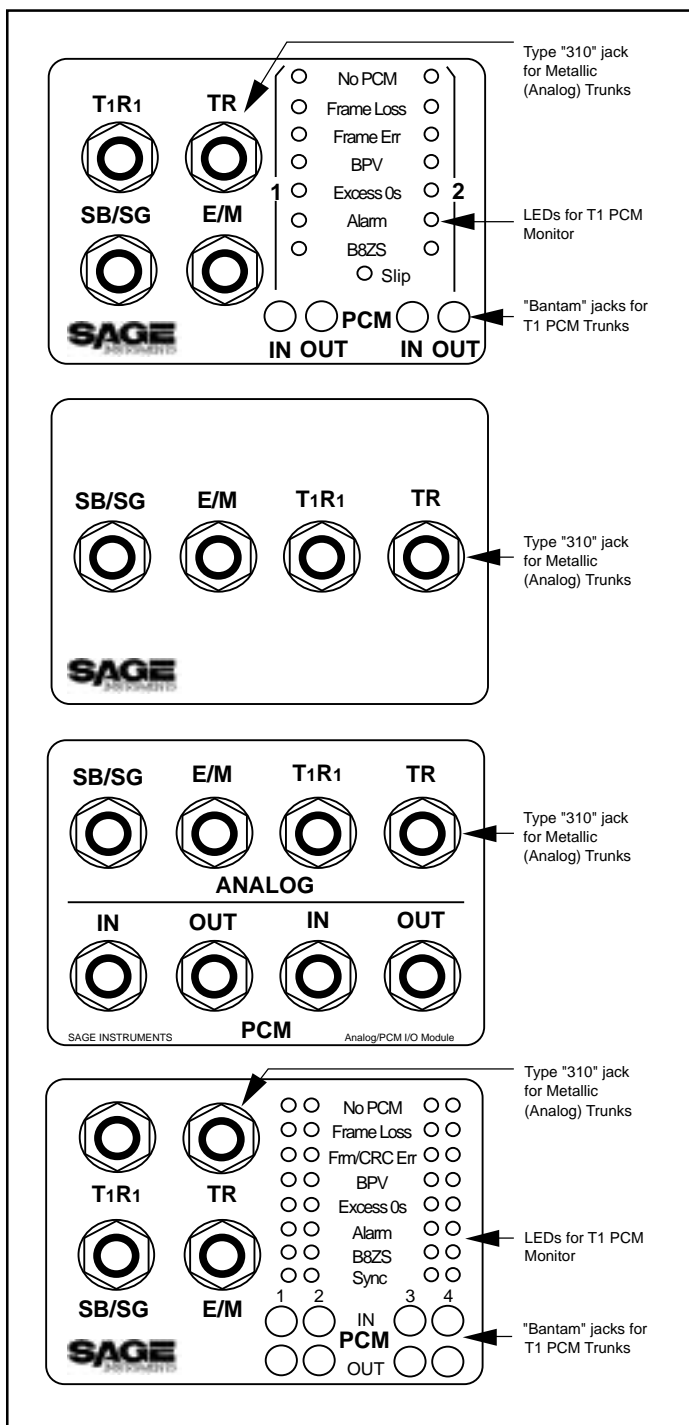


Figure 3-1  
Configurator Panels

The **LED Configurator** is the standard configurator for **PCM** units. LEDs indicate status and errors on the 2 **T1** lines (**PCM1** & **PCM2**).

This configurator also has 310-type jacks for the analog input/output that are labeled **SB/SG** (Signal Battery/Signal Ground), **E/M** (The “E”- and “M”-leads), **T/R** (Tip and Ring), and **T1/R1** (Tip1 and Ring1). The **E/M** and **SB/SG** leads are used for E&M signaling. **TR** and **T1R1** are used by all 4-wire analog trunks. All 2-wire signaling and transmission is done over **TR**.

The **Analog Configurator** is used in **935ATs** intended for entirely analog operation and have no PCM options. The 310-type jacks are for the analog input/output and are labeled **SB/SG** (Signal Battery/Signal Ground), **E/M** (The “E”- and “M”-leads), **T/R** (Tip and Ring), and **T1/R1** (Tip1 and Ring1). The **E/M** and **SB/SG** leads are used for E&M signaling. **TR** and **T1R1** are used by all 4-wire analog trunks. All 2-wire signaling and transmission is done over **TR**.

The **A/P Configurator** is intended for use in those units which have both analog and digital (**T1 PCM**) capability. The analog jacks are 310-style and they are labeled **SB/SG** (Signal Battery/Signal Ground), **E/M** (The “E”- and “M”-leads), **T/R** (Tip and Ring), and **T1/R1** (Tip1 and Ring1). The **PCM** jacks are bantam style and are labeled **PCM1 IN**, **PCM1 OUT**, **PCM2 IN**, **PCM2 OUT**.

The **SS-7 Configurator** is available with the **SS-7** line signaling purchased option. It is similar to the standard **LED Configurator**, except that there are four sets of LEDs that indicate the status and errors on four **T1** lines carrying **SS7** links. (**PCM1**, **PCM2**, **PCM3** & **PCM4**). These **PCM** lines connect to the **935AT** via the four sets of **PCM** bantam jacks.

This configurator also has 310-type jacks for the analog input/output that are labeled **SB/SG** (Signal Battery/Signal Ground), **E/M** (The “E”- and “M”-leads), **T/R** (Tip and Ring), and **T1/R1** (Tip1 and Ring1). The **E/M** and **SB/SG** leads are used for E&M signaling. **TR** and **T1R1** are used by all 4-wire analog trunks. All 2-wire signaling and transmission is done over **TR**.

Front Panel  
Operation

### **3-4 Test Cords and Front Panel Jacks**

---

You can connect the **935AT** to trunks under test in one of 2 ways: through test cords plugged in to the front panel jacks, or through wire wrap connectors attached at the **Analog** and **PCM** rear panel access ports located at the back of the test set.

#### **Test Cord Connections for a 2-Wire Loop Start Trunks**

Connect a 2-wire loop start, ground start, or reverse battery trunk to the **935AT** at the **310 jack** labeled **TR**.

#### **Test Cord Connections for 4-Wire Trunks**

Connect a 4-wire trunk to the **935AT** at the **310 jacks** labeled **TR** and **T1R1**.

If the trunk is an **E&M** trunk, the **E&M** test cord must be connected at the **310 jack** labeled **E/M** for **Type I**.

If **E&M Types II** through **IV** are being tested, the signal battery and signal ground leads must be connected at the **310 jack** labeled **SB/SG**.

#### **Test Cord Connections for PCM Trunks**

Connect a **T1** carrier circuit to the **935AT** at the **PCM** jacks. These **bantam jacks** allow for connection at **100 Ohms**. The jacks are labeled **PCM IN** (receive) and **PCM OUT** (transmit). The **Analog**, **LED** and **310 A/P** configurators allow for connection to two PCM trunks, while the **SS-7** configurator allows for connection to four PCM trunks.

Use the **PCM1** jack for single-direction testing. For dual-direction drop and insert testing, use **PCM1** and **PCM2**.

For **SS-7** with four links carrying **SS-7** data, use **PCM1**, **PCM2**, **PCM3**, and **PCM4**.

## SECTION IV

### PCM OPERATION

The **935AT** can operate on the normal **D4 Superframe** format **T1** carrier, as well as the **SLC-96** system and the Extended Superframe (ESF) format. The **935AT** will detect whether the T-Carrier is a **D4 Superframe** or **ESF** formatted signal, and set itself automatically when first plugged into the span at the **DSX**. The **935AT** does not set itself for **SLC-96** framing; this option must be set manually to work on a **SLC-96** span. (Refer to **Section 4-2, SLC-96 Set Up** and **Section 5-23, Option Menu #: 23 SLC-96 CONTROL BITS** for more information.) Once **SLC-96** framing has been selected, the **935AT** operates exactly the same as it does on any other **T1**.

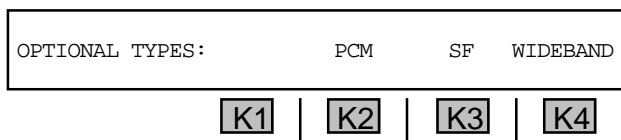
The factory **DS-1 (T1)** defaults are:

Impedance:	100 OHMS
Framing:	D4 SUPERFRAME
Signaling:	ROBBED-BIT
Line Coding:	AMI (Alternate Mark Inversion)/(bipolar)
Channel Numbering Sequence:	D3/D4
Supervision:	NORMAL (E&M)

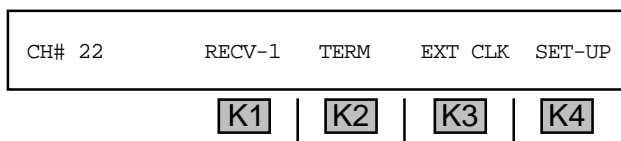
PCM  
Operation

To select **T1 (DS-1) PCM trunk type**:

1. Press the **Trunk Type** function key.
2. Press **K1** or the **Up/Down Arrow** keys until you reach the **OPTIONAL TYPES** display:



3. Press **K2** under **PCM**. The display below shows the factory default **PCM** display:



## 4-1 CHANNELS AND TEST DIRECTION

---

MON-1&2 and D&I modes (two transmitters and two receivers) are also available. This enables the 935AT to monitor a T1 span on both sides of a DSX simultaneously.

To change the PCM channel, use the **Up/Down Arrow** keys, or enter the number of the channel (1 to 24) from the **numeric keypad**. The **PCM** channel number to be tested is shown on the far left of the display. The factory default is **CH# 22**.

### 4-1.1 Test Mode

---

To select the **span test mode**:

1. Press **K2** under **TERM** from the main **PCM** display. The display advances to read:

SPAN:	TERMINATE	MON-1	MON-1&2	D&I
	<b>K1</b>	<b>K2</b>	<b>K3</b>	<b>K4</b>

2. Press the appropriate softkey (**K1-K4**) under the desired span type.

**TERMINATE** mode enables the 935AT to act as a channel bank or switch terminating one end of the span.

**ON-1** is used for monitoring one direction of transmission.

**MON-1&2** is used to monitor traffic in both directions simultaneously by activating both of the 935AT's receivers.

**D&I** (Drop & Insert) is used on live spans between two switches or multiplexers, etc. One of the 24 channels is dropped-out for testing while the other 23 pass through undisturbed.

If the 935AT is in either **MON-1&2** or **D&I** mode and **TERMINATE** or **MON-1** mode is selected, the display reads:

ARE YOU SURE?	YES	NO		
	<b>K1</b>	<b>K2</b>	<b>K3</b>	<b>K4</b>

3. Press **K4** under **NO** to return to the current mode **OR** press **K2** under **YES** to activate **TERMINATE** or **MON-1**.

### 4-1.2 Test Direction

To select **test direction**:

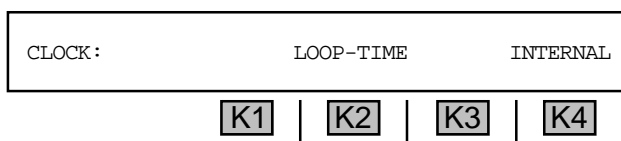
Press **K1** under **RECV-1** from the main **PCM** display to toggle between side 1 and side 2 in the **MON-1&2** or **D&I** mode without having to swap test cords around. If the **935AT** is in **TERMINATE** or **MON-1** mode, the key is inactive because only side 1 is receiving.

### 4-1.3 Clock

When the **935AT** is in **TERMINATE** mode, a transmit clock source may be chosen. The **935AT** can be loop-timed (**LOOP-TIME**) to the span clock, or it can supply the clock (**INTERNAL**).

To select the **EXT CLOCK**:

1. Press **K3** under **EXT CLK** in the main **PCM** display (when in **TERMINATE** mode only). The **CLOCK** display reads:



The cursor appears over the current selection.

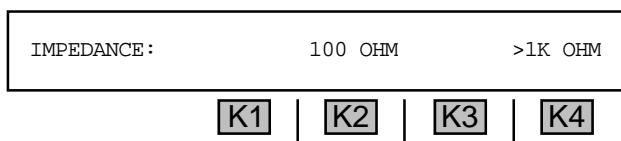
In **TERMINATE** mode, it is assumed that the T1 span you are terminating has been taken out of service for test purposes. With the other three modes it is assumed that live traffic may be on the span.

2. Press **K2** under **LOOP-TIME** **OR** **K4** under **INTERNAL** for a clock source.

### 4-1.4 Setup

To change the default setups or the setup you have previously entered:

1. Press **K4** under **SET-UP** from the main **PCM** display. The **SPAN** display reads:



The cursor appears above the current selection.

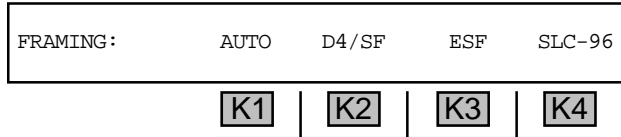
2. Use the **100 OHM** default at the **DSX** jacks (including the monitor jacks) or at the **CSU** or Office Repeater jacks. Use **>1K OHM** only in cases where your **DSX** does not supply isolation resistors.

If you leave the **935AT** in the **>1K OHM** position and connect it to the **DSX** monitor jacks (which already have 1000 Ohms of isolation), the signal will be distorted and cause error indications.

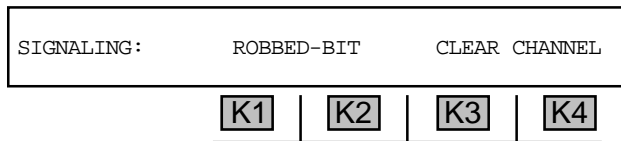
PCM  
Operation

**Section IV PCM Operation**

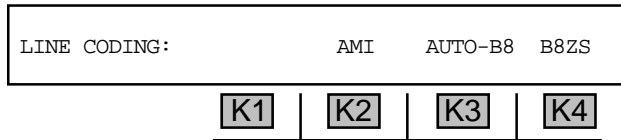
Continue scrolling by pressing the softkey (**K1-K4**) under your selection on the display **OR** press the **Up/Down Arrow** keys. The display reads:



3. Press **K1** to toggle **AUTO** on and off. **AUTO** lets the **935AT** determine what kind of span you are on. (For information on **SLC-96** framing, refer to **Section 3-2**.)
4. Press the softkey (**K1-K4**) under the desired framing choice. The display reads:

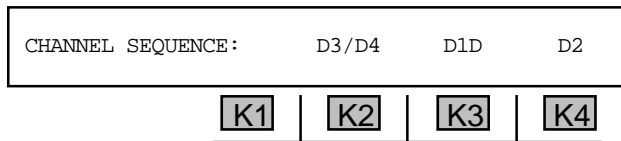


5. Press **K2**, **K3**, or **K4** to select a signaling type. The display reads:



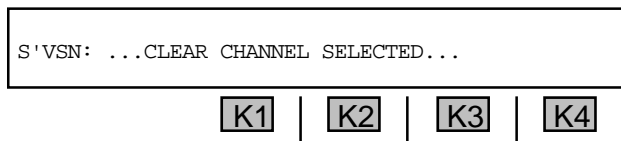
6. Press **K3** to toggle **AUTO-B8ZS** detection on or off. In auto mode, it will detect the **B8ZS** code in **AMI**, or lack of it in **B8ZS**, and automatically switch. Alternately, press **K2** to select **AMI** or **K4** to select **B8ZS**.

The display reads:



7. Press **K2** to select **D3/D4**, **K3** to select **D1D** **OR** **K4** to select **D2**.

If **CLEAR-CHANNEL** was selected, the next display reads:



This message remains on the display until you press a softkey. You will return to the main **PCM** setup display.



If **ROBBED BIT** was selected, the next display reads:

S'VSN:	DEFINED	NORMAL	FXS	FXO
	<b>K1</b>	<b>K2</b>	<b>K3</b>	<b>K4</b>

The default supervision is **NORMAL** and is equal to **E&M** signaling on digital switches. An on-hook is signaled by the A and B (or A, B, C and D) bits equalling a 0 state. An off-hook or busy is given by these bits equalling a 1 state.

8. Press **K1** under **DEFINED** to customize the on-hook/off-hook status.

**DEFINED** mode lets you define the on-and off-hook states to be any combination of A and B (or A, B, C and D) bits. If you change the **DEFINED** mode to other than A=B using DP (dial pulse), verify that the significant bit is also defined in Dial/Ring. See display below.

761-1000	RPT?	DP	SEND A
<b>K1</b>	<b>K2</b>	<b>K3</b>	<b>K4</b>

**FXO/FXS PCM Supervision** allows the **935AT** to simulate the office-end or station-end of a Foreign Exchange circuit (**FXO** or **FXS**). (Refer to **Section 4-8** for setup information in **FXO** or **FXS**.)

When you have made the final selection, the **935AT** returns to the main **PCM** display.

9. Select the proper supervision type for your T-Carrier span.

## 4-2 SLC-96 SETUP

If you chose **SLC-96** framing, the next display reads:

PCM1:	DEFINED	COT	RT
	<b>K1</b>	<b>K2</b>	<b>K3</b>

Press the appropriate softkey (**K1- K4**) and you will advance to the first **PCM** setup display. Select **DEFINED** to define your own setup, select **COT** to define the setup for Central Office Terminal operation, or select **RT** to define the setup for Remote Terminal operation.

## Section IV PCM Operation

---

### 4-2.1 SLC-96: Defined

---

To define the SLC-96 setup:

1. Press **K1** or **K2** under **DEFINED**. The display reads:

SELECT DIRECTION?	SEND	RECV	EXIT
<b>K1</b>	<b>K2</b>	<b>K3</b>	<b>K4</b>

2. Press **K2** or **K3** to select a direction and to setup the on-hook and off-hook states for **AB** bits. The display reads:

AB	ON-HK: 00	OFF-HK: 11	EXIT
<b>K1</b>	<b>K2</b>	<b>K3</b>	<b>K4</b>

3. Press **K4** under **EXIT** to go back one display and exit again to return to the main **PCM** setup display.

### 4-2.2 SLC-96: Central Office Terminal/Remote Terminal

---

To set up the **935AT** for **COT** or **RT** functioning:

1. Press **K3** under **COT** or **K4** under **RT** from the main **SLC** setup display. The new display reads:

COT TYPE:	SINGLE	COIN	UVG	MORE
<b>K1</b>	<b>K2</b>	<b>K3</b>	<b>K4</b>	

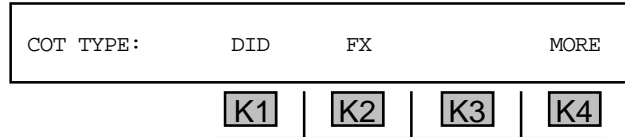
2. Press **K1** to select **SINGLE** party service **OR** press **K2** to select **COIN** service.

If **UVG** (universal voice grade) service is selected by pressing **K3**. The display reads:

UVG:	GROUND-START	LOOP-START	
<b>K1</b>	<b>K2</b>	<b>K3</b>	<b>K4</b>

3. Press **K1** or **K2** for **GROUND-START** **OR** press **K3** or **K4** for **LOOP-START**. You will be returned to the main **PCM** setup display.

- Press **K4** under **MORE** from the **COT TYPE** display. The display advances to:



- Press **K1** to select **DID** (direct inward dial) OR press **K2** to select **FX** (foreign exchange). Pressing **K4** toggles to the previous display.

(For operation and further setup instructions in **SLC-96** mode, see **Section 5-23, Option Menu #: 23, SLC-96.**)

### 4-3 HOW TO MONITOR A T1 SPAN

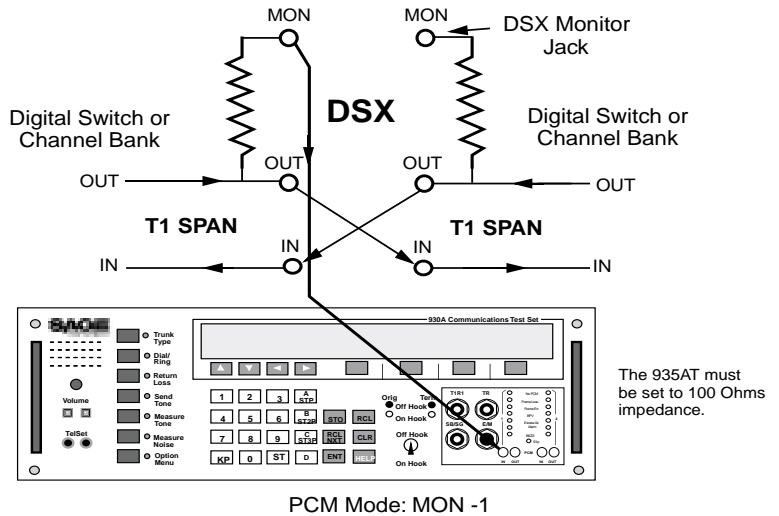
With this setup you may make measurements of anything such as level and frequency or noise. You may receive and analyze the digits of incoming calls. You can move the test cord to the other monitor jack and capture the digits of the outgoing calls; measure the wink timing; listen to the traffic on the speaker; view the status of the **A** and **B** bits on all **24 channels**; count **BPVs**, frame slips, frame errors, frame losses and **CRC** errors (**ESF**); or measure the **T1** voltage at the **DSX Monitor** level. You may not do anything active like place a call or send a tone or measure return loss.

PCM  
Operation

To monitor in a **single direction on a T1 span**:

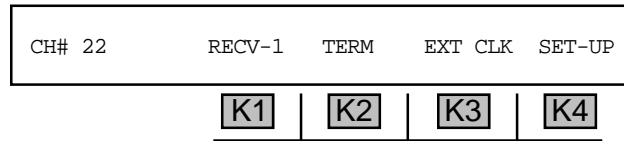
- Connect the test cords as shown in **Figure 4-1**.

The test cord connection is from the **935AT receiver (PCM IN 1)** to the **DSX** monitor jack.



## Section IV PCM Operation

The **935AT** display will look like the one below if it is set correctly.

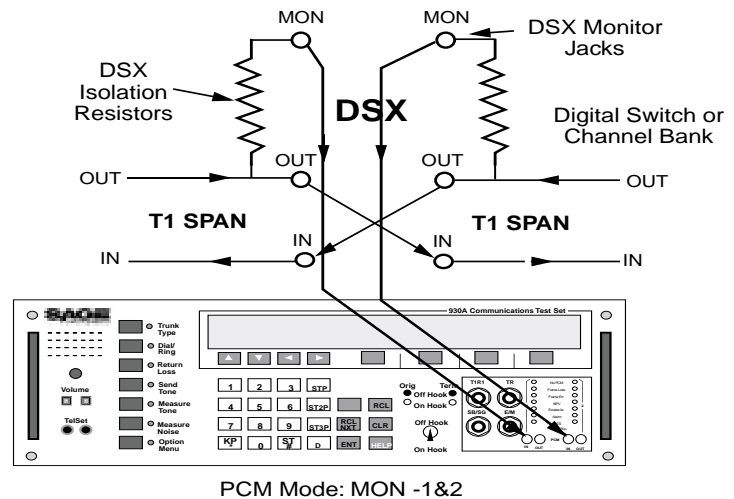


### 4-4 HOW TO MONITOR BOTH DIRECTIONS ON A T1 SPAN

You can monitor a T1 span on both sides of a DSX at the same time. To monitor a both directions on a T1 span:

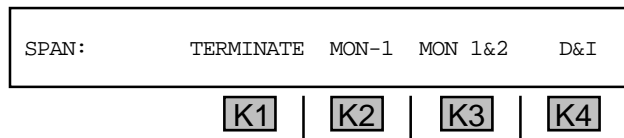
1. Connect the test cords as shown in **Figure 4-2**.

The test cord connections are from the **935AT** receivers (**PCM IN 1** and **PCM IN 2**) to the **DSX** Monitor jacks. The **935AT** has to be set to the **MON-1&2** mode. The process starts from the default **PCM** display.

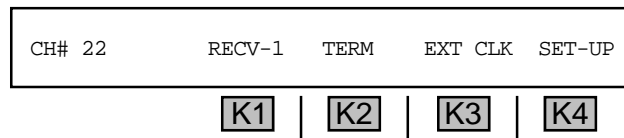


**Figure 4-2**  
**Monitoring Both Directions on a T1 Span**

1. Press **K2** under **TERM**. The display reads:



2. Press **K3** under **MON-1&2**. The display reads:



Any channel from **1** to **24** is valid; channel **22** is the default. The **935AT** can perform all of the measurements mentioned under single direction monitoring on both sides simultaneously.

- Press **K1** to toggle between **RECV-1** and **RECV-2**.

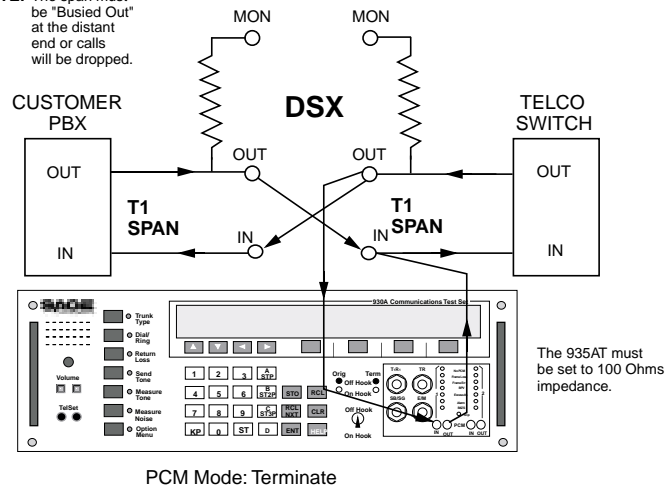
#### 4-5 TERMINATING A T1 SPAN FOR OUT-OF-SERVICE TESTING

For testing trunks on out-of-service T1 span lines (pre-cutover or turned down for maintenance), the **935AT** can generate as well as receive a **DS-1** signal. Once you have "Busied Out" the T1 span you are ready to connect the **935AT** toward the facility you want to test (switch, channel bank, etc.).

To terminate a T1 Span for Out-of-Service Testing:

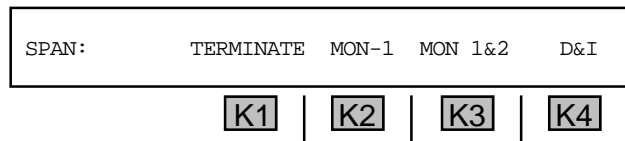
- Connect the test cords as shown in **Figure 4-3**:

**NOTE:** The span must be "Busied Out" at the distant end or calls will be dropped.

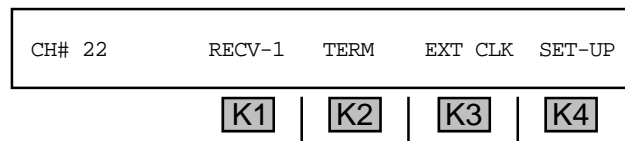


**Figure 4-3**  
Terminating a T1 Span for Out-of-Service Testing

- Press **K2** under **TERM**. The display reads:



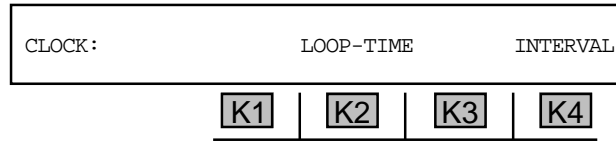
- Press **K1** to choose **TERMINATE** mode. The display reads:



When the **935AT** is in **TERMINATE** mode, a clock source for the **935AT** output may be chosen. The **935AT** can be loop-timed to the span clock, or you can have the **935AT** supply the clock.

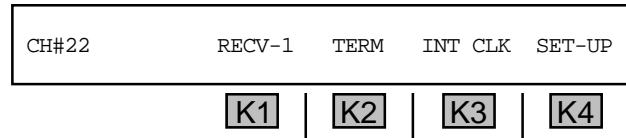
## Section IV PCM Operation

- Press **K3** under **EXT CLK** to select a clock source. The display reads:



A cursor appears over the current selection.

- Press **K4** under **INTERNAL**. The display reads:



Internal clock is only available in **TERMINATE** mode.

Trunk transmission and signaling can be tested completely before the trunk is placed in service using the **TERMINATE** mode to simulate either end of a circuit. Place the **935AT** in **EXT CLK** mode to simulate the loop side of the circuit toward a switch. To test toward the loop (simulate the switch toward the customer), set the **935AT** to **INT CLK** mode and transfer the test cords to the **DSX** jacks looking out toward the Office Repeater or the customer's **CSU**.

### 4-6 DROP AND INSERT TESTING ON A T1 SPAN

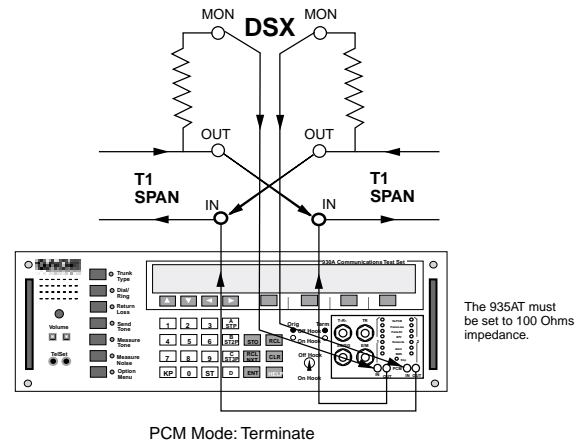
The procedure for Drop & Insert testing is a two stage process when using the **935AT**. Monitor both directions of transmission using the **MON-1&2** mode first, then begin testing.

- Connect the **935AT** to the **DSX** monitor jacks as shown in **Figure 4-4**.

#### **WARNING!**

Connecting the test cords from the **935AT**'s **PCM 1 OUT** to the span in-jack momentarily opens the span. You will need 100 Ohm termination plugs to plug into the opposite output jack of the **DSX** to keep the span from oscillating. If you do take a "hit" for any reason you will see a remote alarm indication on your **935AT** for a few seconds while the span reframes.

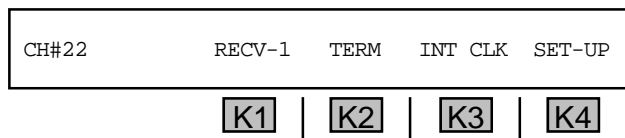
Generally, if you simultaneously plug the **935AT**'s **output cord** into the **in-jack** and the **loop termination** into the opposite **out-jack**, the indication will be a short burst of frame loss and the terminating equipment will reframe before it sends a remote alarm.



**Figure 4-4**  
Test Cord Connections for Drop and Insert Testing

Since both **PCM** signals are independent, it is best to connect each **935AT output** to span **input** and **100 ohm** termination separately so the results can be observed. If the message: **NO PCM!** appears on the display, unplug the cord from the jack and its corresponding **100 ohm** termination.

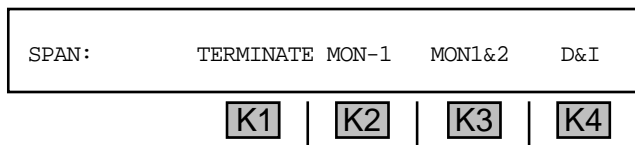
The **935AT** display should read:



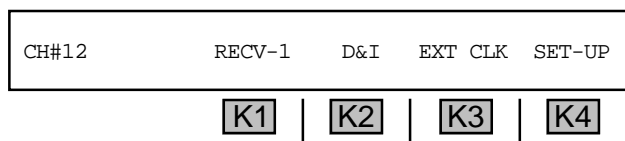
The valid channel numbers range between **1** and **24**. The above display shows **CH# 12** as an example only.

If the **935AT** reports **PCM** errors on either side, verify and correct the connection problem before proceeding.

2. Leave the **935AT** set to **MON-1&2** and connect test cords from **PCM OUT 1** and **PCM OUT 2** to the input jacks on the **DSX**.
3. Press **K1** under **MON 1&2** The display reads:



4. Press **K4** under **D&I** to drop the currently selected channel. The other 23 channels pass through undisturbed. Make sure the channel is idle before selecting **D&I**. The display reads:



This part of the process is "hitless," meaning once four test cords have been inserted with appropriate terminations, the danger of dropping the span has passed.

If you are in **D&I** and change channels, the **935AT** will revert back to **MON-1&2**. This is a safeguard against inadvertently interfering with a working channel.

4-7 HOW TO DEFINE YOUR OWN ON/OFF-HOOK STATUS

The **935AT** will allow you the flexibility to define your own on- and off-hook states of the **A/B/C/D** bits. The **NORMAL** supervision default is the most useful, followed by **FXS/FXO** supervision. You can redefine what the **935AT** sends and recognizes as an on- or off-hook.

To redefine what the hookswitch sends instead of the default conditions, start at the main **PCM** display:

CH#12	RECV-1	D&I	EXT CLK	SET-UP
<b>K1</b>	<b>K2</b>	<b>K3</b>	<b>K4</b>	

1. Press **K4** under **SET-UP**. The display reads:

IMPEDANCE:	100 OHM	>1K OHM	
<b>K1</b>	<b>K2</b>	<b>K3</b>	<b>K4</b>

2. Press the **Up Arrow** key to scroll through the setup parameters to the following display:

S' VSN:	DEFINED	NORMAL	FXS	FXO
<b>K1</b>	<b>K2</b>	<b>K3</b>	<b>K4</b>	

3. Press **K1** under **DEFINED** to define your own states. The display reads:

SELECT DIRECTION?	SEND	RECV	EXIT
<b>K1</b>	<b>K2</b>	<b>K3</b>	<b>K4</b>

4. Selecting the proper direction and depending on whether **D4 Superframe** or **ESF** is selected, you will advance to one of the following displays:

**D4/SF**

AB	ON-HK: 00	OFF-HK: 11	EXIT
<b>K1</b>	<b>K2</b>	<b>K3</b>	<b>K4</b>

**ESF**

ABCD	ON-HK: 0000	OFF-HK: 111	EXIT
<b>K1</b>	<b>K2</b>	<b>K3</b>	<b>K4</b>

PCM Operation



Note the cursor over the **A** bit position of the **ON-HK** state.

5. Change the state of the **ON-HK A**, **B**, **C** or **D** bits by moving the cursor with the **Left/Right Arrow** keys and then enter a **1** or a **0** from the **numeric keypad**. You can also change states using the **Up/Down Arrow** keys. Change the **OFF-HK** states by pressing **K3**; the cursor will move to the **OFF-HK** side.

When the **935AT** detects the off-hook bit pattern, the **OFF HOOK** LED lights. When the on-hook bit pattern is detected, the **ON HOOK** LED lights. If neither bit pattern is detected, the LEDs do not light. If the supervision LEDs on your front panel are not lit, the supervision bit patterns are probably incorrectly defined or not being received as you defined them.

Remember to reset the **935AT** back to **NORMAL** when you are finished testing in the **DEFINED** mode. You will have problems drawing dial tone and getting the supervision LEDs to read properly on a regular **PCM** channel if you do not.

#### 4-8 HOW TO SELECT FOREIGN EXCHANGE SUPERVISION

The FXO/FXS Supervision feature enables the **935AT** to operate on Foreign Exchange circuits on **PCM** trunks. FXO and FXS appear under the **PCM SET-UP** display for supervision.

##### Foreign Exchange Station (FXS)

In Foreign Exchange Station (**FXS**) mode, when the **935AT** is on-hook, it sends the Loop Idle bit pattern (A=0, B=1). When the **935AT** is off-hook, it sends the Ground-on-Ring bit pattern (A=0, B=0) until the far-end Foreign Exchange Office (FXO) returns Ground-on-Tip (A=0). The **935AT** will then send the Loop Closed bit pattern (A=1, B=1). This mode works equally with Loop Start and Ground Start offices.

The **935AT** assumes that the far-end is sending **FXO** supervision and interprets A=0 to mean Tip Ground (off-hook), and A=1 to mean No Tip Ground (on-hook). B=0 is interpreted as Ringing. B=1 is interpreted as No Ringing.

##### Foreign Exchange Office (FXO)

In Foreign Exchange Office (**FXO**) mode, when the **935AT** is on-hook, it will send the No Ground-on-Tip bit pattern (A=1, B=1). When the **935AT** is off-hook it will send the Ground-on-Tip bit pattern (A=0, B=1).

The **935AT** leaves the B bit set (B=1) to indicate No Ringing. You can send Ringing to the far-end by entering **OPTION MENU#: 21 TOGGLE A\B BITS** and setting the B bit to 0 manually. The B bit will revert to a 1 when the user exits the **TOGGLE A\B BITS** menu option.

The **935AT** assumes that the far-end is sending **FXS** supervision and interprets either Ring Ground (A=0, B=0) or Loop Closed (A=1, B=1) as an off-hook. This enables the **935AT** to operate with either Loop Start or Ground Start FXS equipment. The **935AT** interprets Loop Idle (A=0, B=1) as an on-hook. The unused bit pattern (A=1, B=0) is also interpreted as an on-hook.

## Section IV PCM Operation

---

To select foreign exchange supervision:

1. Press **K4** under **SET-UP** from the main **PCM** display. The first set up display reads:

IMPEDANCE:	100 OHM	>1K OHM	
<b>K1</b>	<b>K2</b>	<b>K3</b>	<b>K4</b>

2. Use the **Up Arrow** key to scroll to the **S'VSN** (supervision) display:

S'VSN:	DEFINED	NORMAL	FXS	FXO
<b>K1</b>	<b>K2</b>	<b>K3</b>	<b>K4</b>	

3. Press **K3** under **FXS** to select foreign exchange station **OR** **K4** under **FXO** to select a foreign exchange office.

If you selected **FXS**, the display reads:

FXS:	GROUND-START	LOOP-START	
<b>K1</b>	<b>K2</b>	<b>K3</b>	<b>K4</b>

If you selected **FXO**, the **FXS** message is replaced by **FXO**:

4. Press **K1** or **K2** to select a **ground start trunk**, **OR** press **K3** or **K4** to select a **loop start trunk**.

You will return to the main **PCM** display. The front panel hookswitch will now follow the type of Foreign Exchange supervision you selected. Remember to reset your supervision to **NORMAL** when you are finished testing in **FXS/FXO** so that you can operate on regular **PCM** channels.

### 4-9 DROP AND INSERT TEST CORD CONNECTIONS AT A T1 CSU

---

The test access jacks for monitoring at some **T1** Customer Service Units (**CSU**) are not wired the same as those in a **DSX** jack field. For this reason it is not recommended to use these jacks when connecting the **935AT** for Drop & Insert testing at a **CSU**.

In order to perform a **D&I** at the **CSU**, the **935AT** must pass the traffic from Equipment Out to Line In and from Line Out to Equipment In. This procedure should be done out-of-hours or after the users have been alerted. The same warning applies when removing the test cords.

The following diagrams describe the recommended procedure for connecting test cords between the **935AT** and a **T1 CSU** to do a **D&I** test.

1. Place the **935AT** in the **MON-1&2** mode with its settings at **100 OHM** impedance, **D4/SF** (or Extended Superframe as appropriate), **ROBBED-BIT** signaling, **AMI** line code, **D3/D4** channel sequence and **NORMAL** supervision. These are the most common settings. They can always be changed later.
2. Plug test cords into the two inputs of the **935AT** and then plug the other ends of these test cords into the **LINE OUT** and **EQPT OUT** jacks on the **CSU**. Refer to **Figure 4-5**.
3. Connect test cords from the **935AT** outputs to the **CSU LINE IN** and **EQPT IN** jacks. Refer to **Figure 4-6**.

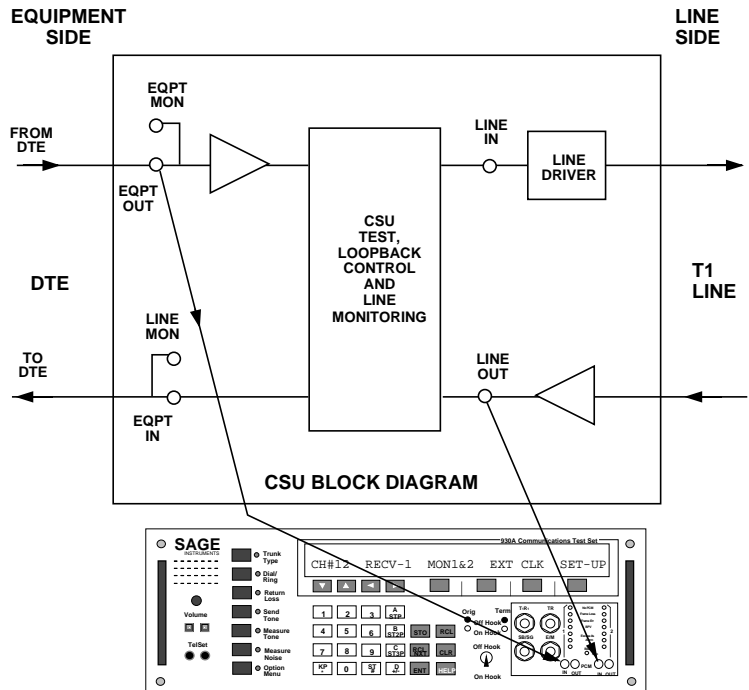


Figure 4-5  
Test Cord Connection at T1 CSU

- After a few seconds the remote alarm indication will clear and the **935AT** will frame up to the signal. If an **ESF** line is in use, the **935AT** will automatically frame up to it.
4. Select the channel to be tested.
  5. Place the **935AT** in the **D&I** mode.
  6. Press **K1** under **MON 1&2** to bring up the selections **MON-1**, **MON-1&2**, **D&I**.
  7. Press **K4** under **D&I** to select that mode.

At this point you can perform any test supported by the **935AT** on a Drop & Insert basis. This includes sending or receiving calls, transmission measurements, supervision monitoring and DS-0 Bit Error Testing.

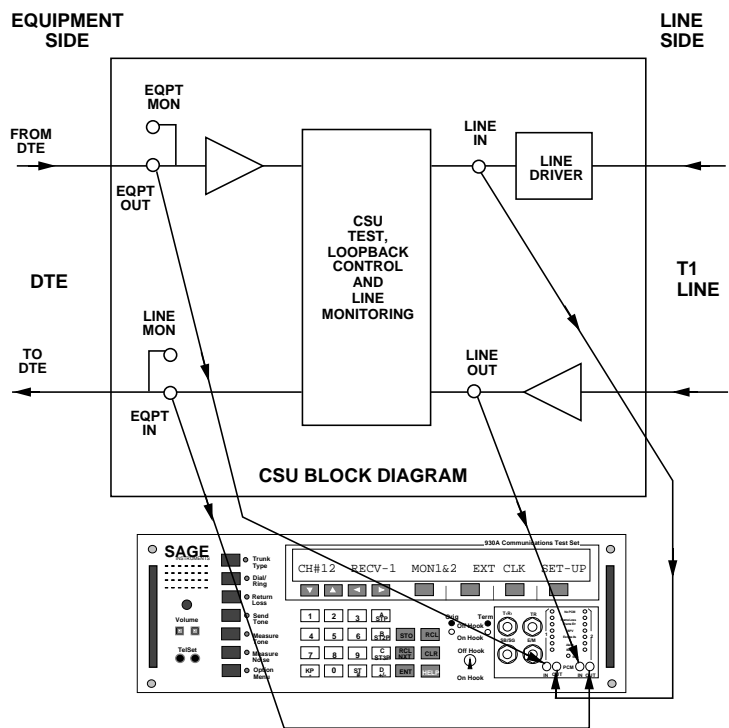


Figure 4-6  
CSU Line and EQPT JACKS

PCM  
Operation



## SECTION V

### OPTION MENU NUMBERS

The following chart lists each option menu number with its description and the purchase option necessary to receive that function if it is not a standard feature of the **935AT**.

Option Menu #	Description	Purchased Option Number
1	MODIFY DIAL/RING	STANDARD
2	SEND DIGIT SEQUENCES	STANDARD
3	REMOTE CONTROL	STANDARD
4	DIGIT RECEIVER	STANDARD
5	RING LOAD	PURCHASE OPTION 935AT-330
6	DC VOLT/AMP METER	STANDARD
7	SUPERVISION THRESHOLDS	STANDARD
8	SUPERVISION MONITOR	STANDARD
9	WINK TIMING	STANDARD
10	FREQUENCY SWEEP	STANDARD
11	IMPULSE NOISE & HITS	PURCHASE OPTION 935AT-100
12	WINK MARGINING	STANDARD
13	PHASE/AMPLITUDE JITTER	PURCHASE OPTION 935AT-100
14	SET TIME AND DATE	STANDARD
15	BEEP ON ERR?	STANDARD
16	DIGIT RECEIVER TIMEOUT	STANDARD
17	ENVELOPE DELAY	PURCHASE OPTION 935AT-100
18	P/AR MEASUREMENT	PURCHASE OPTION 935AT-100
19	4-TONE INTERMODULATION	PURCHASE OPTION 935AT-100
20	24 BIT DISPLAY	STANDARD
21	TOGGLE A/B BITS	STANDARD
22	ABSOLUTE DELAY	PURCHASE OPTION 935AT-100
23	SLC-96 CONTROL BITS	STANDARD
24	POST TPT DELAY	PURCHASE OPTION 935AT-110
25	FAR END RESPONDER	PURCHASE OPTION 935AT-110
26	ROTL/RESPONDER	PURCHASE OPTION 935AT-110
27	ROTL INTERROGATOR	PURCHASE OPTION 935AT-110
29	CALL 102 LINE	PURCHASE OPTION 935AT-110
30	ADJUST TLP	STANDARD
31	SEND HOOK FLASH	STANDARD
32	DIAL-UP TESTLINE	STANDARD
33	DIAL-UP SWEEP	STANDARD
34	SELECT REPORTS	STANDARD
35	DUAL TONE SENDER	STANDARD
37	LINE STATUS	STANDARD
39	REMOTE AUDIO	PURCHASE OPTION 935AT-347
40	SEND PCM ALARMS	STANDARD
41	READ T1 VOLTAGE	STANDARD
42	T1 WANDER	STANDARD
43	T1 ERROR COUNTERS	STANDARD
44	T1 ERROR HISTORY	STANDARD
45	T1 ERROR INJECT	STANDARD
46	DS-1 BIT ERROR RATE	PURCHASE OPTION 935AT-200

Option Menu Numbers

## Section V Option Menu Numbers

Option Menu #	Description	Purchased Option Number
48	CSU EMULATION	STANDARD
52	PSQM DIRECTOR	PURCHASE OPTION 935AT-110
53	FAR PSQM RESPONDER	PURCHASE OPTION 935AT-110
55	FRACTIONAL T1 BERT	PURCHASE OPTION 935AT-200
56	DS-0 BIT ERROR RATE	PURCHASE OPTION 935AT-200
57	DS-0 LOOPBACK	PURCHASE OPTION 935AT-200
58	DDS BIT ERROR RATE	PURCHASE OPTION 935AT-200
59	ECHO CANCELLER DISABLE	STANDARD
60	HUM FILTER	STANDARD
63	PCM ERROR HISTORY	STANDARD
64	GROUND START PHONE	STANDARD
65	ATME FAR END RESPONDER	PURCHASE OPTION 935AT-110
66	ATME DIRECTOR	PURCHASE OPTION 935AT-110
69	FAR 23 TONE RESPONDER	PURCHASE OPTION 935AT-100
70	23 TONE DIRECTOR	PURCHASE OPTION 935AT-100
71	23 TONES TEST	PURCHASE OPTION 935AT-100
72	SS-7 LEVEL 2 ANALYSIS	PURCHASE OPTION 935AT-210
73	SS-7 CALL TRACE	PURCHASE OPTION 935AT-210
75	REMOTE UPGRADE	STANDARD
80	KEYBOARD LOCKOUT	STANDARD
87	TPT BURST LENGTH	PURCHASE OPTION 935AT-110
89	PRINTER HAND SHAKE	STANDARD
91	SOFTWARE VERSION	STANDARD
92	SOFTWARE COLD-BOOT	STANDARD
93	TEST DISPLAY	STANDARD
94	LIST OPTIONS	STANDARD
95	DRY CIRCUIT	STANDARD
97	HOLD CONTROL	STANDARD

## Option Menu Function Keys

You can access the **Option Menu** functions in two ways:

1. Select the desired **Option Menu** number using the **numeric keypad** and press **ENT** or any softkey (**K1-K4**) to enter the **SETUP** display for that option.
2. Use the **Up/Down Arrow** keys to scroll up to **OPTION MENU #:99** or down to **OPTION MENU #:1** (the **Arrow** keys do not "wrap" from 99 to 1), and press **ENT** or any softkey (**K1-K4**) to enter the **SETUP** display for that option.

You can exit the **Option Menu** numbers by pressing the **Option Menu** function key or any of the other 6 function keys. In many cases, one of the selections in the display will be labeled **EXIT**; pressing the softkey (**K1-K4**) below it will also exit the option.

## 5-1 OPTION MENU #: 1 MODIFY DIAL/RING

**OPTION MENU #: 1 MODIFY DIAL/RING** is a standard feature that enables you to modify the **Dial/Ring** format.

To modify the **Dial/Ring** format:

1. Select the type of signaling to be sent (**MF**, **DP**, **DTMF** or **RING**) from the **Dial/Ring** function. (RING will only appear in the menu if you have *Purchase Option 935AT-330 Ring Generator/True REN-3 Load* installed.)
2. Press the **Option Menu** function key.
3. Use the **Up/Down Arrow** keys to scroll through the option menus, **OR** select **1** using the **numeric keypad** and press the **Option Menu** function key. The display reads:



4. Press **ENT** or any softkey. The resulting **MODIFY** display will vary depending on whether you selected **MF** or **DTMF**, **DP**, or **Ring**. Each of these types are discussed below.

### 5-1.1 MF or DTMF Digits

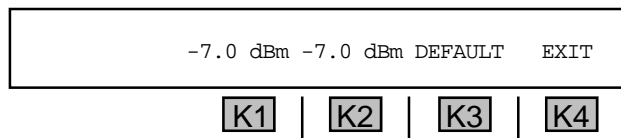
If you selected **MF** or **DTMF** mode under the **Dial/Ring** function key, the **MODIFY** display reads:



#### 5-1.1.1 Level

To change the **output level**:

1. Press **K1** under **LEVEL**. The display reads:



2. Press **K1** to change the low frequency tone level **OR** press **K2** to change the high frequency tone level.

## Section V Option Menu Numbers

---

3. Use the **numeric keypad** to change the level.

- A valid **LEVEL** in **MF** and **DTMF** is between **-99.9** and **+12.0**, and between **-99.0** and **+3.0** in **PCM**.

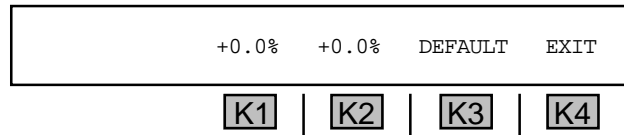
4. Press **K4** to exit to the **MODIFY** display.

### 5-1.1.2 Frequency

---

To change the **output frequency**:

1. Press **K2** under **FREQ**. The display reads:



2. Press **K1** to change the low tone percentage, or **K2** to change the high tone percentage.
3. Use the **numeric keypad** to enter a new tone percentage.

- A valid **tone percentage** is between **-99.9%** and **+99.9%**. (**+99.9%** effectively doubles the frequency. **+99.9%** halves the frequency.)

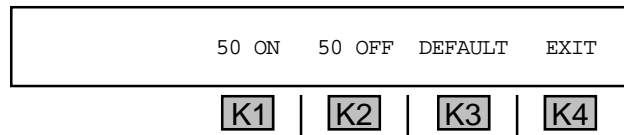
4. Press **K4** to exit to the **MODIFY** display.

### 5-1.1.3 Timing

---

To change the **timing interval**:

1. Press **K3** under **TIMING**. The display reads:



2. Press **K1** to change the **ON** time or **K2** to change the **OFF** time.
3. Use the **numeric keypad** to enter a new timing interval.

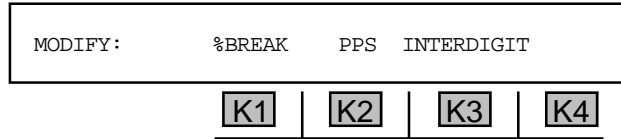
- A valid **timing** interval is between **10 ms** and **9999 ms**. In the **TIMING** display, In **MF**, the default is **70 ON 70 OFF**. In **DTMF**, the default is **50 ON 50 OFF**. If using a **KP**, the **935AT** automatically adds **30 ms** to its **ON** time.

4. Press **K4** to exit to the **MODIFY** display.



## 5-1.2 DP Digits

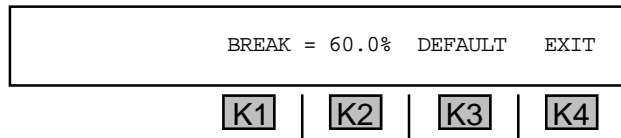
If you selected **DP** mode under the **Dial/Ring** function key, the **MODIFY** display reads:



### 5-1.2.1 % Break

To change the **% break**:

1. Press **K1** under **% BREAK**. The display reads:



2. Use the **numeric keypad** enter a new **% break**.

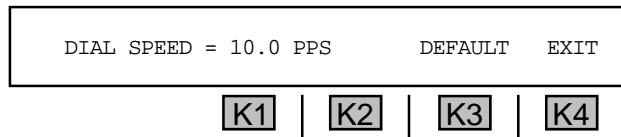
- A valid **%break** is between **25.0%** and **80.0%** with a default percentage of **60.0%**.

3. Press **K4** to exit to the **MODIFY** display.

### 5-1.2.2 Pulses Per Second

To change the **PPS**:

1. Press **K2** under **PPS**. The display reads:



2. Use the **numeric keypad** to enter a new interval.

- A valid **PPS** is between **2.0 PPS** and **35.0 PPS** with a default of **10.0 PPS**.

3. Press **K4** to exit to the **MODIFY** display.

## Section V Option Menu Numbers

---

### 5-1.2.3 Interdigit Time

---

To change the **time interval between digits**:

1. Press **K3** under **INTERDIGIT**. The display reads:

INTERDIGIT TIME = 700 ms	DEFAULT	EXIT	
<b>K1</b>	<b>K2</b>	<b>K3</b>	<b>K4</b>

2. Use the **numeric keypad** to enter a new interdigit time.

- A valid **interdigit range** is between **100 ms** and **990 ms** with a default of **700 ms**.

3. Press **K4** to exit to the **MODIFY** display.

### 5-1.3 Ring Generator

---

Option Menu #:  
1

For the ring generator (**RING**) to be valid, *Purchase Option 935AT-330, Ring Generator/True REN-3 Load* must be installed and the **935AT** must be supplying **BATTERY** in an analog trunk type and in **TERMINATE** mode. (In PCM, the **935AT** does not supply the ringing voltage, but provides a PCM ring signal state)

If you selected **BATTERY** under the **Trunk Type** function key and **RING** under the **Dial/Ring** function key, the **MODIFY** display reads:

MODIFY:	LEVEL	FREQ	TIMING
<b>K1</b>	<b>K2</b>	<b>K3</b>	<b>K4</b>

#### 5-1.3.1 Level

---

To change the **output level**:

1. Press **K1** under **LEVEL**. The display reads:

UNLOADED VOLTAGE	86 VRMS	DEFAULT	EXIT
<b>K1</b>	<b>K2</b>	<b>K3</b>	<b>K4</b>

2. Use the **numeric keypad** to enter a new level.

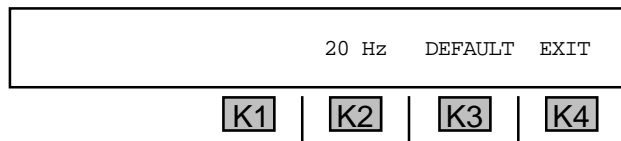
- A valid **LEVEL** is between **15 VRMS** and **99 VRMS** with a default of **86 VRMS**.

3. Press **K4** to exit to the **MODIFY** display.

### 5-1.3.2 Frequency

To change the output **frequency**:

1. Press **K2** under **FREQ**. The display reads:



2. Use the **numeric keypad** to enter a new frequency.

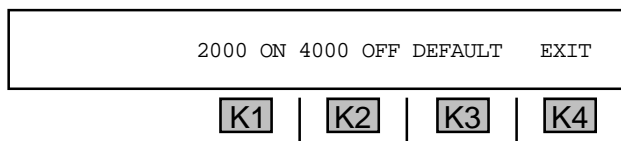
- A valid **frequency** is between 15 Hz and 65 Hz with a default of 20 Hz.

3. Press **K4** to exit to the **MODIFY** display.

### 5-1.3.3 Timing

To change the **timing interval**:

1. Press **K3** under **TIMING**. The display reads:



2. Press **K1** to change the **ON** time or **K2** to change the **OFF** time.

3. Use the **numeric keypad** to enter a new interval.

- A valid **timing interval** is between 150 ms and 9999 ms, with a default of 2000 ms for **ON** and 4000 ms for **OFF**.

4. Press **K4** to exit to the **MODIFY** display.

**Section V Option Menu Numbers**

---

**5-2 OPTION MENU #: 2 SEND DIGIT SEQUENCES**

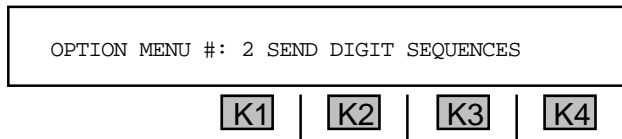
---

**OPTION MENU #: 2 SEND DIGIT SEQUENCES** is a standard feature that facilitates multistage outpulsing of stored phone numbers where one or more phone numbers are outpulsed in sequence, possibly separated by supervision or call progress events and terminated by a test line. This option operates with **OPTION MENU #: 1 MODIFY DIAL RING**, **OPTION MENU #: 3 REMOTE CONTROL**, **OPTION MENU #: 4 DIGIT RECEIVER**, **OPTION MENU #: 9 WINK TIMING**, **OPTION MENU #: 26 ROTL/RESPONDER**, and **OPTION MENU #: 29 CALL 102 LINE**.

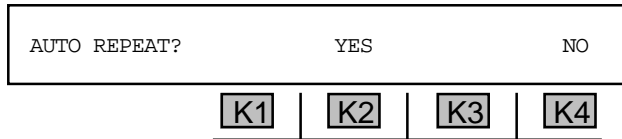
To send **digit sequences**:

1. Press the **Trunk Type** function key to set up a trunk. If you are testing between two **935ATs** in a 2W trunk type, you should set one end to **CONTACT** (usually the send unit), and one end to **BATTERY** (usually the receive unit, which is set up in **OPTION MENU #: 4 DIGIT RECEIVER**).
2. Use the **numeric keypad** to enter the telephone numbers you want to send one at a time under **Dial/Ring** function. (Refer to **Section 3 Front Panel Operation** for a description of the dial ring function.)
3. Use the **STO** key to store each of the numbers separately in the storage registers (**01 to 998**). (Refer to **Section 3-6.1** for a description of the **STO** key function.)
4. Press the **Option Menu** function key.
5. Use the **Up/Down Arrow** keys to scroll through the option menus, **OR** select **2** using the **numeric keypad** and press the **Option Menu** function key. The display reads:

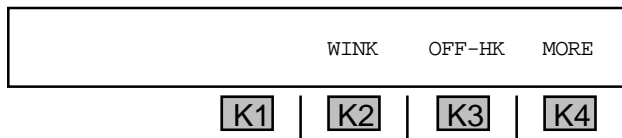
Option Menu #:  
2



6. Press **ENT** or any softkey (**K1-K4**). The display reads:



7. Press **K2** under **YES** if you wish the test to continuously repeat, **OR** press **K4** under **NO** to send the sequence only once. The display reads:



At the originating end, the **sequence** consists of the record storage location of the digits to be outpulsed, and the supervision events expected from the terminating end. The table below shows the most common call sequence types.

The supervision events are:

**WINK**-a single line signalling pulse. A **W** is added to the sequence at the originating end to wait for a wink. A wink must be less than **600 msec**s or the event will fail. (Refer to **Option Menu #9 Wink Timing**.)

**OFF-HOOK**-the condition where the receiver or handset is off the switch. An **H** is added to the sequence at the originating end to wait for an off-hook signal from the terminating end. An off-hook must be more than **200 msec**s in duration or the event will fail. (Refer to **Option Menu #9 Wink Timing**.)

**PAUSE**-a delay of one second before proceeding.

**D-DIAL** (Delay Dial)-A signalling event that responds to a request for service and indicates a start dial to the sending switch. A **D** is added to the sequence to tell the originating end to wait for the terminating end to return an

off-hook signal in response to the incoming request for service. The originating end then waits to receive an on-hook signal when the receiving end is prepared to receive the incoming digits. It is used on delay dial lines.

After the originating end sends a digit sequence and connects to the test line that will undergo testing, you should select a test line type. This can be a call progress, 102, 105, or 23 tone type test line.

**TESTLINE**- Tells the **935AT** to wait for an off-hook at the end of a call and expect a test line. Available test lines are:

**CPROG**- the answering end goes off-hook and sends call progress tones.

**102**-the answering end goes off-hook and sends **1004 Hz** at **-16 dBm**.

**105**-the answering end goes off hook and acts as a type 105 responder.

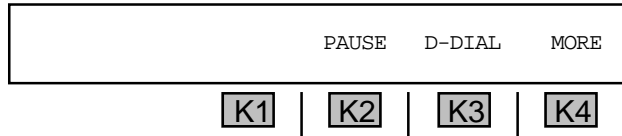
**23TONE**- the answering end goes off-hook and performs a 23 tone test.

Sequence Type	Typical Sequence
<b>Immediate Dial</b>	<b>1</b>
<b>Sequence Progress</b> Originating end goes off hook and sends digits in record location #1.	
<b>Wink Start</b>	<b>W1</b>
<b>Sequence Progress</b> 1. Originating end seizes the line. 2. Terminating end provides a wink ( <b>W</b> ). 3. Originating end sends digits in record location #1 after receiving the wink.	
<b>Ground Start</b>	<b>H1</b>
<b>Sequence Progress</b> 1. Originating end seizes the line. (provides ring ground) 2. Terminating end goes off hook. (provides tip ground) ( <b>H</b> ) 3. Originating end switches to loop and sends digits in record location # 1 after receiving the off hook signal.	
<b>TSPS</b>	<b>W1H2</b>
<b>Sequence Progress</b> 1. Originating office seizes the line. 2. Terminating office sends a wink. ( <b>W</b> ) 3. Originating office sends digits in record location # 1 after receiving the wink. 4. Terminating end stores received digits and goes off hook. ( <b>H</b> ) 5. Originating office sends second set of digits in record location #2 after receiving the off hook signal.	

Option Menu #: 2

## Section V Option Menu Numbers

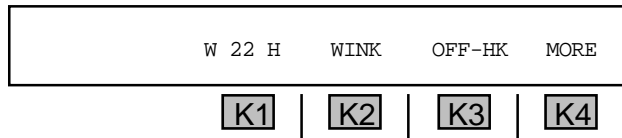
- Use the **numeric keypad** to enter the stored memory location of the numbers to be outpulsed. To tell the **935AT** to wait for a **WINK** (W) from the far-end, press **K2**, or tell the **935AT** to wait for an **OFF-HK** (H) by pressing **K3**.
- Press **K4** under **MORE**. The display reads:



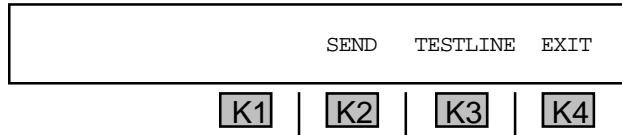
- Press **K2** to add a **PAUSE** (-) **OR** press **K3** to add a **D-DIAL** (D).

**for example:**

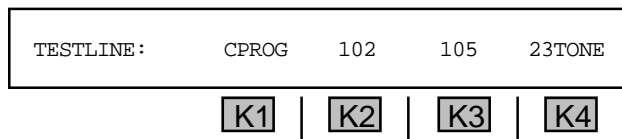
A sequence that includes a **WINK**, the number in stored memory location **22**, followed by an **OFF-HK** reads:



- Press **K4** under **MORE** again. The display reads:



- Press **K3** under **TESTLINE** to select the type of responder. The display reads:



- Press the softkey (**K1-K4**) below the desired responder. You will be returned to the previous display.
- Press **K2** under **SEND** to begin a sequence. This send function sends the sequence without going off-hook and is for use only when in a **DRY** trunk type or when supplying **BATTERY**.

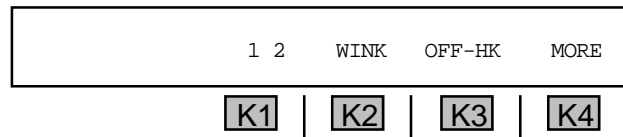
### 5-2.1 Sending a Call More Than 18 Digits Long

To send numbers to be outpulsed that are more than **18 digits** long, you must enter the numbers in **18** digit blocks (the maximum number allowed) from the storage register.

*for example:*

To send a string of 30 DTMF digits:

1. Select the **Dial/Ring** function key.
2. Press **K3** to select **DTMF** mode.
3. Use the **numeric keypad** to enter the first eighteen digits and store the string in **memory location 1**.
4. Clear out the display and enter the last twelve digits and store them in **memory location 2**.
5. Press the **Option Menu** function key.
6. Enter **OPTION MENU #: 2**.
7. Press **K2** under **YES** if you wish the test to continuously repeat, **OR** press **K4** under **NO** to send the sequence only once.
8. Use the **numeric keypad** to enter the number **1** and press **ENT**.
9. Enter the number **2** and press **ENT** again. The display reads:



10. Go **off-hook**. The numbers stored in the two registers will be automatically outpulsed as a single digit string with a pause between the two records (approx. 1 sec)

You can view the timing of wink, pre-wink and off-hook timing events in **Option Menu #: 9 Wink Timing**.

Option Menu #:  
2

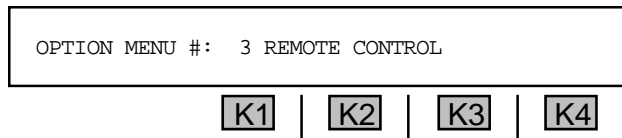
## Section V Option Menu Numbers

### 5-3 OPTION MENU #: 3 REMOTE CONTROL

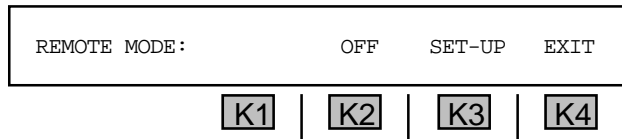
**OPTION MENU #: 3 REMOTE CONTROL** is a standard feature that allows you to set up the **935AT** for remote control operation.

To set up the **935AT** for remote control operation:

1. Press the **Option Menu** function key.
2. Use the **Up/Down Arrow** keys to scroll through the option menus, **OR** select **3** using the **numeric keypad** and press the **Option Menu** function key. The display reads:



3. Press **ENT** or any softkey (**K1-K4**) to activate your selection. The display reads:



4. Press **K2** to scroll through the different remote modes. The following modes are available:

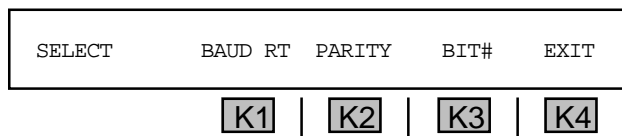
<b>OFF</b>	Places <b>935AT</b> under manual control (no remote control)
<b>TERMINAL</b>	Places <b>935AT</b> under dumb terminal control.
<b>COMPUTER</b>	Places <b>935AT</b> under computer control through the RS-232 serial port directly, or via a modem connection.
<b>PRINTER</b>	Used to drive a printer connected to the RS-232 serial port.
<b>MASTER, SLAVE, and ATR</b> are reserved for future use.	
(The remote modes are explained in detail in <b>Section 6, Remote Control Operation.</b> )	

5. Press **K1** to put the **935AT** into **STANDBY MODE**, which enables you to operate the **935AT** manually without losing remote access capability. The **935AT** will remain in **STANDBY MODE** until **K1** is pressed again.

#### 5-3.1 Setup

To set up the **935AT** for remote control operation:

Press **K3** under **SET-UP**. The display reads:



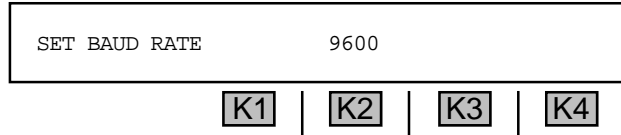


### 5-3.1.1 Baud Rate

**Baud rate** is the number of bits of data transmitted per second in a data signal.

To change the **baud rate**:

1. Press **K1** under **BAUD RATE**. The display reads:



2. Use the **numeric keypad** to enter a new baud rate.

- A valid baud rate is between **300** and **38400**. The default value is **9600 baud**.

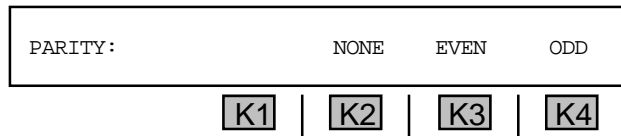
3. Press **ENT** or any softkey (**K1-K4**) to exit this display. You will be returned to the **SELECT** display.

### 5-3.1.2 Parity

**Parity** is a method of minimizing errors in data transmissions by adding an extra binary signal to each character to make the total number of 1s or 0s either odd or even for each character.

To change the **parity**:

1. Press **K2** under **PARITY** from the **SELECT** display. The new display reads:



2. Press **K2** under **OFF** for no parity, **K3** for **EVEN** parity **OR** press **K4** for **ODD** parity. The default is **EVEN**. You will be returned to the **SELECT** display after you make your selection.

### 5-3.1.3 Bit Number

The **bit number** is the number of bits that make up a character. 7 bits are used to produce standard ASCII characters.

**Stop bits** are the bit or bits following character code in start stop transmissions.

To change the **data format**:

1. Press **K3** under **BIT#** from the **SELECT** display.

## Section V Option Menu Numbers

---

The new display reads:

BITS PER CHARACTER:	7	8
<input type="checkbox"/>	<input type="checkbox"/>	<input type="checkbox"/>

K1 |  K2 |  K3 |  K4

2. Press **K2** to select **7** bits **OR** **K4** to select **8** bits. (The default format is **7** bits per character). The display reads:

STOP BITS:	1	1-1/2	2
<input type="checkbox"/>	<input type="checkbox"/>	<input type="checkbox"/>	<input type="checkbox"/>

K1 |  K2 |  K3 |  K4

3. Press **K2** to select **1** stop bit, **K3** to select **1-1/2** stop bits **OR** press **K4** to select **2** stop bits. The default stop bit value is **1**. You will be returned to the **REMOTE MODE** display.

### 5-3.2 Terminal Selection and Reporting

---

To select a **terminal type** (if in terminal mode) **OR** **reporting format** (if in computer or printer mode):

1. Press **K4** under **EXIT** from the **REMOTE MODE** display.

If you selected **TERMINAL** mode, the display reads:

TERMINAL TYPE:	TVI-920	VT-100
<input type="checkbox"/>	<input type="checkbox"/>	<input type="checkbox"/>

K1 |  K2 |  K3 |  K4

Pressing **K2** will enable you to connect the **935AT** to a **TVI-920** type terminal, and pressing **K4** will enable you to connect to a **VT-100** terminal. You will be returned to the **REMOTE MODE** display after making your selection.

If you selected **COMPUTER** or **PRINTER** mode, you will enter a sequence of report setup displays identical to the ones in **OPTION MENU #: 34 SELECT REPORTS:**

REPORT ERRORS?	YES	NO
<input type="checkbox"/>	<input type="checkbox"/>	<input type="checkbox"/>

K1 |  K2 |  K3 |  K4

If in **PRINTER** remote mode, the display reads: **PRINT ERRORS?**

- Press **K3** under **YES** to send the **PCM** formatted error report **OR** press **K4** under **NO** to omit the **PCM** formatted error report. The display reads:

REPORT RECEIVED RECORDS?	YES	NO	
<b>K1</b>	<b>K2</b>	<b>K3</b>	<b>K4</b>

If in **PRINTER** remote mode, the display reads: **PRINT RECEIVED RECORDS?**

- Press **K3** under **YES** to send calls captured by the digit receiver **OR** press **K4** under **NO** to omit the calls captured by the digit receiver. Selecting **YES** displays the following display. Selecting **NO** skips the following display.

REPORT DIGIT ANALYSIS?	YES	NO	
<b>K1</b>	<b>K2</b>	<b>K3</b>	<b>K4</b>

If in **PRINTER** remote mode, the display reads: **PRINT DIGIT ANALYSIS?**

- Press **K3** under **YES** to send the analysis of the received digits **OR** press **K4** under **NO** to omit the analysis of the received digits. The display reads:

REPORT WINK TIMING?	YES	NO	
<b>K1</b>	<b>K2</b>	<b>K3</b>	<b>K4</b>

If in **PRINTER** remote mode, the display reads: **PRINT WINK TIMING?**

- Press **K3** under **YES** to send the report on wink timing measurements **OR** press **K4** under **NO** To omit wink timing measurements. The display reads:

READY			
<b>K1</b>	<b>K2</b>	<b>K3</b>	<b>K4</b>

A prompt will be sent to the host computer to indicate that the **935AT**'s command buffer is empty and the **935AT** is awaiting instructions.

- Press the **Option Menu** function key to exit.

## Section V Option Menu Numbers

---

### 5-4 OPTION MENU #: 4 DIGIT RECEIVER

---

**OPTION MENU #: 4 Digit Receiver** is a standard feature. In **TERM** (terminate) mode, the **935AT** can completely emulate terminating equipment. It can receive and record one or more phone numbers (in **MF**, **DTMF**, or **DP** format), possibly separated by supervision or call progress events and terminated by a testline. The outpulsing sequence is broken into groups of digits and supervision events called **records**.

In **BRIDGE** mode on analog trunks, or the **MON-1** or **MON-1&2** modes on **PCM** trunks the digit receiver option can be used to monitor the interaction between equipment. In **BRIDGE** or **MON-1&2** modes, the receive unit looks for, and times, supervision events (Winks, off-hooks, etc.)

This option is used in conjunction with **OPTION MENU #: 1 MODIFY DIAL RING**, **OPTION MENU #: 2 SEND DIGIT SEQUENCES**, **OPTION MENU #: 3 REMOTE CONTROL**, **OPTION MENU #: 9 WINK TIMING**, **OPTION MENU #: 26 ROTL/RESPONDER**, and **OPTION MENU #: 29 CALL 102 LINE**.

To use the **digit receiver**:

1. Press the **Trunk Type** function key to set up a trunk. If you are testing between two **935ATs** in a 2W trunk type, you should set one end to **CONTACT** (usually the send unit), and one end to **BATTERY** (usually the receive unit).
2. Press the **Option Menu** function key.
3. Press the **Up/Down Arrow** keys to scroll through the option menus, **OR** select **4** using the **numeric keypad** and press the **Option Menu** function key. The display reads:

OPTION MENU #: 4 DIGIT RECEIVER

K1 | K2 | K3 | K4

4. Press **ENT** or any softkey (**K1-K4**) to enter the **SETUP** display. The display reads:

SET-UP RECEIVE ANALYZE EXIT

K1 | K2 | K3 | K4

#### 5-4.1 Setup

---

To set up a **sequence to be received**:

Press **K1** under **SET-UP**. The display reads:

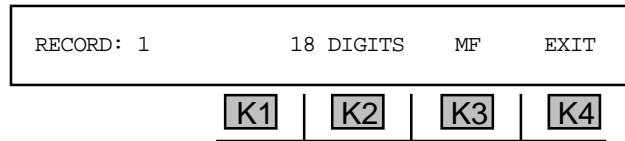
SET RECEIVE: PARAMETERS SEQUENCE EXIT

K1 | K2 | K3 | K4

### 5-4.1.1 Parameters

To set the **parameters**:

1. Press **K1** under **PARAMETERS**. The display reads:



2. Press **K3** to select the signalling type. The display cycles between **MF** (Multi-Frequency) **DTMF** (Touchtone®), or **DP** (Dial Pulse).
3. Use the **numeric keypad** to enter the length of the number to be received (from **1** to **18** digits in length). The **935AT** treats each incoming set of digits as a **RECORD**.

**Note:** If a call is **MF**, you do not need to tell the **935AT** the length of each number because it recognizes the **KP** and **ST**.

4. Use the **Up/Down Arrow** keys to scroll through records 1-4.
5. Press **K4** under **EXIT** to return to the main setup display.

### 5-4.1.2 Sequence

At the **terminating end**, the **sequence** consists of the record storage location in which the **935AT** will store digits received from the originating end, and the supervision events sent from the terminating end to the originating end.

The table on the right shows the progress of the four most common sequence types and the sequence that should be entered into the **935AT** at the terminating end to set it up to receive digits from the originating end.

Sequence Type	Typical Sequence
<b>Immediate Dial</b>	<b>1</b>
<u>Sequence Progress</u> 1. Originating end goes off hook and sends digits. 2. Terminating end stores received digits in record (1).	
<b>Wink Start</b>	<b>W1</b>
<u>Sequence Progress</u> 1. Originating end seizes the line. 2. Terminating end provides a wink ( <b>W</b> ). 3. Originating end sends digits. 4. Terminating end stores received digits in record (1).	
<b>Ground Start</b>	<b>H1</b>
<u>Sequence Progress</u> 1. Originating end seizes the line. (provides ring ground) 2. Terminating end goes off hook. (provides tip ground) ( <b>H</b> ) 3. Originating end switches to loop and sends digits. 4. Terminating end stores received digits in record (1).	
<b>TSPS</b>	<b>W1H2</b>
<u>Sequence Progress</u> 1. Originating office seizes the line. 2. Terminating office sends a wink. ( <b>W</b> ) 3. Originating office sends digits. 4. Terminating end stores received digits in record (1). 5. Terminating end goes off hook. ( <b>H</b> ) 6. Originating office sends second set of digits. 7. Terminating end stores received digits in record (2).	

Option Menu #: 4

## Section V Option Menu Numbers

You can add line signalling events to your sequence as well as digit records. The **935AT** can send them in terminated mode or recognize them in bridge mode (Mon 1&2 in PCM). These events are:

**WINK**-a single line signalling pulse. A **w** is added to the sequence at the receiving end to send a wink when it is ready to receive a digit record from the originating end. A wink must be less than **600 msec**s or the event will fail. (Refer to **Option Menu #9 Wink Timing**.)

**OFF-HOOK**-the condition where the receiver or handset is off the switch. An **H** is added to the sequence at the receiving end to send an off-hook signal to the originating end. An off-hook must be less than **200 msec**s in duration or the event will fail. (Refer to **Option Menu #9 Wink Timing**.)

**PAUSE**-a pause of one second before proceeding. Use this when terminating a call, never when monitoring. A **PAUSE** appears as a - in the sequence.

**D-DIAL**- a signalling event that tells the terminating end to go on-hook when ready to receive digits. It is used for delay dial lines, and appears in the sequence as a **D**.

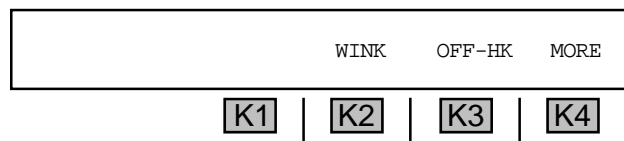
**TESTLINE**- Tells the **935AT** to go off-hook at the end of a call and simulate a test line. Testline setup is available only when in Terminate mode or D&I in PCM. The test lines are:

- 100- the **935AT** goes off-hook and provides quiet termination.
- 102-the **935AT** goes off-hook and sends 1004 Hz at -16 dBm.
- 105-the **935AT** goes off hook and acts as a type 105 responder.
- LOOPBACK**- the **935AT** goes off-hook and acts as a loopback testline.

Option Menu #:  
4

To set the **sequence**:

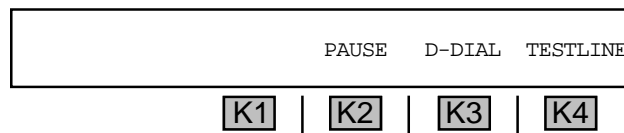
1. Press **K3** under **SEQUENCE** from the **SET RECEIVE** display. The new display reads:



2. Press **K2** under **WINK** to add a **w** (wink) to your sequence (for a Wink Start trunk), **OR** press **K3** under **OFF-HK** to add an **H** (off-hook) (for a Ground Start trunk in **TERM** mode. )

For Immediate Start trunks or Ground Start trunks not in **TERM** mode, a wink or off-hook is not necessary.

3. Use the **numeric keypad** to enter the number of the registers, 1-4, where you want to store the incoming records.
4. If you expect to see or give answer supervision, press **K3** under **OFF-HK**.
5. Press **K4** under **MORE**. The display reads:



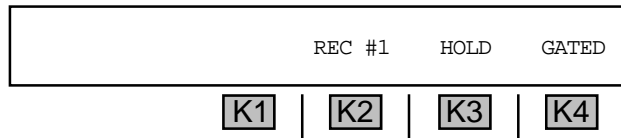
6. Press **K2** to add a - (one-second pause) to your sequence, **K3** to add a D (dial delay), **OR** press **K4** to select a testline.
7. Press the **Option Menu** function key to return to the main **SET RECEIVE** display, **OR** press **K4** under **EXIT** to back out another step to the main selection display.

### 5-4.2 Receive

To activate the **digit receiver**:

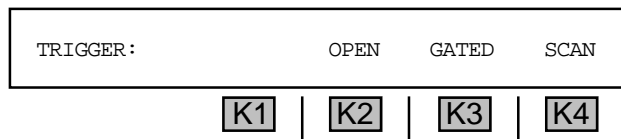
1. Press **K2** under **RECEIVE** from the **SETUP** display.

*for example:*



When the trunk is seized and digits are sent, the digits will appear on the left side of the display.

2. Press **K2** under **REC #1** to scroll through the available records.
3. Press **K3** to toggle **HOLD** on/off. In the on position. The captured digits are held until **K3** is pressed a second time. The factory default is **OFF**.
4. Press **K4** under **GATED** to select a trigger. The display reads:



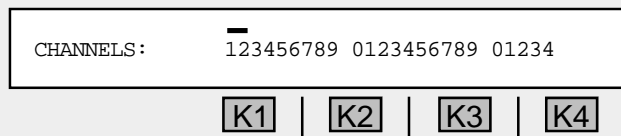
5. Press **K2** to activate **OPEN** mode, press **K3** to activate **GATED** mode **OR** press **K4** under **SCAN** (when in **PCM** mode only) to scan all **24 PCM channels**.

**OPEN** mode will receive digits regardless of the supervision state. The **935AT** will go to **HOLD** after the records are received.

**GATED** mode waits for an on-to-off-hook transition before the digit receiver is activated.

**SCAN** mode scans all **24 PCM channels** until it sees one channel go off-hook and will collect digits from that channel. The **935AT** will continue monitoring the active channel until it goes back on-hook, or until the requested digit records are full. It automatically scans the next call until **K4** is pressed again, discontinuing the function.

If you select **SCAN**, the display reads:



## Section V Option Menu Numbers

---

Use the **numeric keypad** to enter each channel to be scanned (the display will briefly read **ENTER CHANNEL #:**) and press **ENT**.

- A valid number of **channels to be scanned** is between **1** and **24**.

**Note:** If you enter the number of a channel that has already been selected, that channel will then be deselected.

Alternately, you can press **K1** to select **ALL** channels or the **CLR** key to clear all channels. You can then use the **Left/Right Arrow** keys to place the cursor over a channel to be added/or deleted, then change it using the **numeric keypad**.

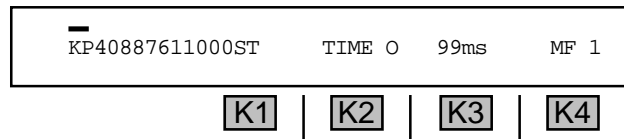
6. Press the **Option Menu** function key to return to the main display once the digits have been received.

### 5-4.3 Analyze

---

To **analyze** the characteristics of each digit in the received string:

1. Press **K3** under **ANALYZE** from the **MAIN** display. A sample display appears below:



An **MF** record has been received. The cursor is over the first digit, in this case, **KP**.

2. Use the **Left/Right Arrow** keys to move the cursor from one digit to the next.
3. Press **K2** to scroll through the amplitudes and frequencies of the two tones which make up the **KP** as well as their **ON** and **OFF** times.
4. Press **K4** to scroll through each record if multiple records have been stored.
5. Press the **Option Menu** function key to back out of the **ANALYZE** display to the main display. (Refer to **Section 6, Remote Control Operation** for sending results to a computer or printer.)



5-5 OPTION MENU #: 5 RING LOAD

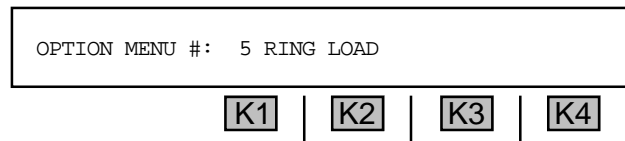
**OPTION MENU #: 5 RING LOAD** is available only when *Purchase Option 935AT-330, Ring Generator/ True REN-3 Load* is installed. This feature provides a true Ringer Equivalent Number 3 (**REN-3**) load to terminate ringing supplies. The Ring Generator is intended for operation on 2- and 4-wire Loop and Ground Start trunks.

**WARNING!** *The ring generator can produce potentially dangerous voltage levels. DO NOT touch the test leads while the generator is operating.*

5-5.1 Setup

To set up the ring load generator:

1. Set the **935AT** to **CONTACT** mode in the Trunk Type setup. (Refer to **Section 3-2.1, Trunk Type Function Key** for trunk type setup.)
2. Press the **Option Menu** function key.
3. Use the **Up/Down Arrow** keys to scroll through the option menus **OR** select **5** using the **numeric keypad** and press the **Option Menu** function key. The display reads:

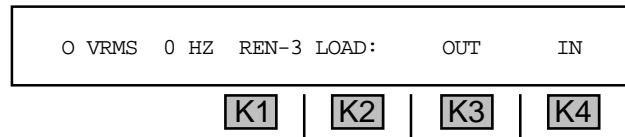


4. Press **ENT** or any softkey (**K1-K4**) to activate your selection.

If you are in **BATTERY**, the display reads: **NOT APPLICABLE**.

If you are in **4W LOOP** or **4W GROUND START**, there is no display of the ring level and frequency.

If you are in **2W LOOP** or **2W GROUND START**, the display reads:



5. Press **K3** under **OUT** to place the **REN-3** Load off-line (as shown above), **OR** press **K4** under **IN** to have the **935AT** act as a true **REN-3** Load at its **TR** or **T1R1** jacks.
6. Toggle the **hookswitch** to the **On Hook** position. When ringing is introduced on a 2-wire trunk, the display will show the voltage level in RMS volts (**VRMS**) and the frequency in Hertz (**Hz**).
7. Toggle the **hookswitch** to the **Off Hook** position to trip ringing.
8. Press **K2** or **K3** to move the cursor back to **OUT**.

Option Menu #: 5

## Section V Option Menu Numbers

---

### 5-6 OPTION MENU #: 6 DC VOLT/AMP METER

---

**OPTION MENU #: 6 DC VOLT/AMP METER** is a standard feature that provides DC voltage and current measuring capability on metallic (analog) trunks. It allows you to:

- determine the levels of supervision voltages and applying the information towards setting thresholds in **OPTION MENU #: 7 SUPERVISION THRESHOLDS**.
- measure the DC voltage from Tip-to-Ground, Ring-to-Ground, and Ring-to-Tip on 2-wire Loop and 2-wire Ground-Start trunks.
- measure the DC voltage from TR-to-Ground, T1R1-to-Ground and TR-to-T1R1 on 4-wire Loop and 4-wire Ground-Start trunks.
- measure the DC voltage from E-to-Ground and M-to-Ground on E&M trunks. All voltage readings are printed as signed values to the nearest volt. This feature may be used in either **TERM** or **BRIDGE** mode.
- measure the loop current to its own closed contact of a loop start trunk.

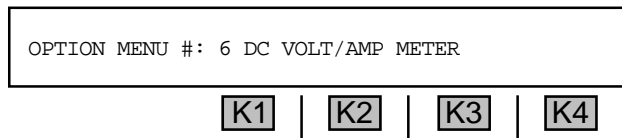
#### 5-6.1 Loop and Ground Start Measurements

---

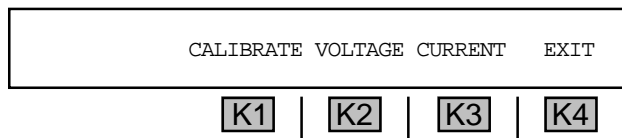
Option Menu #:  
6

To enter the **loop and ground loop measurements** function:

1. Press the **Option Menu** function key.
2. Use the **Up/Down Arrow** keys to scroll through the option menus, **OR** select **6** using the **numeric keypad** and press the **Option Menu** key. The display reads:



3. Press **ENT** or any softkey (**K1-K4**) to activate your selection. The display reads:



##### 5-6.1.1 Calibrate

---

To **calibrate** the **935AT** prior to testing:

1. Press **K1** under **CALIBRATE** to force the **935AT** calibrate itself prior to making a measurement. You will see the message: **PLEASE UNPLUG CABLES FOR CALIBRATION**. This message will change to: **PRESS ANY SOFT KEY TO CALIBRATE**.

2. Remove any cables connected to the **935AT** front panel.
3. Press any softkey (**K1-K4**) to continue.

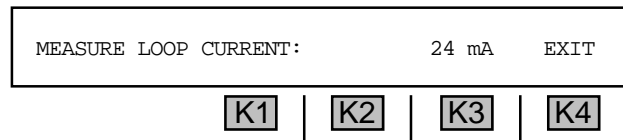
If calibration is not successful, the display reads: **CAL FAILED -- CHECK FOR VOLTAGE ON LINE.**

### 5-6.1.2 Current

To measure the **office battery current** (available only in the contact end of a normal loop trunk:

1. Calibrate the **935AT**.
2. Plug the test cords back in.
3. Toggle the **hookswitch** to the **OFF HOOK** position.
4. Press **K3** under **CURRENT** in the main display. The loop current measurement is displayed.

*for example:*



Error messages are provided if you try to measure a parameter with an incorrectly setup trunk.

5. Press **K4** under **EXIT** to return to the main **SETUP** display.

### 5-6.1.3 Voltage

To measure **DC office battery voltage** or **935AT voltage**:

1. Press **K2** under **VOLTAGE** from the main **SETUP** display. A new display measuring Tip-to-Ground (**TIP TO GND**) appears.
2. Press **K1** to cycle between Tip-to-Ground (**TIP TO GND**), Ring-to-Ground (**RING TO GND**) and Tip-to-Ring (**TIP TO RING**) under on- and off-hook states.

The following table lists the range and accuracy of the various 2-wire and 4-wire DC Voltage measurements the **935AT** can make:

	<u>RANGE</u>	<u>ACCURACY</u>
Tip-to-Ring and TR-to-T1R1:	+60.0 to -60.0	+/- 3 volt
Tip-to-Ground and Ring-to-Ground:	+0.0 to -60.0	+/- 3 volt
TR-to-Ground and T1R1-to-Ground:	+0.0 to -60.0	+/- 3 volt

## Section V Option Menu Numbers

---

### **Ring to Tip**

A typical ring to tip measurement when On-Hook might be **-48V DC**. If the contact side goes off-hook, a lower reading (less than **-45V DC**) will be expected as current is drawn through the loop and voltage drops occur.

### **Tip-to-Ground**

In the Tip-to-Ground voltage measurement, an idle state (both sides on-hook) should give a **0V DC** measurement. This is the proper indication for a Loop Start trunk in the idle state.

When the battery side goes off-hook, a typical measurement of Tip-to-Ground voltage would be **-48V DC**. This indicates a battery reversal. Unless these or similar readings were obtained, there would be an indication of trouble in the loop supervision circuitry.

3. Press **K4** under **EXIT** to return to the main display.

## 5-6.2 E&M Measurements

---

To conduct **E&M measurements**:

1. Select **E&M** in the Trunk Type setup. (Refer to **Section 3-2.1, Trunk Type Function Key** for setup.)
2. Calibrate the **935AT** (Refer to **Section 5-6.1.1, Calibrate.**)
3. Conduct a voltage test. (Refer to **Section 5-6.1.3, Current**)

The following table shows the range and accuracy of the E&M 2-wire and 4-wire DC voltage measurements:

	<b><u>RANGE</u></b>	<b><u>ACCURACY</u></b>
M-to-Ground and E-to-Ground:	+0.0 to -100.0	+/- 3 volt

## 5-7 OPTION MENU #: 7 SUPERVISION THRESHOLDS

**OPTION MENU #: 7 SUPERVISION THRESHOLDS** is a standard function that allows you to set the supervision thresholds for the off-hook/on-hook LEDs. If expected voltages are not present and the supervision LEDs flicker or do not light, the threshold needs to be changed.

You cannot change the level of the supervision voltage which the **935AT** supplies as an output. This is fixed at **48 V** and **ground**. Voltage levels are printed as absolute values: **< 45V** does not mean “more negative” than **-45V**. It means less than **45 V** of potential. Values can be set to the nearest volt with an accuracy of **+/- 0.5 V**. Use **OPTION MENU #: 6 DC VOLT/AMP METER** to examine the current and voltage levels.

### Supervision Threshold Ranges for 48V DC

#### Normal Loop Start Supervision

Voltages above **39 V** will cause an **On Hook** indication from the supervision lamps. Voltages above **3 V** and below **39 V** will cause an **Off Hook** indication. A reversal of **-48 V** and ground would indicate the battery side is **Off Hook**. (Refer to **Section 5-7.2** for detailed setup information.)

#### Ground Start Supervision

Voltages on Ring above **33 V** indicate **On Hook** at the contact side. Voltages on Tip in excess of **33 V** indicate **On Hook** on the battery side.

#### E&M Supervision

*Originating End (SEND-M) Indications.*

The **ORIG LED** shows the status of the 'M' lead. An **Off Hook** indication is provided if the voltage is above **39 volts**. The LEDs will not be lit for voltages above **11 V** but below **39 V**. The LEDs indicate **On Hook** if the voltage is less than **11 V**. (Refer to **Section 5-7.3** for detailed setup information.)

The **TERM LEDs** show the status of the 'E' lead. An **Off Hook** indication is provided if the voltage is below **11 V**. The LEDs will not be lit for voltages above **11 V** but below **39 V**. The LEDs show an **On Hook** if the voltage is above **39 V**. (Refer to **Section 5-7.3** for detailed setup information.)

*Terminating End (SEND-E) Indications.*

In this case, the **ORIG LED** shows the status of the 'E' lead. The LEDs will indicate an **Off Hook** status if the voltage is below **11 V** and **On Hook** if the voltage is above **39 V**. The LEDs will not be lit for voltages above **11 V** but below **39 V**. (Refer to **Section 5-7.3** for detailed setup information.)

The **TERM LEDs** show the status of the 'M' lead. The LEDs will indicate an **Off Hook** status if the voltage is above **39 V** and **On Hook** if the voltage is less than **11 V**. The LEDs will not be lit for voltages above **11 V** but below **39 V**. (Refer to **Section 5-7.3** for detailed setup information.)

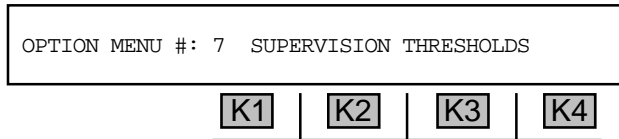
The following sections provide examples for setting Loop Start and E&M trunk supervision thresholds to accommodate **24 V** supervision instead of the normal **48 V**.

## Section V Option Menu Numbers

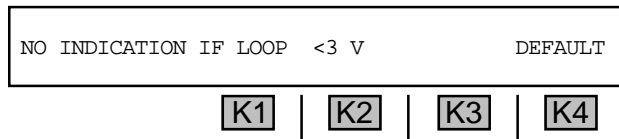
### 5-7.1 Loop Supervision Thresholds Other Than 48V DC

To set the **loop supervision threshold**:

1. Set the **935AT** to **NORMAL LOOP CONTACT 2W 600** or **900** under the **Trunk Type** function key. (Refer to **Section 3-2.1, Trunk Type Function Key** for setup information.)
2. Press the **Up/Down Arrow** keys to scroll through the option menus, or select **7** using the **numeric keypad**. The display reads:

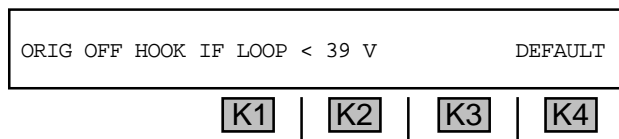


3. Press **ENT** or any softkey (**K1-K4**) to activate your selection. The display reads:



The display above shows that if there is no talk battery present (“dry” loop), there will be no voltage across the loop, and the **935AT** will turn off all supervision **LEDs**. This threshold is preset at **3 V**. For this example, this value will be adequate.

4. Press **K1**, **K2**, or **K3** to advance the display to the next choice. The display reads:



When the originate, or **CONTACT**, side of the circuit goes off-hook, it closes the loop between **Tip and Ring** (2-wire) or **TR** and **T1R1** (4-wire). This lowers the voltage difference across the loop. On a short loop, or near the contact end of the circuit, this voltage will be very small. Near the battery (Central Office) end on a long loop, this voltage can remain fairly large. The **935AT** sees the **Contact** end as being off-hook when the voltage across the loop falls below **39 V**. If a PBX is being tested and it is powered from **-24 V** instead of **-48 V**, the threshold of the **935AT** should be set to about **20V**.

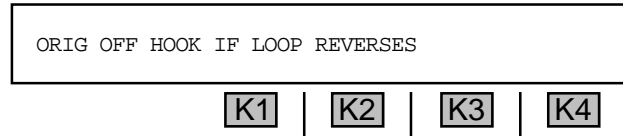
*for example:*

To set the **threshold** to **20 volts**:

1. Use the **numeric keypad** to enter the number **20**.
2. Press the **ENT** key. This value will now be remembered by the **935AT**.

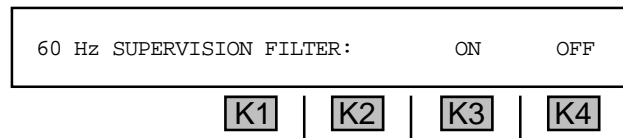
- Press **K4** under **DEFAULT** when you have finished testing or the readings will be incorrect when you go back to normal **48 V** trunks. The default value is **39 V**.

If you set the trunk type to simulate the Central Office, or **Battery** end of the circuit, the display below appears as a reminder:



The display above shows the **935AT** expecting the battery (Central Office) side of a loop start circuit to provide **-48 V** on **Ring** (2-wire) or **T1R1** (4-wire) in **Normal** mode. In **Loop Reverse**, the **935AT** expects to see **-48V DC** on **Tip** (2-wire) or **TR** (4-wire). It interprets this as the normal on-hook condition. A reversal from **-** to **+** is interpreted as the battery side of the circuit being off-hook. There is no voltage threshold.

- Press **K1**, **K2**, or **K3**. The **935AT** asks you to turn the **60 Hz** filter on or off:



- If you are receiving Dial Pulse digits, press **K4** to turn this filter **OFF**. Otherwise, press **K3**.
- Press the **Option Menu** function key to exit from this display.

Option Menu #: 7

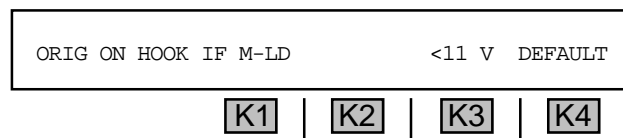
### 5-7.2 24V DC: E&M Supervision Thresholds

The various **E&M Types** (1 through 5) have different means of providing supervision battery to the **'E'** and **'M'** leads, but the end result is the same. In one supervision state the lead is held at **-48 V**. In the other state it is held close to ground. The intermediate voltages are interpreted as “no indication” and the **935AT** turns off the appropriate **LEDs**.

*for example:*

The **935AT** is assumed to be set to **E&M I SEND-M 4W** operation with a **24 V** supervised trunk instead of the normal **48 V**.

- Enter **OPTION MENU #: 7**. The display reads:

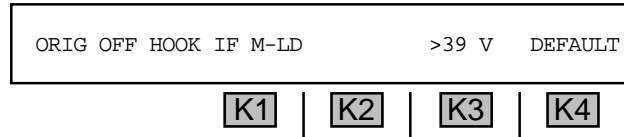


Since **24 V** is half of **48 V**, a good guess is to reduce everything displayed by half.

## Section V Option Menu Numbers

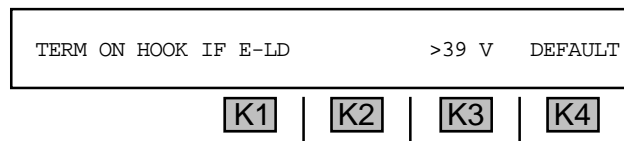
---

2. Use the **numeric keypad** to enter **6** (which is roughly half of **11**) and press **ENT**.
3. Press **K1**, **K2**, or **K3**. The display reads:



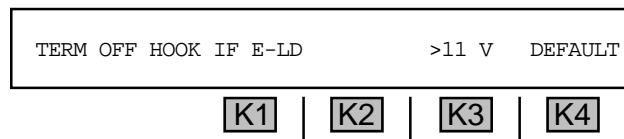
In this case the **935AT** will provide an **Off Hook** indication on the **ORIG LEDs** if the voltage on the **'M'** lead exceeds the **39 V** threshold. This value has to be changed to **20 V** (roughly half of 39).

4. Enter **20** from the **numeric keypad** and press **ENT**.
5. Press **K1**, **K2**, or **K3**. The display reads:



The **935AT** will provide no supervision indication if the voltage on the **'E'** lead is below the high threshold of **39 V** but above the low threshold of **11 V**. The high threshold can be changed to **20 V** as before.

6. Press **K1**, **K2**, or **K3**. The display reads:



An **Off Hook** indication on the front panel LEDs will be provided if the voltage on the **'E'** lead is below the **11 V** low threshold.

7. Change the voltage to **6 V** (roughly half of **11**).
8. Press the **Option Menu** function key to exit when the thresholds have all been set.
9. Return to each of the displays after you are finished testing and reset them to their default values to avoid problems on normal circuits.



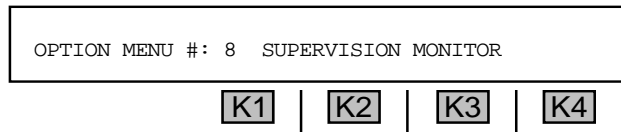
5-8 OPTION MENU #: 8 SUPERVISION MONITOR

**OPTION MENU #: 8 SUPERVISION MONITOR** is a standard function that gives the **935AT** the equivalent of a “strip chart recorder” feature for timing events of long duration, as well as for timing supervision events such as Guard times, Ground Start timing and other events not covered by **OPTION MENU #: 9 WINK TIMING** (Refer to Section 5-9, **Wink Timing** for more information).

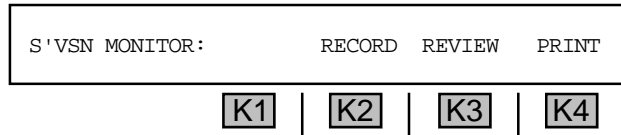
This option works on analog trunks as well as **PCM** trunks with the **935AT** terminating or monitoring the circuit (**BRIDGE** mode on analog trunks and **MONITOR** mode on **PCM**).

To **time events** of long duration or supervision events:

1. Press the **Option Menu** function key.
2. Use the **Up/Down Arrow** keys to scroll through the option menus, **OR** select **8** using the **numeric keypad** and press the **Option Menu** function key. The display reads:



3. Press **ENT** or any softkey (**K1-K4**) to activate your selection. The display reads:



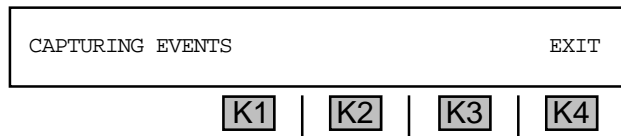
Option Menu #: 8

5-8.1 Analog Connections

5-8.1.1 Record

To **record events** in a time line format:

1. Press **K2** under **RECORD** and the **935AT** will record supervision events such as on-hooks and off-hooks as displayed by the LEDs which have been defined by **OPTION MENU #7: SUPERVISION THRESHOLDS** or **PCM** defined supervision. The display reads:



2. When enough data has been obtained, press **K4** under **EXIT** to stop collecting data and return to the **S'VSN MONITOR** display.

## Section V Option Menu Numbers

---

### 5-8.1.2 Analog: Review

---

To review events captured in **Record** mode:

1. Press **K3** under **REVIEW**. The display of the events varies according to the trunk type the **935AT** is setup to emulate. The display follows the front panel supervision **LEDs**. Lowercase 'o' and 't' indicate both the **ORIG** (Originating) and **TERM** (Terminating) sides of the circuit are **On Hook**. If uppercase 'O' and 'T' are displayed, both **ORIG** and **TERM** are **Off Hook**. The time is displayed as **MINUTES : SECONDS .MILLISECONDS** up to **255:59.999**.

*for example:*

Suppose the **935AT** had been capturing events for a period of time. After stopping the data collection as previously described, the first displayed result is:

EVENT # 0:    ORIG = o TERM = t    TIME: 0:00.00				
<table border="1"><tr><td>K1</td><td>K2</td><td>K3</td><td>K4</td></tr></table>	K1	K2	K3	K4
K1	K2	K3	K4	

2. Use the **Up/Down Arrow** keys or any softkey (**K1-K4**) to scroll through the list of the results. When you have reached the end of the results, the softkeys and **Up Arrow** key will become inactive. Pressing the **Left Arrow** key will return you to **EVENT #0** and pressing the **Right Arrow** key will advance to the maximum recorded **EVENT #**, skipping all interim events.

*for example:*

EVENT # 1:    ORIG = O TERM = t TIME: 0:00.406				
<table border="1"><tr><td>K1</td><td>K2</td><td>K3</td><td>K4</td></tr></table>	K1	K2	K3	K4
K1	K2	K3	K4	

Here the **ORIG** end is off-hook (uppercase **O**) after **406 milliseconds** and the **TERM** side is on-hook (lowercase 't').

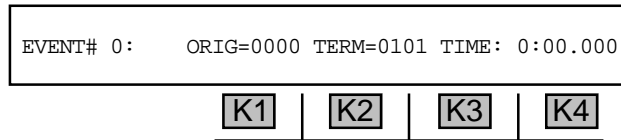
The display of **EVENT # 2:** might read:

EVENT # 2:    ORIG = O TERM = T TIME: 0:01.636				
<table border="1"><tr><td>K1</td><td>K2</td><td>K3</td><td>K4</td></tr></table>	K1	K2	K3	K4
K1	K2	K3	K4	

Here, the **TERM** end has gone off-hook (uppercase 'T') after **1.636 seconds**. The **935AT** can time up to **200 events** for up to **4 hours** unless a printer is connected. In this case the **935AT** continuously dumps its buffer when full and records continuously.

If the supervision on the line enters an undefined state (neither on-hook nor off-hook), the **935AT** will display it as undefined by showing a dash (–) instead of an upper or lower case character.

An undefined state is shown below:



Only supervision events are shown. Tones, digits and speech are not captured.

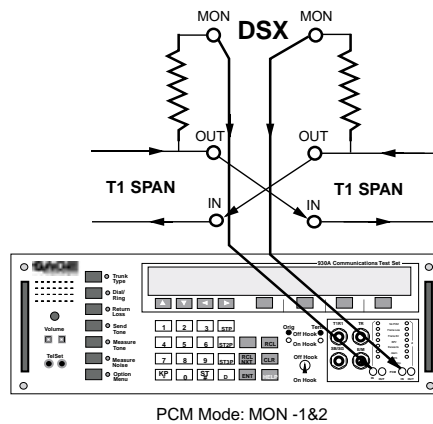
## 5-8.2 PCM Connections

### 5-8.2.1 Measuring ABCD Bit Timing

The 935AT gives you the capability to measure **ABCD bits** down to **7 millisecond** accuracy.

To use the **ABCD bit** timing function in **PCM** mode:

1. Connect the test cords as shown in **Figure 5-8.1** so that the 935AT is looking in both directions.
2. Set your 935AT to **PCM MON-1&2** mode in the **Trunk Type** function key (Refer to **Section 4, PCM Operation**.)
3. Enter **OPTION MENU #: 8 SUPERVISION MONITOR**.



**Figure 5-8.1**  
Measuring ABCD Bit Timing

#### 5-8.2.1.1 PCM: Record

To record results in **PCM** mode:

1. Press **K2** under **RECORD** from the **SUPERVISION MONITOR** display and the 935AT will start recording events. (Follow the instruction outlined in **Section 5-8, Analog Connections** before proceeding.)
2. Press **K4** under **EXIT** when you have recorded enough events (you can see the front panel supervision **LEDs** changing the **A** and **B** states. You will be returned to the main display.

## Section V Option Menu Numbers

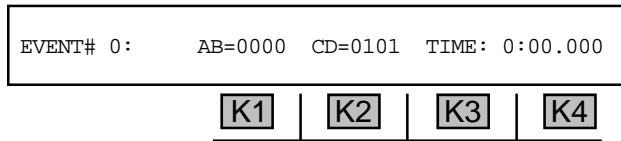
---

### 5-8.2.1.2 PCM: Review

---

To review results in **PCM** mode:

1. Press **K3** under **REVIEW** and the first event will be shown.



**EVENT # 0:** will always display first; this is usually an on-hook state for **metallic** trunk types. In **PCM**, the individual **A, B, C, D**, states are displayed whether on or off hook.

2. Use the **Up/ Down Arrow** keys or any softkey (**K1-K4**) to scroll through the list of the results. When you have reached the end of the results, the softkeys and **Up Arrow** key will become inactive. Pressing the **Left Arrow** key will return you to **EVENT #0** and pressing the **Right Arrow** key will advance to the maximum recorded **EVENT #**, skipping all interim events.
3. Press the **Option Menu** function key to exit to the previous display, or press it a second time to return to the main display.

### 5-8.2.1.3 Print

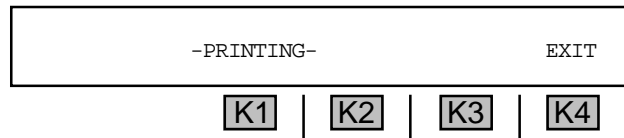
---

To **print** out the results to date:

1. Press **K3** under **PRINT** in the supervision monitor display.

If **PRINTER** mode has not been selected, the display reads: **NOT IN PRINTER MODE**. The **935AT** will then return to the main **SETUP** display. (Refer to **Section 6-3, Remote Printing** for setup instructions.)

If in **PRINTER** mode, the display reads:



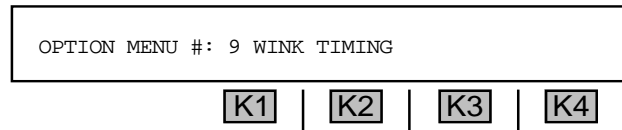
2. Press **K4** under **EXIT** to abort printing. When all records have been printed, the **935AT** returns to the main **SETUP** display.

5-9 OPTION MENU #: 9 WINK TIMING

**OPTION MENU #: 9 WINK TIMING** is a standard feature that enables timing of wink, pre-wink (guard time), and off-hook supervision events. It is used with, and automatically setup by, **OPTION MENU #: 2 SEND DIGIT SEQUENCES** or **OPTION MENU #: 4 DIGIT RECEIVER**.

To set **wink timing**:

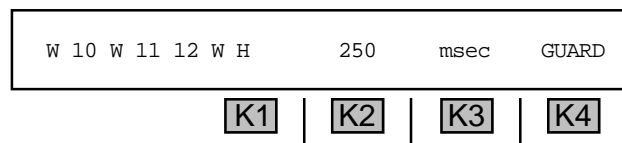
1. Set up a digit sequence in **OPTION MENU #: 2 SEND DIGIT SEQUENCES** or set up the sequence to be received in **OPTION MENU #: 4 DIGIT RECEIVER**.
2. Outpulse the call.
3. Press the **Option Menu** function key.
4. Use the **Up/Down Arrow** keys to scroll through the option menus, **OR** select **9** using the **numeric keypad** and press the **Option Menu** function key. The display reads:



5. Press **ENT** or any softkey (**K1-K4**) to activate your selection.

*for example:*

The display below shows a sequence that was keyed-in under **OPTION MENU #: 2 SEND DIGIT SEQUENCES**.



A flashing cursor will appear over the last completed wink (**w**) or off-hook (**H**) in the sequence. If a wink or off-hook has failed, the cursor will appear over the failed event. If the sequence has not yet been outpulsed, the cursor will appear over the first supervision event and all measurements will be zero.

There will be a measurement (**NNNN msec**) where **NNNN** is the length of time in milliseconds spent waiting for the event (the guard time). The word **GUARD** is displayed to label the measurement. This is the time from the previous event to the beginning of the wink. If the guard time exceeds 16 seconds, the event "fails." In such a case the **GUARD** display reads **>16000 msec**, and the wink or off-hook measurement reads **FAILED**.

6. Use the **Left/Right Arrow** keys to move the cursor within the sequence to examine any supervision event.

Option Menu #: 9

## **Section V Option Menu Numbers**

---

7. Use **K4** to toggle between **GUARD** and **WINK** timing measurement (if the event is a Wink), or **GUARD** and **OFF HOOK** time measurement (if the event is an off-hook). The actual off-hook time is not measured but merely a message that it exceeded the >2sec threshold.

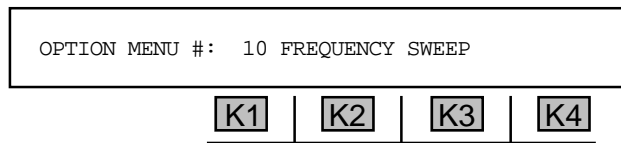
If the event is a wink, it fails if the period exceeds **600 msec**s. If the event is an off-hook, it fails if this period is less than **200 msec**s. You can also use **Wink Timing** to measure Delay Dial events as set up in **Option Menu #: 2** or **Option Menu #: 4**. A Delay Dial event fails if the Guard period exceeds **16 seconds**, or if the off-hook period exceeds **16 seconds**.

## 5-10 OPTION MENU #: 10 FREQUENCY SWEEP

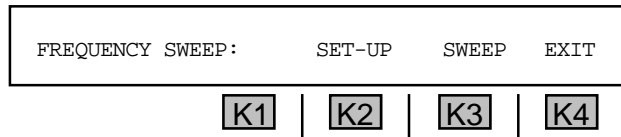
**OPTION MENU #: 10 FREQUENCY SWEEP** is a standard feature that allows the **935AT** to sweep up or sweep down in frequency, either one time or continuously.

To **sweep up or down in frequency**:

1. Press the **Option Menu** function key.
2. Use the **Up/Down Arrow** keys to scroll through the option menus, **OR** select **10** using the **numeric keypad** and press the **Option Menu** function key. The display reads:



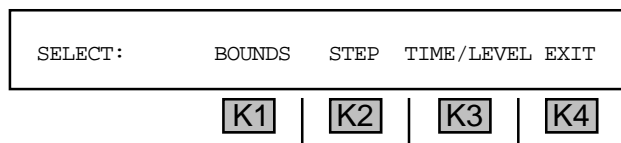
3. Press **ENT** or any softkey (**K1-K4**) to activate your selection. The display reads:



### 5-10.1 Setup

To change the default parameters of the frequency sweep:

Press **K2** under **SET-UP**. The **SELECT** display reads:

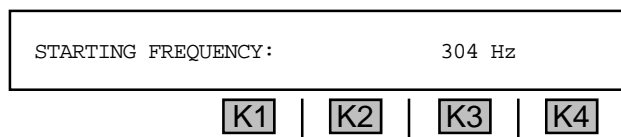


#### 5-10.1.1 Bounds

**BOUNDS** are the beginning and ending frequencies between which the **935AT** will conduct its sweep.

To change the starting or ending **frequency parameters**:

1. Press **K1** under **BOUNDS**. The display reads:



## Section V Option Menu Numbers

---

2. Use the **numeric keypad** to enter a frequency.

- A valid **starting frequency** is between **304** and **3504 Hz**.

3. Press any softkey (**K1-K4**) or **ENT**. The display reads:

ENDING FREQUENCY:	3504 Hz		
<b>K1</b>	<b>K2</b>	<b>K3</b>	<b>K4</b>

4. Use the **numeric keypad** to enter a new frequency.

- A valid **ending frequency** is between **304** and **3504 Hz**.

5. Press any softkey (**K1-K4**) or the **ENT** key. The display reads:

SKIP 2600 Hz?	YES	NO	
<b>K1</b>	<b>K2</b>	<b>K3</b>	<b>K4</b>

6. Press **K2** under **YES** to skip **SF (2600 Hz)** and **Loop Frequency (2713 Hz)** OR **K4** under **NO**. You will be returned to the **SELECT** display.

Option Menu #:  
10

### 5-10.1.2 Step

---

The **STEP** denotes the frequency intervals through which the **935AT** will sweep. (i.e. every 100 Hz.)

To change the **step size**:

1. Press **K2** under **STEP** from the **SELECT** display. The new display reads:

STEP SIZE:	100Hz		
<b>K1</b>	<b>K2</b>	<b>K3</b>	<b>K4</b>

2. Use the **numeric keypad** to enter a new step size and press **ENT** to return to the **SELECT** display.

- A valid **step size** is between **1** and **999 Hz**.

### 5-10.1.3 Time/Level

---

**TIME** refers to the time interval that the **935AT** pauses at each frequency step.  
**LEVEL** is the level of the send tone.



To change the **step interval and level**:

1. Press **K3** under **TIME/LEVEL**. The display reads:

TIME BETWEEN STEPS:	3.5 SEC		
<b>K1</b>	<b>K2</b>	<b>K3</b>	<b>K4</b>

2. Use the **numeric keypad** to enter a new pause between steps.

- A valid **step interval** between steps is between 0.1 and 9.9 SEC.

3. Press **ENT**. The display will advance to the **LEVEL** field:

LEVEL:	-16.0 dBm		
<b>K1</b>	<b>K2</b>	<b>K3</b>	<b>K4</b>

4. Use the **numeric keypad** to enter a new level and then press **K4** under **EXIT** to return to the main **SWEEP** selection display.

- A valid **step level** is between -40 and -16.0 dBm.

## 5-10.2 Sweep

To **sweep** a frequency range:

1. Press **K3** from the **FREQUENCY SWEEP** display. The new display reads:

DISPLAY:	MEASURE	SEND	
<b>K1</b>	<b>K2</b>	<b>K3</b>	<b>K4</b>

2. Press **K4** under **SEND** if you want to display what you are sending, **OR** press **K2** under **MEASURE** if you require a measurement. The measure function will display the measured frequency as you sweep on the transmit. The display reads:

SELECT:	CONTINUOUS	SWEEP ONCE	
<b>K1</b>	<b>K2</b>	<b>K3</b>	<b>K4</b>

3. Press **K2** under **CONTINUOUS** to continuously repeat the sweep, **OR** press **K4** under **SWEEP ONCE** to sweep only one time. You will immediately hear the sweep tone, and the **935AT** will display the expected transmitted or received frequency as the sweep continues. In the **Measure** mode, this is the received level and frequency. The **935AT** will display the outgoing frequency and level if it is not in the **Measure** mode.

## Section V Option Menu Numbers

### 5-11 OPTION MENU #: 11 IMPULSE NOISE & HITS

**OPTION MENU #: 11 IMPULSE NOISE & HITS** is only available when *Purchase Option 935AT-100, Fax/Modem TIMS Package* has been installed. It is used in conjunction with **OPTION MENU #: 18 PHASE AND AMPLITUDE JITTER**. This feature enables you to access the impulse noise and hits function and measure of the transients known as Phase Hits, Gain Hits, and Dropouts.

To access the **impulse noise and hits** function:

1. Press the **Option Menu** function key.
2. Use the **Up/Down Arrow** keys to scroll through the option menus, **OR** select **11** using the **numeric keypad** and press the **Option Menu** function key. The display reads:

OPTION MENU NUMBER: 11 IMPULSE NOISE & HITS			
K1	K2	K3	K4

3. Press **ENT** or any softkey (**K1-K4**) to activate your selection. The display reads:

IMPULSE/HITS:	DEFAULT	MEASURE	SET-UP
K1	K2	K3	K4

4. Press **K2** under **DEFAULT** to set the **935AT** to **4 dB** spread and **7** measurements per second. The **935AT** will display **DEFAULTS SET** momentarily. The default threshold for **PCM** is **67 dBrnC** and for **Analog** is **54 dBrnC**.
5. Press **K3** under **MEASURE** if you want to measure with the default settings. The display will advance to the start display beginning in **Section 5-11.2**.

#### 5-11.1 Setup

For a setup other than the default specifications shown above:

Press **K4** under **SET-UP**.

In wideband, the **SETUP** display is preceded by the **FILTER** display:

FILTER:	C-NOTCH	E-FILTER	50K-BIT	MORE
K1	K2	K3	K4	

To change any of the **filters** in **wideband**:

1. Press the appropriate softkey. (Only **C-NOTCH** is available for voiceband operation.) In wideband, phase hits and gain hits options are not available.
2. If the cursor already highlights your selection, you may either press the softkey under that selection or press **K4** under **MORE** to advance to the **SETUP** display.

The **SETUP** display in **voiceband** and **wideband** reads:

THRESH:	67dBrc	SPRD:4dB	8M/S	MORE
<b>K1</b>	<b>K2</b>	<b>K3</b>	<b>K4</b>	

(In **analog** and **wideband**, the Threshold is **54 dBrc**, in **PCM** it is **67 dBrc**.)

### 5-11.1.1 Threshold

To change the **noise threshold**:

1. Press **K1**. The display reads:

SET THRESHOLD:	67dBrc	[30-102]	
<b>K1</b>	<b>K2</b>	<b>K3</b>	<b>K4</b>

2. Use the **numeric keypad** to enter a new threshold.

- A valid **threshold** is between **30** and **102 dBrc** in **analog** and **PCM**, and between **50** and **99 dBrc** in **wideband**.

3. Press any softkey (**K1-K4**) to return to the second setup display.

### 5-11.1.2 Spread

To change the **spread**:

1. Press **K2** under **SPRD: N dB** from the **THRESH** display. The next display reads:

SPRD:	+8dB	+6dB	+4dB	+2dB
<b>K1</b>	<b>K2</b>	<b>K3</b>	<b>K4</b>	

**8 dB spread is not available with thresholds above 96 dBrc.**

2. Press the appropriate softkey. You will be returned to the second setup display.

## Section V Option Menu Numbers

### 5-11.1.3 Measurements Per Second

To enter the desired **measurements per second**:

1. Press **K3**. The display reads:

MEASUREMENTS PER SECOND:	8	[1-99]	
<b>K1</b>	<b>K2</b>	<b>K3</b>	<b>K4</b>

2. Use the **numeric keypad** to enter a new number of measurements per second.

- A valid number of **measurements per second** is between 1 and 99 in **voiceband**, and between 5 and 99 in **wideband**.

3. Press **ENT** or any softkey (**K1-K4**) to return to the **SETUP** display.

### 5-11.1.4 PH/GH Thresholds and Test Length

To select the appropriate **test length**:

1. Press **K4** under **MORE**. In **voiceband**, the display reads:

THRESH:	PH=20°	GH=3dB	15 MIN	EXIT
<b>K1</b>	<b>K2</b>	<b>K3</b>	<b>K4</b>	

(In **wideband**, the **935AT** skips this display and advances to step 5.)

2. Press **K1** to change the phase hit (**PH**) threshold, **OR** **K2** to change the gain hit (**GH**) threshold. The display reads either **ENTER PHASE HIT THRESHOLD** or **ENTER GAIN HIT THRESHOLD**.

3. Use the **numeric keypad** to enter new threshold values.

- A valid **phase hit threshold** is from 1° to 45°.
- A valid **gain hit threshold** is between 1 dB and 10 dB.

4. Press **ENT**. You will be returned to the **THRESH** display.

5. Press **K3** under **15MIN**. The display reads:

TEST LENGTH:	15 MIN CONTINUOUS	EXIT	
<b>K1</b>	<b>K2</b>	<b>K3</b>	<b>K4</b>

6. Press **K3** to select **CONTINUOUS** measurement OR use the **numeric keypad** to change the measurement interval displayed above **softkeys 1** and **2**.

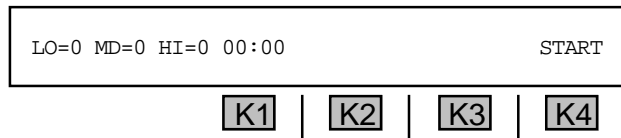
• A valid **interval** is between **1** and **99** minutes. The default is 15 minutes (**15 MIN**)

7. Press **K4** under **EXIT**. The **935AT** will proceed to the start display below. (You will also reach this display by pressing **K3** under **MEASURE** in the main **Impulse/Hits** display.)

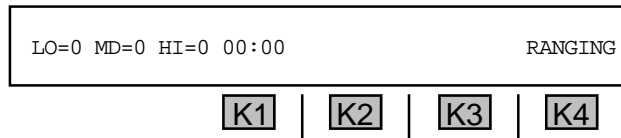
### 5-11.2 Measure

To begin **measuring**:

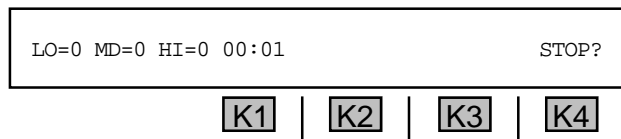
1. Press **K3** under **MEASURE** from the **Impulse/Hits** display. If you have completed the previous setup instructions for non-default parameters, the display reads:



2. Press **K4** under **START** when you are ready to start testing. The display reads:



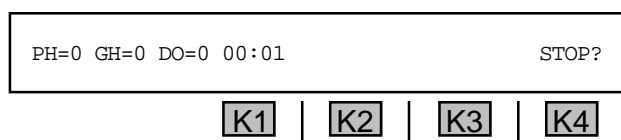
This display is only momentary and is replaced by the measurement display:



If you need to stop the test, press **K4** under **STOP**. Otherwise the test will accumulate impulse noise as selected under the **TEST LENGTH** display.

If the test is to be performed with holding tone over a loopback circuit, the **935AT** should be set to send **1004 Hz** at **-13.0 dBm** using the **Send Tone** function. If the received holding tone drops below **-40.0 dBm** during the test, the words **NO TONE!** appears above **K4**.

3. Press any softkey (**K1-K4**) to display the **Phase Hits**, **Gain Hits**, and **Dropouts**. The display reads:



4. Press the **Option Menu** function key to exit.

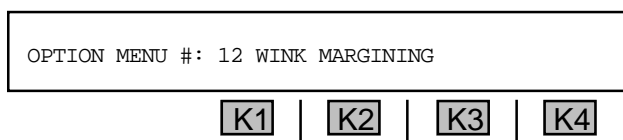
## Section V Option Menu Numbers

### 5-12 OPTION MENU #: 12 WINK MARGINING

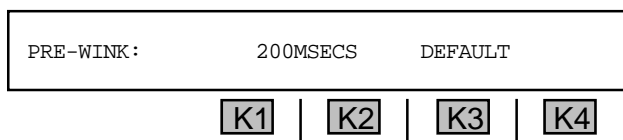
**OPTION MENU #: 12 Wink Margining** is a standard feature that lets you change the length of time the **935AT** will wait (**200 milliseconds**) after it sees a seizure before it gives back a wink. This is called the pre-wink time or guard time.

To change the **default margining**:

1. Press the **Option Menu** function key.
2. Press the **Up/Down Arrow** keys to scroll through the option menus, **OR** select **12** using the **numeric keypad** and press the **Option Menu** function key. The display reads:



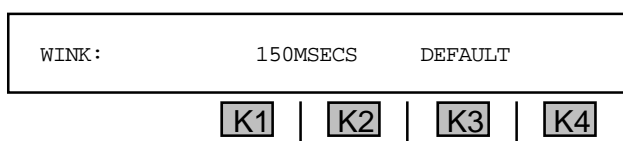
3. Press **ENT** or any softkey (**K1-K4**) to activate your selection. The display reads:



4. Use the **numeric keypad** to change the displayed pre-wink time, **OR** press **K3** under **DEFAULT** to accept it.

- A valid **pre-wink time** is between **75** and **999 MSECS**. The default value is **200 MSECS** with an accuracy of  $\pm 10$  **MSECS**.

5. Press **ENT**. The display reads:



6. Use the **numeric keypad** to change the displayed wink time, **OR** press **K3** under **DEFAULT** to accept the default value. The wink time is the number of milliseconds the **935AT** will remain off-hook during a wink.

- A valid **wink time** is between **35** and **999 MSECS**. The default value is **150 MSECS** with an accuracy of  $\pm 10$  **MSECS**.

7. Press **Option Menu** function key to exit the display.

5-13 OPTION MENU #: 13 PHASE & AMPLITUDE JITTER

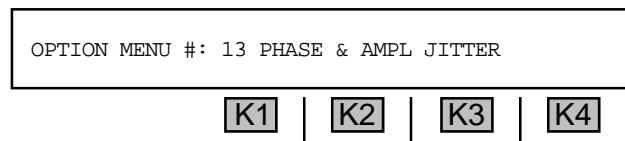
**OPTION MENU #: 13 PHASE & AMPLITUDE JITTER** is only available when *Purchase Option 935AT-100, Fax/Modem TIMS Package* is installed. This feature, working in conjunction with 3-Level Impulse Noise (part of the same Purchase Option), enables you to measure Phase and Amplitude Jitter on Voice Frequency channels and to measure transient phenomena such as Phase Hits, Gain Hits, and Dropouts.

The Phase and Amplitude Jitter measurements are displayed under **OPTION MENU #: 13** and the Hits are counted with Impulse Noise under **OPTION MENU #: 11**.

**Phase/Amplitude jitter** is a dithering of the phase which appears as phase or frequency modulation. It is measured by sending a test tone of **1004 Hz**. At the receive end, a phase locked loop establishes a phase reference and jitter is measured relative to this reference. Phase jitter measurements are made over a **4 Hz to 300 Hz** range in three bands: **4 Hz to 20 Hz**, **20 Hz to 300 Hz** and the entire **4 Hz to 300 Hz** band. Jitter standards for data transmission are no more than **10°** between **20 Hz** and **300 Hz** and **15°** between **4 Hz** and **300 Hz**.

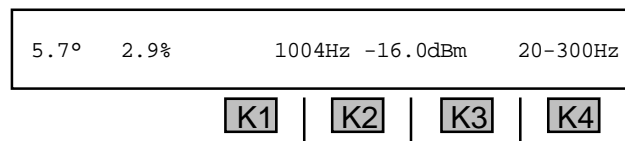
To measure **phase and amplitude jitter**:

1. Connect the **935AT** to the trunk under test.
2. Perform a **C-Message Noise** measurement prior to measuring phase jitter. Excess noise can cause what appears to be significant amounts of jitter. (Readings should be less than **20 dBmC** for quiet terminated line.)
3. Press the **Option Menu** function key.
4. Use the **Up/Down Arrow** keys to scroll through the option menus, **OR** select **13** using the **numeric keypad** and press the **Option Menu** function key. The display reads:



5. Press **ENT** or any softkey (**K1-K4**) to activate your selection. The **935AT** begins measuring phase and amplitude jitter over the filter bandwidth of **20 Hz to 300 Hz** and displays the level and frequency of the received holding tone.

*for example:*



**Phase jitter** requires a test signal between **995 Hz** and **1020 Hz**. (**1010 Hz nominal**). If the actual frequency of the test tone differs by more than **±20 Hz** from the nominal value, or is below **-40 dBm** in level, the **935AT** will indicate **INVALID TONE**:

Option Menu #: 13

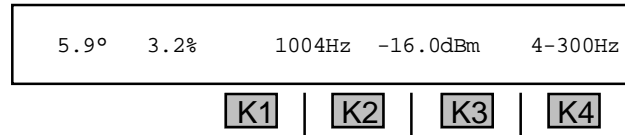
## Section V Option Menu Numbers

---

If you receive an invalid tone, you should press the **Option Menu** key to stop testing and return to the main display to check your setup and connections. If a tone is valid, the display will show the measurements.

6. Press **K4** under **20-300 Hz** to change the filter bandwidth selection from **20-300 Hz** to **4-300 Hz**.

*for example:*



If the readings are relatively the same in the **20 - 300 Hz** test and the **4 - 300 Hz** test, then the source of the excess jitter probably has a fundamental frequency above **20 Hz** since there are no significant contributions to the levels from below **20 Hz**.

Between **20 Hz** and **300 Hz** the most significant source of jitter is the **60 Hz** AC power line frequency and its 2nd through 5th harmonics (**120 Hz, 180 Hz, 240 Hz, 300 Hz**).

7. Press the **Option Menu** function key to exit this function.

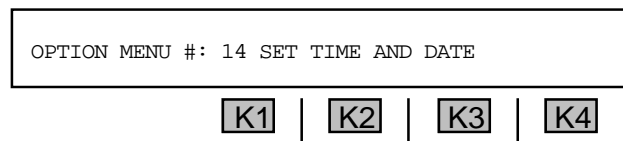


## 5-14 OPTION MENU #: 14 SET TIME AND DATE

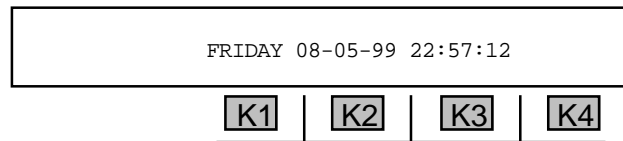
**OPTION MENU #: 14 SET TIME AND DATE** is a standard feature that enables you to set the time and date stamp on the 935AT.

To set the **time** and **date**:

1. Press the **Option Menu** function key.
2. Use the **Up/Down Arrow** keys to scroll through the option menus, **OR** select **14** using the **numeric keypad** and press the **Option Menu** function key. The display reads:



3. Press **ENT** or any softkey (**K1-K4**) and the currently stored time and date will appear. The cursor is over the day of the week.



4. Use the **Left/Right Arrow** keys to position the cursor over the day, date or time field.
5. Use the **Up/Down Arrow** keys to change the parameter under the cursor or, for the date and time, you can also use the **numeric keypad** to enter the number directly.
6. Press the **Option Menu** function key to exit this function.

## Section V Option Menu Numbers

---

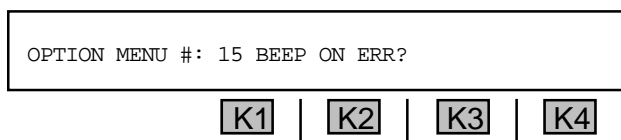
### 5-15 OPTION MENU #: 15 BEEP ON ERR?

---

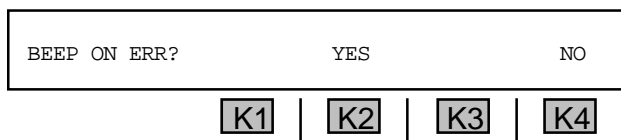
**OPTION MENU #: 15 BEEP ON ERR?** is a standard feature that provides you with the ability to turn on/off the audible beep that indicates various types of errors, generally **PCM**. Disabling the beep does not prevent the **935AT** from sending the “Bell” character (ASCII 07) to a remote printer, terminal, or computer. (Refer to **Section 6, Remote Control Operation** for more information.)

To turn the **beep on/off**:

1. Press the **Option Menu** function key .
2. Press the **Up/Down Arrow** keys to scroll through the option menus, **OR** select **15** using the **numeric keypad** and press the **Option Menu** function key. The display reads:



3. Press **ENT** or any softkey (**K1-K4**) to activate your selection. The display reads:



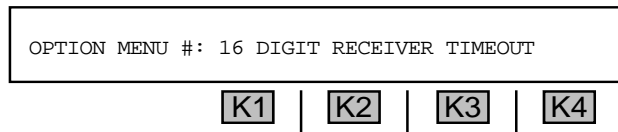
4. Press **K4** under **NO** to turn the beep **off**, **OR** press **K2** under **YES** to turn the beep **on**.
5. Press the **Option Menu** function key to exit this function.

## 5-16 OPTION MENU #: 16 DIGIT RECEIVER TIMEOUT

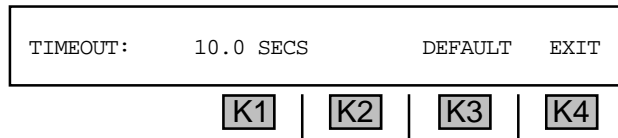
**OPTION MENU #: 16 Digit Receiver Timeout** is a standard feature that allows the **935AT** to set a timeout for the digit receiver. If the timeout elapses while the digit receiver is expecting a digit, the **935AT** closes the digit record. This allows the digit receiver to be used more easily when an unknown number of **DTMF** or dial pulse digits are expected.

To set the **digit receiver timeout**:

1. Press the **Option Menu** function key.
2. Press the **Up/Down Arrow** keys to scroll through the option menus, **OR** select **16** using the **numeric keypad** and press the **Option Menu** function key. The display reads:



3. Press **ENT** or any softkey (**K1-K4**) to activate the selection. The display reads:



4. Use the **numeric keypad** to enter a timeout.

- A valid timeout is between **0.1** and **99999.9 SECS**.
- If you are in **OPEN** mode in the dry circuit Trunk Type, set the timeout to **99999.9 SECS**.
- The **default** is **10.0 SECS**. (Pressing **K3** sets the timeout to the default.)

If you do not set the timeout to **99999.9 SECS**, the **935AT** may not have adequate time to receive the digits. (After the first record is complete, it may take longer than 10 seconds to receive the digits for the second, third and consecutive records.) The **935AT** will not perform accurately Return to **OPTION MENU #:16 DIGIT RECEIVER TIMEOUT** to reset the timer to **99999.9 SECS**.

5. Press **K4** under **EXIT** when complete.
6. Select **OPTION MENU #: 4 DIGIT RECEIVER** to complete the procedure. (Refer to **Section 5-4, Option Menu #: 4 Digit Receiver** for more information on receiving digits.)

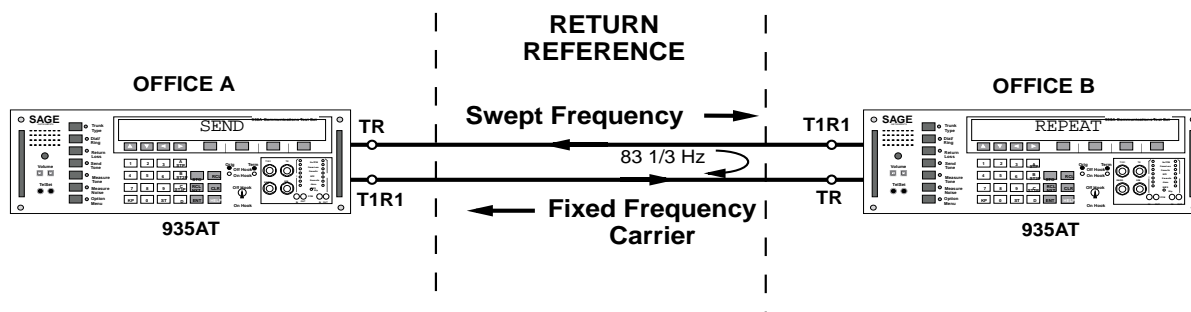
### 5-17 OPTION MENU #: 17 ENVELOPE DELAY

**OPTION MENU #: 17 ENVELOPE DELAY** is available only when *Purchase Option 935AT-100 FAX/Modem TIMS Package* is installed. Envelope Delay Distortion (EDD) is always an end-to-end test. It requires test sets at both ends of the circuit and a 4-wire transmission path. One end is set up in the **REPEAT** (or Slave) mode, and the other end is set up in **SEND** (or Master) mode. The **SEND** unit transmits a single frequency (usually **1804 Hz**) to establish a reference delay. This delay is “zeroed out,” and the **SEND** unit sends a frequency sweep while the **REPEAT** unit continues sending reference. The **SEND** unit measures delay in microseconds relative to the reference. The **SEND** end then transmits the reference frequency while the **REPEAT** end sweeps the returned carrier. All delay measurements are made at the **SEND** end. These tests are commonly referred to as Return Reference and Forward Reference measurements.

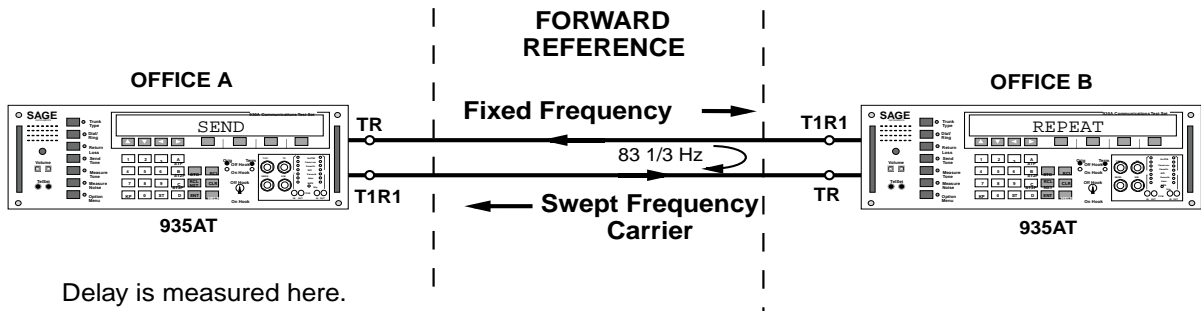
**Envelope Delay Distortion** results when different frequencies travelling along a circuit arrive at different times, even though the frequencies were transmitted together. This occurs when the rate of change of phase shift with frequency over the bandwidth of interest is not constant. EDD measurements are usually stated as one-half the difference between the delays of the two frequency extremes of the band of interest.

An **envelope delay distortion** measurement proceeds as shown below:

Option Menu #:  
17

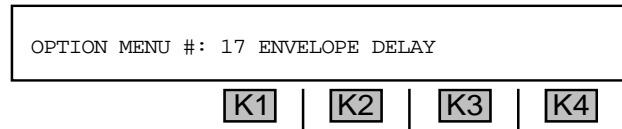


1. Office A sends an amplitude-modulated signal over the trunk under test.
2. Office B strips off the modulation and applies it to a carrier.
3. Office A recovers the returned modulation and compares it to that being sent. The difference in phase is proportional to the envelope delay.
4. The delay at a reference frequency is used as a zero reference, and a frequency sweep is then performed by the **SEND** unit. The delay at the other frequencies is measured in microseconds relative to the reference.
5. The **SEND** unit sends the reference frequency while the **REPEAT** unit sweeps the returned carrier. This allows the **SEND** unit to measure the delay on the return path.

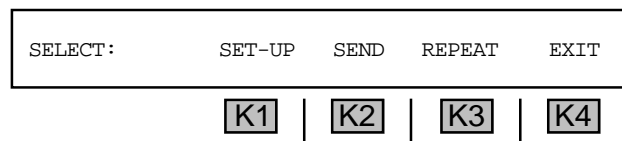


To use the **envelope delay distortion measurement function**:

1. Decide at this point which unit will be the **SEND** end and which will be the **REPEAT** end. **Envelope Delay** operates on any 4-wire trunk type that does not have DC supervision on T/R and T1/R1 connections. Operation in other trunk types will result in degraded accuracy.
2. Press the **Option Menu** function key.
3. Use the **Up/Down Arrow** keys to scroll through the option menus, **OR** select **17** using the **numeric keypad** and press the **Option Menu** function key. The display reads:



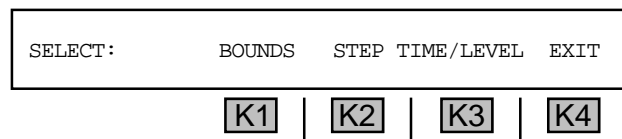
4. Press **ENT** or any softkey (**K1-K4**) to activate your selection. The display reads:



### 5-17.1 Setup

To select the **envelope delay distortion measurement parameters**:

1. Press **K1** under **SET-UP**. The display reads:



Option Menu #: 17

## Section V Option Menu Numbers

---

The **935AT** default parameters have been preset to sweep from **304 Hz** to **3504 Hz** in **100 Hz** steps at a level of **-16 dBm** and a time between steps of **3.5** seconds with the SF frequency (**2600 Hz**) skipped.

### 5-17.1.1 Bounds

---

**BOUNDS** are the beginning and ending frequencies between which the **935AT** will conduct its frequency sweep.

To change the starting or ending **frequency parameters**:

1. Press **K1** under **BOUNDS**. The display reads:

STARTING FREQUENCY:	304 Hz		
<b>K1</b>	<b>K2</b>	<b>K3</b>	<b>K4</b>

2. Use the **numeric keypad** to enter a new frequency.

- A valid **frequency** is between **304** and **3504 Hz**.

3. Press **ENT** or any softkey (**K1-K4**). The display reads:

ENDING FREQUENCY:	3504 Hz		
<b>K1</b>	<b>K2</b>	<b>K3</b>	<b>K4</b>

4. Use the **numeric keypad** to enter a frequency. If your starting frequency is less than your ending frequency, the frequency will decrement according to the **Step** and **Time/Level** you have indicated until it reaches your ending frequency and will then stop.

5. Press **ENT** or any softkey (**K1-K4**). The display reads:

SKIP 2600 Hz?	YES	NO	
<b>K1</b>	<b>K2</b>	<b>K3</b>	<b>K4</b>

6. Press **K2** under **YES** to skip **SF (2600 Hz)** **OR** **K4** under **NO** if you do not want to skip **SF**. The display will return to the **SELECT** display.

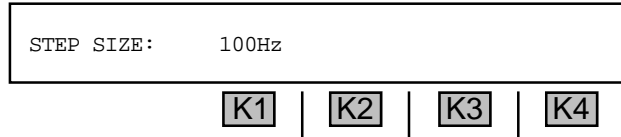
### 5-17.1.2 Step

---

The **STEP** denotes the frequency intervals at which the **935AT** will send its tones. (e.g., every 100 Hz.)

To change the **step size**:

1. Press **K2** under **STEP** from the **SELECT** display. The new display reads:



2. Use the **numeric keypad** to enter a new step size and press **ENT** to return to the **SELECT** display.

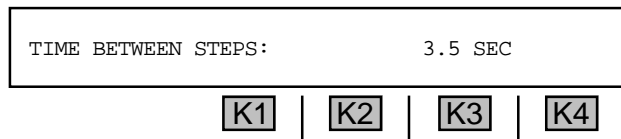
- A valid **step size** is between 1 and 999 Hz.

### 5-17.1.3 Time/Level

**TIME** is the time interval that the **935AT** pauses at each frequency step.  
**LEVEL** is the level of the send tone.

To change the **time interval**:

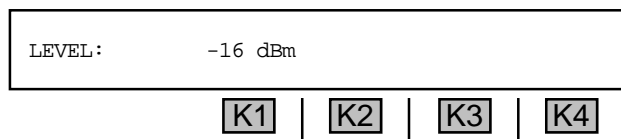
1. Press **K3** under **TIME/LEVEL**. The display reads:



2. Use the **numeric keypad** to enter a new pause between steps.

- A valid **time interval** is between 0.1 and 9.9 SEC.

3. Press **ENT**. The display will advance to the **Level** field. The display reads:



4. Use the **numeric keypad** to enter a new level.

- A valid **level** is between -40 and 0 dBm. The default level is -16.0 dBm.

Since this display is taken directly from **OPTION MENU # 10: FREQUENCY SWEEP**, levels may be entered from **+12.0 dBm** to **-60.0 dBm** and they will appear to be accepted. However, the **935AT** will only transmit over the **0 dBm** to **-40.0 dBm** range allowed in Envelope Delay Distortion measurements.

5. Press **K4** under **EXIT** to return to the main **EDD** selection display. Once the **935AT** has been set up, it is not necessary to reenter the **SET-UP** display to start testing.

## Section V Option Menu Numbers

### 5-17.2 Send

To send a signal in **EDD** mode:

1. Press **K2** under **SEND** from the **EDD SELECTION** display. The display advances to:

4104 $\mu$ S	1804Hz	-16dBm	<-SEND	SETREF
<b>K1</b>	<b>K2</b>	<b>K3</b>	<b>K4</b>	

This display shows the calculated phase delay in microseconds for the return reference signal from the **REPEAT** unit, and the level and frequency of the signal being sent from the **SEND** unit. All measurements of **EDD** are made at the **SEND** end of the circuit. **EDD** is also a referenced measurement.

2. Press **K2** under the frequency. The cursor will move to the last digit of the frequency.
3. Use the **numeric keypad** to change the frequency and press **ENT OR** use the **Up/Down Arrow** keys to scroll through the possible selections.

- A valid **frequency** is between 304 Hz and 3504 Hz.

4. Press **K2** under the level. The cursor will move to the last digit of the level.
5. Use the **numeric keypad** to enter the new level **OR** use the **Up/Down Arrow** keys to scroll through the possible selections and press **ENT** or any softkey.

- A valid **level** is between 0 dBm and -40 dBm.

6. Allow the reading (at the far left of the display) to stabilize before setting the reference delay; wait approximately **15-20** seconds. Press **K4** under **SETREF**.

The current envelope delay reading will become the reference and all subsequent measurements will be relative to this reference. This effectively “zeros out” the current measurement. Once a reference has been established, the frequency or level of the outgoing reference signal can be changed or the frequency sweep can be generated. You will hear a high pitch tone.

The display should resemble the one shown below:

0 $\mu$ S	1804Hz	-16dBm	<-SEND	SWEEP
<b>K1</b>	<b>K2</b>	<b>K3</b>	<b>K4</b>	

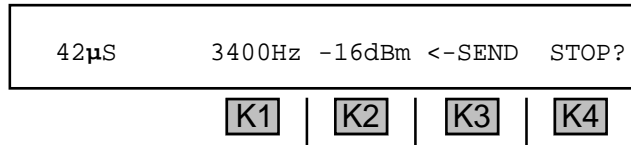
Notice the **SETREF** display has changed to **SWEEP**.

7. Press **K4** under **SWEEP** to send a sweep and perform a Return Reference measurement after setting the reference delay.



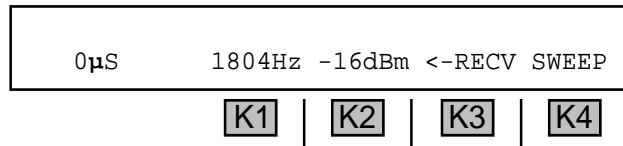
The delay is measured and displayed for each frequency in the sweep. If the **935AT** is in **PRINTER Remote Mode**, the **935AT** automatically prints the delay at each frequency of the sweep. (Refer to **Section 5-3, Option Menu #: 3 Remote Control** or **Section 6, Remote Control Operation**)

8. Press **K4** under **STOP?** to interrupt the sweep, without leaving the **SEND** mode.



When the sweep completes or is interrupted, the **935AT** will revert to sending the reference frequency. **K4** will again be labeled **SWEEP**. The sweep can be repeated or the frequency of the signal can be manually set to examine the delay at frequencies of interest.

9. Press **K3** under **<-SEND** to examine the level and frequency of the returned carrier. The received level and frequency is displayed and the label above **K3** changes to: **<-RECV**.
10. Press **K3** under **<-RECV** to toggle between viewing the outgoing signal and the returned carrier at any time. An example display of the returned reference carrier while sweeping from the **Send** unit is shown below:



The carrier level should be within the **0 dBm** to **-40 dBm** range and steady for the test to be valid.

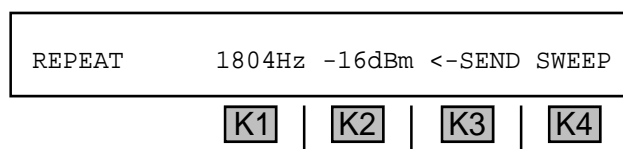
When all of the measurements are complete, the operator at the near-end, (**Send** end) can alert the operator at the far-end to sweep the return carrier. This will allow a Forward Reference measurement to be made of the return path delay. The **Send** unit transmits the fixed reference signal toward the **Repeat** unit, (**Slave** unit) at the far-end.

11. Press **K3** on the **SEND** unit to display the received frequency for the delay.

### 5-17.3 Repeat

To place the **935AT** at the far end of the circuit in **Repeat** mode:

1. Press **K3** under **REPEAT** from the main **SELECT** display. A high pitch tone sounds and the display reads:



## Section V Option Menu Numbers

This display shows the level and frequency of the carrier tone that is being used to return the amplitude modulation to the **Send** unit. The default value is **1804 Hz** at **-16 dBm**.

2. Use the **numeric keypad** to enter a new frequency and press **ENT**.

- A valid **frequency** is between **304 Hz** and **3504 Hz**.

3. Press **K2** under the level. The cursor will move to the last digit of the level.
4. Use the **numeric keypad** to enter the new level and press **ENT**.

- A valid **level** is between **0 dBm** and **-40 dBm**.

5. Press **K3** under **<-SEND** to examine the level and frequency of the signal being received. The display reads:

REPEAT	304Hz	-16dBm	<-RECV	SWEEP
<b>K1</b>	<b>K2</b>	<b>K3</b>	<b>K4</b>	

This display shows the level and frequency of the signal being sent to the **Repeat** unit from the **Send** unit. When the sweep completes, the Return Reference part of the measurement is over. It is then followed by the **Repeat** unit sweeping for the Forward Reference test.

6. Press **K3** to toggle between the received signal and the returned carrier.
7. Press **K4** under **SWEEP** to sweep the returned carrier for a Forward Reference measurement. The display reads:

REPEAT	1804Hz	-16dBm	<-RECV	STOP?
<b>K1</b>	<b>K2</b>	<b>K3</b>	<b>K4</b>	

The **935AT** will begin to sweep the returned carrier through the frequencies that were selected previously.

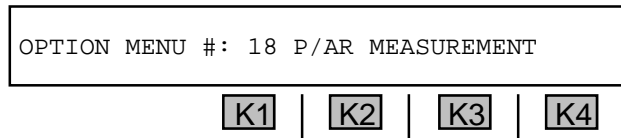
8. Press **K4** under **STOP?** to interrupt the sweep without leaving the **Repeat** mode. When the sweep completes or is interrupted, the **935AT** will revert to sending the reference frequency. **K4** will once again be labeled **SWEEP**.
9. Press the **Option Menu** key to exit this display.
10. Press the **Option Menu** key again or **K4** under **EXIT** to return to the main display.

5-18 OPTION MENU #: 18 P/AR MEASUREMENT

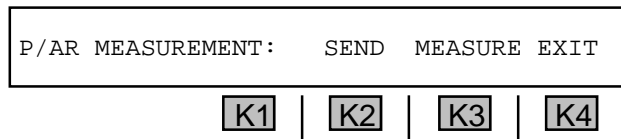
**OPTION MENU #: 18** P/AR Measurement is available only when *Purchase Option 935AT-100, FAX/Modem TIMS Package* is installed. This feature allows you to measure **P/AR (Peak to Average Ratio)** values over a 0 to 200 P/AR unit range.

To measure **P/AR** values:

1. Connect the **935AT** to the circuit under test at the 2- or 4-wire analog trunk access point or at the **DEMARC**. It can also be used on a **T1 PCM** Trunk at the DSX. Before making a P/AR test, set the **935AT** trunk type to the correct settings. (Refer to **Section 3, Front Panel Operation** or **Section 4, PCM Operation** for setup information.)
2. Press the **Option Menu** function key.
3. Use the **Up/Down Arrow** keys to scroll through the option menus, **OR** select **18** using the **numeric keypad** and press the **Option Menu** function key. The display reads:



4. Press **ENT** or any softkey (**K1-K4**) to activate your selection. The display reads:

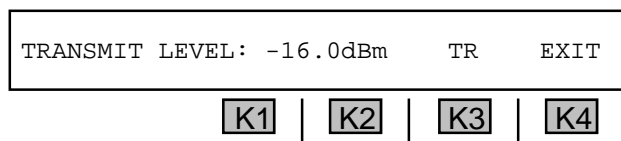


**K2** under **SEND** controls the setup of the **P/AR** transmitter level and also sends the **P/AR** signal on 2- and 4-wire circuits. The setups are retained in nonvolatile memory and need not be accessed every time a measurement is made, unless the level is to be changed.

5. Press **K2** under **SEND** to display the **P/AR** transmit level display if you are testing a 4-wire circuit. (If you are testing a 2-wire circuit, skip to step #8.)

*for example:*

A **4-wire E&M** trunk is shown below:



The test set at the far end of the circuit receives and display the **P/AR** measurement.

## Section V Option Menu Numbers

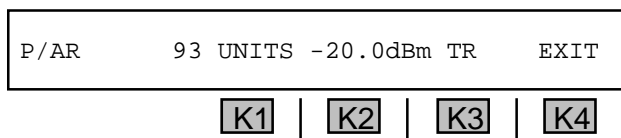
---

6. Use the **numeric keypad** to enter the desired level and press **ENT**.

- A valid **transmit level** in **analog** trunk types is between **-60.0 dBm** and **0 dBm**.
- A valid **transmit level** in **PCM** trunk types is between **-60.0 dBm** and **-13.0 dBm**.

7. Press **K4** under **EXIT** to return to the main **P/AR** display.

8. Press **K3** under **MEASURE** to send and receive the **P/AR** waveform on a 4-wire circuit, or receive **P/AR** on a 2-wire circuit. A **P/AR** measurement display is shown below:



9. Press **K4** to exit.

**P/AR** measurements are end-to-end measurements. On 2-wire circuits, one end transmits while the other receives, then the sender and receiver switch places. One of the test sets must have its transmitter turned off and act as a receiver only. To accomplish this you should press **K3** under **MEASURE** immediately after entering Option Menu #: 18. Pressing **K2** under **SEND** like you do with a 4-wire circuit keeps the **P/AR** transmitter turned on.

On 4-wire circuits, simultaneous transmitting and receiving is possible. When entering **OPTION MENU #: 18 P/AR MEASUREMENT** you should press **K2** under **SEND** first to check or adjust the transmit level before measuring.

5-19 OPTION MENU #: 19 4-TONE INTERMODULATION

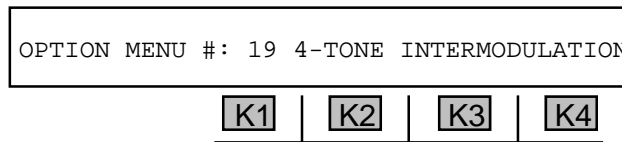
**OPTION MENU #: 19 4-TONE INTERMODULATION** is available only when *Purchase Option 935AT-100, FAX/Modem TIMS Package* is installed. Intermodulation Distortion (IMD) measures the 2nd and 3rd order distortion products created in a nonlinear circuit in the presence of a 4-tone signal.

**Intermodulation Distortion (IMD)**, sometimes referred to as Non-Linear Distortion or 4-Tone Intermod, is an end-to-end measurement. That is, one test set sends the tone pairs at **857 Hz, 863 Hz and 1372 Hz, 1388 Hz** while the other set has its receiver looking at a band of frequencies centered around **520 Hz, 2240 Hz and 1900 Hz**. The energy received in these filters constitutes the energy in the 2nd and 3rd order **IMD** products.

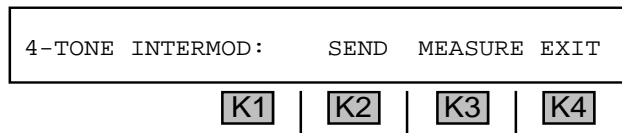
On 4-wire circuits, a loopback can be inserted at the distant end so that one set may send and receive. On a 2-wire circuit, two sets are required. One end transmits while the other receives, then the sender and receiver switch places.

To test for **intermodulation distortion**:

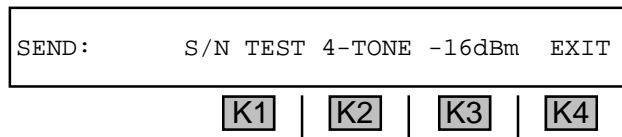
1. Connect the **935AT** to the circuit.
2. Press the **Option Menu** function key.
3. Use the **Up/Down Arrow** keys to scroll through the option menus, **OR** select **19** using the **numeric keypad** and press the **Option Menu** function key. The display reads:



4. Press **ENT** or any softkey (**K1-K4**) to activate your selection. The display reads:



5. Press **K2** under **SEND** to transmit and/or adjust the **IMD** tones being sent to select the signal-to-noise test tones, or to send the Intermod tones over a 2-wire circuit. The display reads:



6. Press **K1** under **S/N TEST** to send the signal-to-noise (**S/N**) test tones. This will suppress one tone pair while amplifying the other pair to maintain the same average level. This measurement is usually performed before **IMD** testing; the **935AT** uses the **S/N** value to automatically correct the **IMD** measurement results for the noise in the same bands.

## Section V Option Menu Numbers

7. Press **K2** under **4-TONE** to send the four intermodulation distortion test tones at the level displayed.

On a 2-wire circuit, another **935AT** or a test set with 4-tone intermodulation distortion measuring capability must be at the far end.

8. Use the **numeric keypad** to change the transmit level and press the **ENT** key.

- For **analog** trunk types, a valid **send level** is between **-40 dBm** and **0 dBm**.
- For **PCM** trunk types, a valid **send level** is between **-40 dBm** and **-6 dBm**.

9. Press **K4** to **EXIT** to the main display. This will not interrupt the tones being sent. From the main display, the test can be terminated, or the **Measure** mode can be selected to test on a 4-wire looped-back circuit.

10. Press the **Option Menu** function key or **K4** under **EXIT** again to terminate testing.

11. Press **K3** under **MEASURE** to measure the **IMD** present on the trunk under test. A typical display is shown below:

-13dBm	2nd: 55dB	3rd: 70dBm	EXIT
--------	-----------	------------	------

K1	K2	K3	K4
----	----	----	----

The first field in the above example is labeled **-13 dBm**. This field shows the composite received level of the four **IMD** tones. If no signal is present this field will be blank. The second field is labeled **2nd: 55 dB** and is the level at which the 2nd order intermodulation (**IM**) products are being received below the level of the four **IMD** tones. In this example, the 2nd order products are **55 dB** below the **IMD** tone level of **-13 dBm** for a total of **-68 dBm**. Similarly, the third field is labeled **3rd: 70 dB** and is the level at which the 3rd order **IM** products are received below the **-13 dBm** signal level.

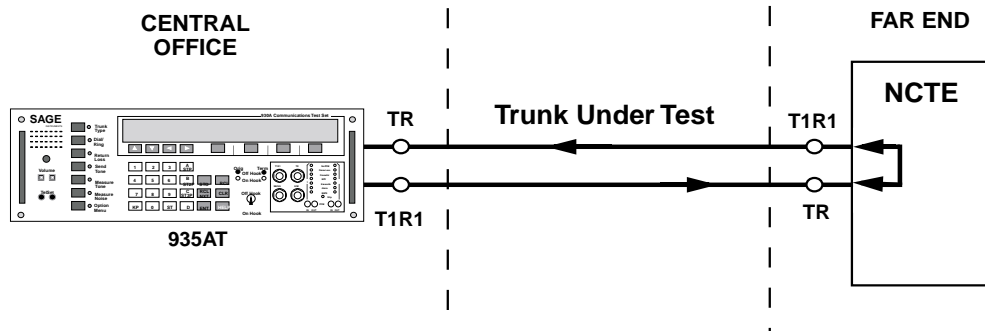
The following messages appear above **K3** indicating conditions of the measured signal:

- The message **INVALID** indicates an invalid signal; i.e., the **IMD** signal is absent, the level is below **-40 dBm**, or too high for the circuit (**>0 dBm** in analog, **>-6 dBm** in **PCM**).
- The message **TWIST** indicates that the **IMD** tones are being received at unequal levels (i.e., they differ by more than **6 dB** from each other).
- The message **SPURIOUS** indicates the presence of a spurious tone (any tone other than the four test tones).
- The message **S/N TEST** shows that the **935AT** is receiving the signal-to-noise test tones. The **2nd** and **3rd** fields contain noise measurements where the distortion products used to be. The measurements are in **dB** below the received signal as a **S/N** ratio.
- The message **ADJUSTED** indicates that the distortion measurements are being corrected automatically for the **S/N** ratio.

5-19.1 Example: 4-Tone IMD Test on a 4-Wire Circuit

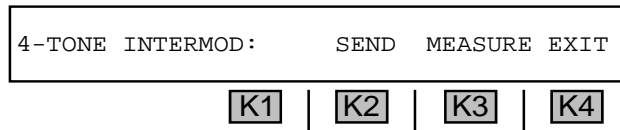
The trunk to be tested is a 4-wire circuit. Network Channel Terminating Equipment (NCTE) is at the far-end which is capable of providing a loopback on the line.

A typical circuit diagram is shown below.

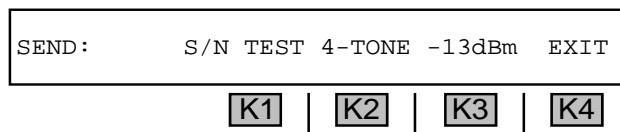


To make a corrected measurement of **IMD**:

1. Select a dry circuit in **Option Menu #: 95 DRY CIRCUIT** and connect the test cords.
2. Press the **Send Tone** function key and set the **935AT** to send **2713 Hz** at **-10 dBm** for **5 seconds** to loop the device at the far-end. (Refer to **Section 3-2.4, Send Tone Function Key.**)
3. Press the **Measure Tone** function key. When the line is looped, the **2713 Hz** tone will be displayed and the tone will be audible. (Refer to **Section 3-2.5, Measure Tone Function Key** for setup information.)
4. Press the **Send Tone** function key again.
5. Press **K4** to turn off the **2713 Hz** tone.
6. Press the **Option Menu** function key.
7. Use the **numeric keypad** to enter **19** and press **ENT**. The display reads:



8. Press **K2** under **SEND**. The display reads:



Option Menu #: 19

## Section V Option Menu Numbers

---

9. Press **K1** under **S/N TEST** and set the level to **-13 dBm**.
10. Press **K4** to **EXIT** to the **4-TONE INTERMOD** display. The **935AT** sends the **S/N** test tones.
11. Press **K3** to select **MEASURE** from the **4-TONE INTERMOD** display. Wait a few seconds for the measurements to stabilize. The received level and the **2nd** and **3rd** fields will contain test results.

*for example:*

```
-13dBm 2nd:31dB 3rd:35dBm S/N TEST EXIT
```

K1	K2	K3	K4
----	----	----	----

12. Press **K4** to exit back to the **4-TONE INTERMOD** display.
13. Press **K2** to select **SEND** from the **4-TONE INTERMOD** display. The new display reads:

```
SEND: S/N TEST 4-TONE -13dBm EXIT
```

K1	K2	K3	K4
----	----	----	----

14. Press **K2** under **4-TONE** and the **935AT** sends the **IMD** test tones at **-13 dBm**.
15. Press **K4** to exit back to the **4-TONE INTERMOD** display.
16. Press **K3** under **MEASURE** from the **4-TONE INTERMOD** display. Wait for the measurement to stabilize. The word **ADJUSTED** should appear to the left of the word **EXIT**.

*for example:*

```
-16dBm 2nd:33dB 3rd:42dBm ADJUSTED EXIT
```

K1	K2	K3	K4
----	----	----	----

17. Press the **Send Tone** key and send the **2713 Hz** tone again to release the loop back before going back on-hook.
18. Press **K4** under **EXIT** to terminate testing.

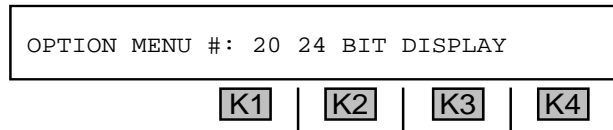


5-20 OPTION MENU #: 20 24 BIT DISPLAY

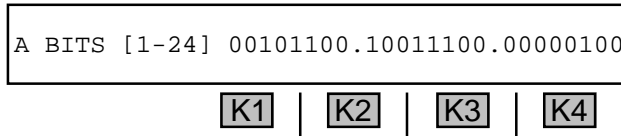
**OPTION MENU #: 20 24-Bit Display** is a standard feature. When you are working on a **T1** span, this option allows you to see the state of the **A** and **B** bits (and the **C** and **D** bits on ESF) on all **24 channels**. With the **935AT**, these bits at the **DSX** monitor jacks can be checked in one or both directions.

To view the **supervision states**:

1. Connect your **935AT** to the **DSX**.
2. Make sure the **935AT** is set to the **PCM** trunk type and that default settings are correct. If it is set to the **MON-1** mode, you will be able to look at the supervision bits on one side at a time. If you are in the **MON-1&2** mode, you can switch from **RECV-1** to **RECV-2**, and look at the supervision bits in each direction, one at a time.
3. Press the **Option Menu** function key.
4. Use the **Up/Down Arrow** keys to scroll through the option menus, **OR** select **20** using the **numeric keypad** and press the **Option Menu** function key. The display reads:



5. Press **ENT** or any softkey (**K1-K4**) to activate your selection. The display reads:



The channels are numbered from **1** to **24**, left to right. The bits have two states, **0** and **1**. Usually a **0** indicates **On-hook** and a **1** indicates **Off-hook** or busy. On a working span, you will see calls completing and terminating, so the display will be changing constantly as calls come and go. On an Extended Superframe span, the **C** and **D** bits will also be displayed.

6. Press any softkey (**K1-K4**) or **Arrow** key to page through the **B**, **C** and **D** bit display.

If you are in **PRINTER** remote mode, the **935AT** will print a copy of its display whenever a bit changes. In **COMPUTER** remote mode, it will send a Bell (ASCII 07) to the computer. (Refer to **Section 6, Remote Control Operation** for more information.)

7. Press the **Option Menu** function key to leave this display.

Option Menu #: 20

**Section V Option Menu Numbers**

---

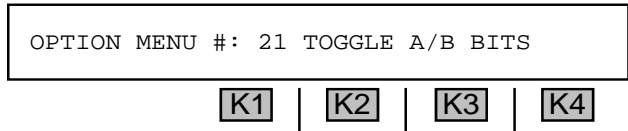
**5-21 OPTION MENU #: 21 TOGGLE A/B BITS**

---

**OPTION MENU #: 21 Toggle A/B Bits** is a standard feature that gives you complete control over A/B/C/D bit states and lets you view their status on the selected channel in both directions while in **TERMINATE** or **D&I** mode.

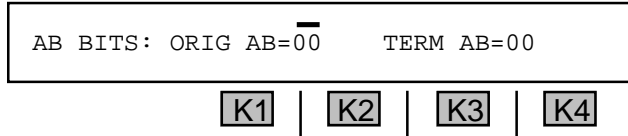
To toggle **A/B** bits:

1. Press the **Option Menu** function key.
2. Use the **Up/Down Arrow** keys to scroll through the option menus, **OR** select **21** using the **numeric keypad** and press the **Option Menu** function key. The display reads:

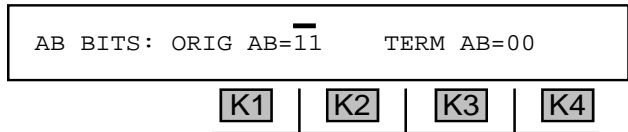


3. Press **ENT** or any softkey (**K1-K4**) to activate your selection. The display reads:

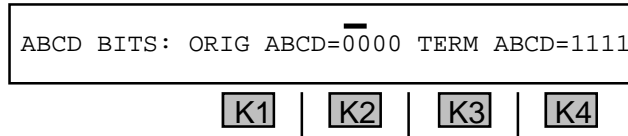
For normal **D4/SF** (Superframe):



For normal **SLC-96**:



For **ESF** (Extended Superframe):



In each of these **T1** span types, the originating end is on-hook. If the **935AT** is in **MON1** mode, blanks will be displayed for the **ORIG** side.

4. Press **1** or **0** on the **numeric keypad** to change the **A bit**. The cursor moves to the next digit. The **TERM** bits come from the **PCM IN** jack in the **RECV** direction. In **TERMINATE**, **D&I** or **MON-1** modes, the **ORIG** bits come from the **935AT**. The **TERM** bits come from the **RECV** side. In **MON1&2** the **ORIG** is the other **PCM** direction.
5. Press the **Option Menu** function key to exit.

Option Menu #: 21

5-22 OPTION MENU #: 22 ABSOLUTE DELAY

**OPTION MENU #: 22 ABSOLUTE DELAY** is available only when *Purchase Option 935AT-100, FAX/Modem TIMS Package* is installed. Absolute Delay provides a Round Trip delay measurement in milliseconds of the total delay for a given circuit. Some specifications for Absolute Delay as compared to Envelope Delay are the following:

- Forward frequency for Absolute Delay will be 1020 Hz.
- Return frequency for both is 1804 Hz.
- The Modulation frequency for both is 83.333 Hz.
- The level of the signal is measured for Absolute Delay.
- Absolute Delay may require an Echo Canceller Disable tone of 2100 Hz.
- The Absolute Delay measurements are to 1 millisecond resolution.

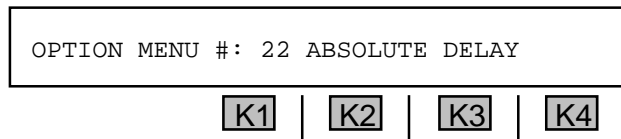
**Absolute delay** is the time interval between transmission and reception of a signal. It is dependent on the length, frequency, and the transmission medium.

5-22.1 Setup and Testing (Send Unit)

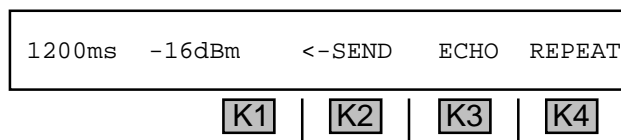
On 4-wire circuits, a loopback can be inserted at the far end so that one set may send and receive. On a 2-wire circuit, two sets are used, with one set sending and receiving, and the other operating as a repeater. Refer to **Section 5-22.2** for information on setting up the repeating unit.

To provide a **round trip delay measurement**:

1. Press the **Option Menu** function key.
2. Use the **Up/Down Arrow** keys to scroll through the option menus, **OR** select **22** using the **numeric keypad** and press the **Option Menu** function key. The display reads:



3. Press **ENT** or any softkey (**K1-K4**) to activate your selection. The display reads:



The **935AT** is now in send mode.

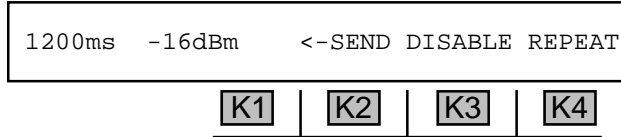
The initial measurement is normally in microseconds and is considered preliminary. The level measurement refers to the level of the signal being sent. The measurement in ms is the round trip delay.

## Section V Option Menu Numbers

---

4. Press **softkey 3** under **ECHO** to send the **2100 Hz** disabling tone to disable the echo canceller.

The display reads:



After a short delay, during which the echo canceller is disabled, the message above **softkey 3** again reads: **ECHO**.

5. Press **softkey 2** to toggle between viewing the level of the **SEND** tone and the **RECEIVE** tone. Note that the round trip delay reading remains the same.
6. If you are in **<-SEND** mode, use the **numeric keypad** to change the send tone level and then press **ENT** or any softkey.

- A valid **send tone level** is between 0 and -40 dBm

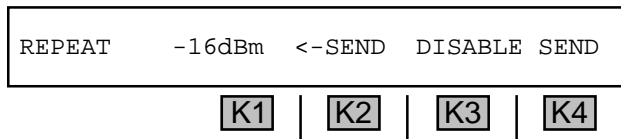
7. Press the **Option Menu** function key to leave this display.

### 5-22.2 Setup and Testing (Repeater)

---

To place the **935AT** at the far end of the circuit in **Repeat** mode (usually in 2W):

1. Press **softkey 4** under **REPEAT** on the **935AT** at the far end. The display reads:



2. Press **softkey 3** under **ECHO** to send the **2100 Hz** disabling tone to disable the echo canceller.
3. Press **softkey 2** to toggle between viewing the level of the **SEND** tone and the **RECEIVE** tone. The send level refers to the repeat tone being sent to the near end, and the receive level refers to the tone being received from the near end.
4. If you are in **<-SEND** mode, use the **numeric keypad** to change the repeat tone level and then press **ENT** or any softkey.

- A valid **repeat tone level** is between 0 and -40 dBm.

5. Press the **Option Menu** function key to leave this display.

## 5-23 OPTION MENU #: 23 SLC-96 CONTROL BITS

**OPTION MENU #: 23 SLC-96 Control Bits** is a standard feature that enables the **935AT** to send or receive the various customer states for the four major Channel Unit types in **SLC-96**, including Single Party, Coin, Universal Voice Grade, and DID.

To use **SLC-96** control bits:

1. Place the **935AT** in **PCM, SLC-96** mode. (Refer to **Section 3-7, Main Function Key Operation** and **Section 4, PCM Operation** for setup information.)
2. Press the **Option Menu** function key.
3. Use the **Up/Down Arrow** keys to scroll through the option menus, **OR** select **23** using the **numeric keypad** and press the **Option Menu** function key. The display reads:

OPTION MENU #: 23 SLC-96 CONTROL BITS

**K1** | **K2** | **K3** | **K4**

4. Press **ENT** or any softkey (**K1-K4**) to activate your selection. If the **935AT** is not in **SLC-96** mode, the display reads: **MUST BE IN PCM WITH SLC-96 FRAMING**. Otherwise, you will see the displays shown on the following pages.

### 5-23.1 Central Office Terminal (COT), Single Party Mode

If in **COT, SINGLE** party mode, the display reads:









CHANNEL TEST <SEND RECV>

**K1** | **K2** | **K3** | **K4**

1. Use the **Up/Down Arrow** keys to scroll through the customer states: **CHANNEL TEST**, **IDLE**, **FWD DISCONNECT**, or **-R RINGING**.
2. Press **K1** or **K2** to **SEND** the selected customer state. The cursor will flash.
3. Press **K1** or **K2** to discontinue sending; the cursor will cease flashing. (For information on Remote Terminal (RT) mode, refer to **Section 5-23.5 Central Office Terminal (COT), DID Mode**).

5-23.1.1 Detailed Description of Single Party Supervision Bits

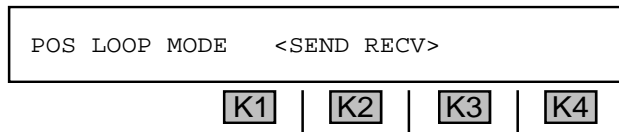
Single Party Supervision

<p>Orig    Term</p> <p>○ Off Hook ○</p> <p>○ On Hook ●</p> <p>Off Hook</p>  <p>On Hook</p>	<p>RT is <b>UNEQUIPPED</b>, COT is <b>IDLE</b></p> <p>RT SEND A=1, B=1    COT SEND A=1, B=1</p> <p>COT hookswitch has no affect.</p> <p>COT Orig. LED will always show <b>ON HOOK</b>, except when ringing.</p>	<p>Orig    Term</p> <p>○ Off Hook ○</p> <p>● On Hook ○</p> <p>Off Hook</p>  <p>On Hook</p>
<p>Orig    Term</p> <p>○ Off Hook ○</p> <p>● On Hook ●</p> <p>Off Hook</p>  <p>On Hook</p>	<p>RT is <b>ON HOOK</b>, COT is <b>IDLE</b></p> <p>RT SEND A=0, B=0    COT SEND A=1, B=1</p> <p>COT hookswitch has no affect.</p> <p>COT Orig. LED will always show <b>ON HOOK</b>, except when ringing.</p>	<p>Orig    Term</p> <p>○ Off Hook ○</p> <p>● On Hook ●</p> <p>Off Hook</p>  <p>On Hook</p>
<p>Orig    Term</p> <p>● Off Hook ○</p> <p>○ On Hook ●</p> <p>Off Hook</p>  <p>On Hook</p>	<p>RT is <b>OFF HOOK</b>, COT is <b>IDLE</b></p> <p>RT SEND A=1, B=0    COT SEND A=1, B=1</p> <p>COT hookswitch has no affect.</p> <p>COT Orig. LED will always show <b>ON HOOK</b>, except when ringing.</p>	<p>Orig    Term</p> <p>○ Off Hook ●</p> <p>● On Hook ○</p> <p>Off Hook</p>  <p>On Hook</p>
<p>Orig    Term</p> <p>○ Off Hook ●</p> <p>● On Hook ●</p> <p>Off Hook</p>  <p>On Hook</p>	<p>RT is <b>ON HOOK</b>, COT is sending <b>RINGING</b></p> <p>RT SEND A=0, B=0    COT SEND A=1, B=1/0</p> <p>COT hookswitch has no affect.</p> <p>COT Orig LED will toggle <b>OFF/ON</b></p> <p>RT Term LED will toggle <b>OFF/ON</b></p>	<p>Orig    Term</p> <p>● Off Hook ○</p> <p>● On Hook ●</p> <p>Off Hook</p>  <p>On Hook</p>

Option Menu #: 23

5-23.2 Central Office Terminal (COT), Coin Mode









If in **COT, COIN** mode, the display reads:



1. Use the **Up/Down Arrow** keys to scroll through the customer states: POS (positive) LOOP MODE, GROUND START, POS COIN CHK, -R RINGING, POS COIN CTRL, NEG COIN CTRL, NEG COIN CHK, NEG LOOP MODE, or CHANNEL TEST.
2. Press **K1** or **K2** to **SEND** the selected customer state. The cursor will flash.
3. Press **K1** or **K2** to discontinue sending; the cursor will cease flashing. (For information on Remote Terminal (RT) mode, refer to **Section 5-23.5 Central Office Terminal (COT), DID Mode.**)

5-23.2.1 Detailed Description of Coin Phone Supervision Bits

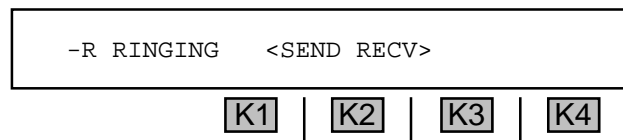
Coin Phone Supervision

<p>Orig    Term  <input type="radio"/> Off Hook <input type="radio"/>  <input checked="" type="radio"/> On Hook ●</p> <p>Off Hook    On Hook</p>	<p>RT is <b>UNEQUIPPED</b>, COT is <b>IDLE</b></p> <p>RT SEND A=1, B=1    COT SEND A=1, B=0</p> <p>COT is sending <b>POSITIVE LOOP MODE</b> for idle.  COT hookswitch has no affect.</p>	<p>Orig    Term  <input type="radio"/> Off Hook <input type="radio"/>  <input checked="" type="radio"/> On Hook ●</p> <p>Off Hook    On Hook</p>
<p>Orig    Term  <input type="radio"/> Off Hook <input type="radio"/>  <input checked="" type="radio"/> On Hook ●</p> <p>Off Hook    On Hook</p>	<p>RT is <b>ON HOOK</b>, COT is <b>IDLE</b></p> <p>RT SEND A=0, B=0    COT SEND A=1, B=0</p> <p>COT is sending <b>POSITIVE LOOP MODE</b> for idle.  COT hookswitch has no affect.</p>	<p>Orig    Term  <input type="radio"/> Off Hook <input type="radio"/>  <input checked="" type="radio"/> On Hook ●</p> <p>Off Hook    On Hook</p>
<p>Orig    Term  <input checked="" type="radio"/> Off Hook ● <input type="radio"/>  <input type="radio"/> On Hook <input checked="" type="radio"/></p> <p>Off Hook    On Hook</p>	<p>RT is <b>OFF HOOK</b>, COT is <b>IDLE</b></p> <p>RT SEND A=1, B=0    COT SEND A=1, B=0</p> <p>COT hookswitch has no affect.  COT Orig. LED will always show <b>ON HOOK</b>, except when ringing</p>	<p>Orig    Term  <input type="radio"/> Off Hook <input checked="" type="radio"/>  <input checked="" type="radio"/> On Hook ● <input type="radio"/></p> <p>Off Hook    On Hook</p>
<p>Orig    Term  <input type="radio"/> Off Hook <input checked="" type="radio"/>  <input checked="" type="radio"/> On Hook ●</p> <p>Off Hook    On Hook</p>	<p>RT is <b>ON HOOK</b>, COT is sending <b>RINGING</b></p> <p>RT SEND A=0, B=0    COT SEND A=1, B=1/0</p> <p>COT hookswitch has no affect.  COT Orig LED will toggle <b>OFF/ON</b>  RT Term LED will toggle <b>OFF/ON</b></p>	<p>Orig    Term  <input checked="" type="radio"/> Off Hook ● <input type="radio"/>  <input checked="" type="radio"/> On Hook ● <input checked="" type="radio"/></p> <p>Off Hook    On Hook</p>

Option Menu #: 23

5-23.3 Central Office Terminal (COT), UVG, Ground Start Mode

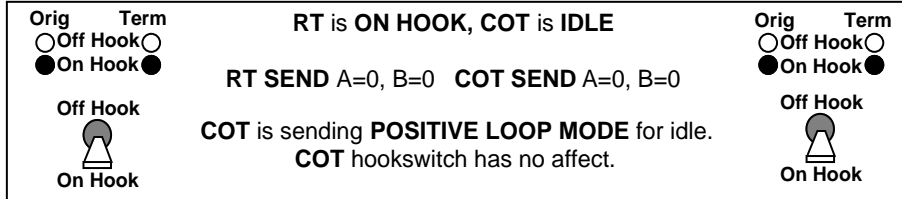
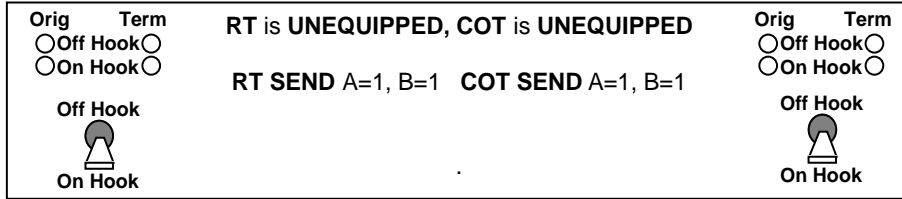
If in **COT**, **UVG** (Universal Voice Grade), Ground Start mode, the display reads:



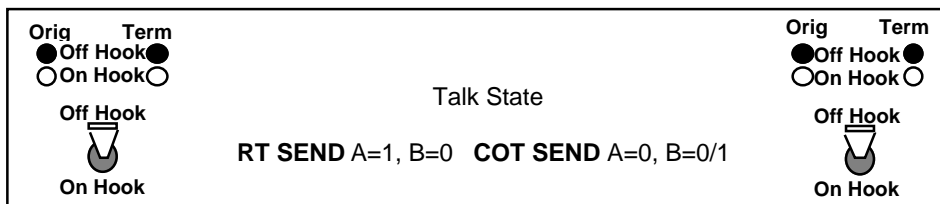
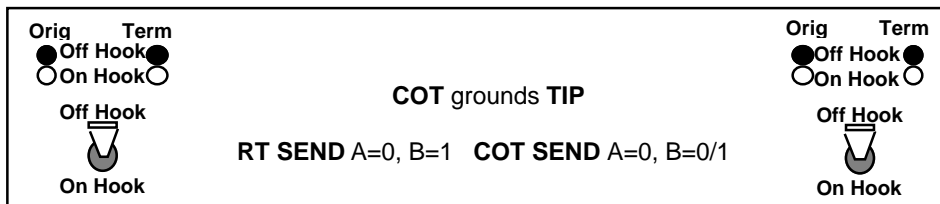
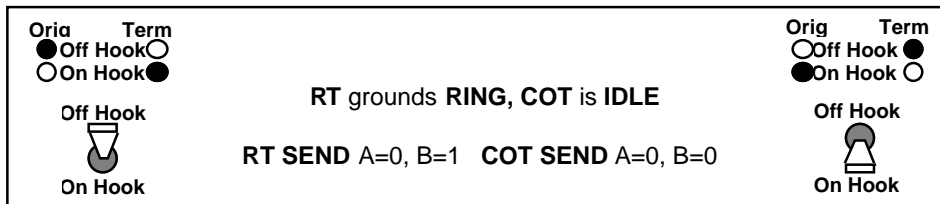
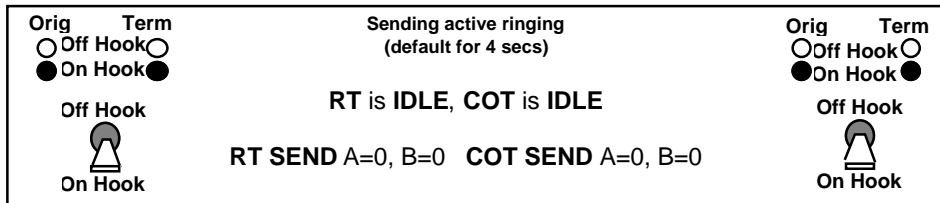
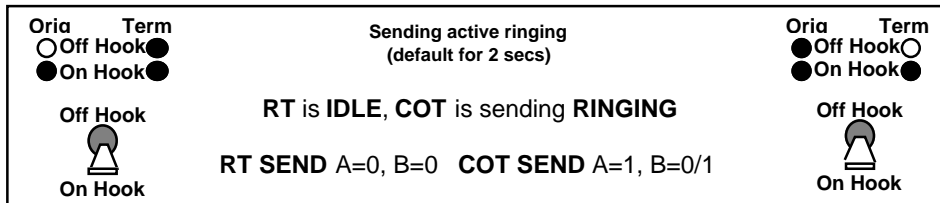
1. Use the **Up/Down Arrow** keys to scroll through the customer states: **-R RINGING**, **IDLE**, **GROUND START**, or **CHANNEL TEST**.
2. Press **K1** or **K2** to **SEND** the selected customer state. The cursor will flash.
3. Press **K1** or **K2** to discontinue sending; the cursor will cease flashing. If the **935AT** is On-Hook, the far right of the display will indicate an **On Hook** state.

5-23.3.1 Detailed Description of UVG, Ground Start Supervision Bits

UVG Supervision Bits (GROUND START)



Ringing Sequence

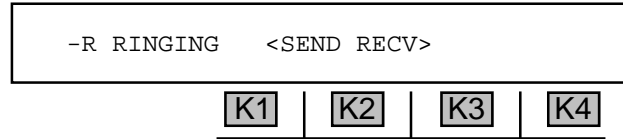


Option Menu #: 23



5-23.4 Central Office Terminal (COT), UVG, Loop Start Mode

If in COT, UVG, LOOP START mode, the display shows:



1. Use the **Up/Down Arrow** keys to scroll through the customer states: **-R RINGING**, **IDLE**, **GROUND START**, or **CHANNEL TEST**.
2. Press **K1** or **K2** to **SEND** the selected customer state. The cursor will flash.
3. Press **K1** or **K2** to discontinue sending; the cursor will cease flashing. The receiver will display all valid commands as they are received.

5-23.4.1 Detailed Description of UVG, Loop Start Supervision Bits

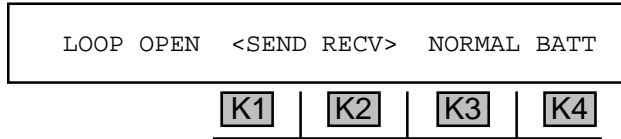
UVG Supervision Bits (LOOP START)

<p>Orig    Term  <input type="radio"/> Off Hook <input type="radio"/>  <input type="radio"/> On Hook <input checked="" type="radio"/></p> <p>Off Hook    On Hook</p>	<p><b>RT is UNEQUIPPED, COT is IDLE</b></p> <p><b>RT SEND A=1, B=1    COT SEND A=1, B=0/1</b></p> <p>COT hookswitch has no affect.</p>	<p>Orig    Term  <input type="radio"/> Off Hook <input type="radio"/>  <input checked="" type="radio"/> On Hook <input type="radio"/></p> <p><del>Off Hook    On Hook</del></p>
<p>Orig    Term  <input type="radio"/> Off Hook <input type="radio"/>  <input checked="" type="radio"/> On Hook <input checked="" type="radio"/></p> <p>Off Hook    On Hook</p>	<p><b>RT is ON HOOK, COT is IDLE</b></p> <p><b>RT SEND A=0, B=0    COT SEND A=1, B=0/1</b></p> <p>COT hookswitch has no affect.</p>	<p>Orig    Term  <input type="radio"/> Off Hook <input type="radio"/>  <input checked="" type="radio"/> On Hook <input checked="" type="radio"/></p> <p><del>Off Hook    On Hook</del></p>
<p>Orig    Term  <input checked="" type="radio"/> Off Hook <input type="radio"/>  <input type="radio"/> On Hook <input checked="" type="radio"/></p> <p>Off Hook    On Hook</p>	<p><b>RT is OFF HOOK, COT is IDLE</b></p> <p><b>RT SEND A=1, B=0    COT SEND A=1, B=0/1</b></p> <p>COT hookswitch has no affect.</p>	<p>Orig    Term  <input type="radio"/> Off Hook <input checked="" type="radio"/>  <input checked="" type="radio"/> On Hook <input type="radio"/></p> <p><del>Off Hook    On Hook</del></p>
<p>Orig    Term  <input type="radio"/> Off Hook <input checked="" type="radio"/>  <input checked="" type="radio"/> On Hook <input checked="" type="radio"/></p> <p>Off Hook    On Hook</p>	<p><b>RT is ON HOOK, COT is sending RINGING</b></p> <p><b>RT SEND A=0, B=0    COT SEND A=1, B=1/0</b></p> <p>COT hookswitch has no affect.  <b>COT Orig LED will toggle OFF/ON</b>  <b>RT Term LED will toggle OFF/ON</b></p>	<p>Orig    Term  <input checked="" type="radio"/> Off Hook <input type="radio"/>  <input checked="" type="radio"/> On Hook <input checked="" type="radio"/></p> <p><del>Off Hook    On Hook</del></p>

**Section V Option Menu Numbers**

**5-23.5 Central Office Terminal (COT), DID Mode**







If in **COT, DID** (Direct Inward Dial) mode, the display shows:



1. Use the **Up/Down Arrow** keys to scroll through the 2 available customer states: **LOOP OPEN** or **LOOPCLOSURE**.
2. Press **K1** or **K2** to **SEND** the selected customer state. The cursor will flash.
3. Press **K1** or **K2** to discontinue sending; the cursor will cease flashing. The receiver will display all valid commands as they are received.

**5-23.5.1 Detailed Description of DID Supervision Bits**

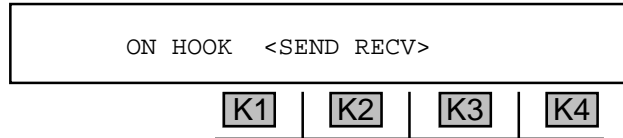
**DID Supervision Bits**

Orig    Term <input type="radio"/> Off Hook <input type="radio"/> <input checked="" type="radio"/> On Hook <input checked="" type="radio"/>  Off Hook  On Hook	<b>RT is ON HOOK, COT is ON HOOK</b>  RT SEND A=0, B=0    COT SEND A=0, B=0  RT is set for <b>NORMAL BATTERY</b> COT is set for <b>LOOP OPEN</b>	Orig    Term <input type="radio"/> Off Hook <input type="radio"/> <input checked="" type="radio"/> On Hook <input checked="" type="radio"/>  Off Hook  On Hook
Orig    Term <input checked="" type="radio"/> Off Hook <input type="radio"/> <input type="radio"/> On Hook <input checked="" type="radio"/>  Off Hook  On Hook	<b>RT is OFF HOOK, COT is ON HOOK</b>  RT SEND A=1, B=1    COT SEND A=0, B=0  RT is set for <b>REVERSE BATTERY</b> COT is set for <b>LOOP OPEN</b>	Orig    Term <input type="radio"/> Off Hook <input checked="" type="radio"/> <input checked="" type="radio"/> On Hook <input type="radio"/>  Off Hook  On Hook
Orig    Term <input checked="" type="radio"/> Off Hook <input checked="" type="radio"/> <input type="radio"/> On Hook <input type="radio"/>  Off Hook  On Hook	<b>RT is OFF HOOK, COT is IDLE</b>  RT SEND A=1, B=1    COT SEND A=1, B=1  RT is set for <b>NORMAL BATTERY</b> COT is set for <b>LOOP CLOSURE</b>	Orig    Term <input checked="" type="radio"/> Off Hook <input checked="" type="radio"/> <input type="radio"/> On Hook <input type="radio"/>  Off Hook  On Hook

Option Menu #: 23

### 5-23.6 Remote Terminal (RT), Single Party Mode

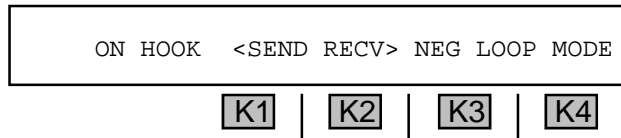
If in RT, **SINGLE** party mode, the display reads:



1. Use the **Up/Down Arrow** keys to scroll through the customer states: **UNEQUIPPED**, **ON-HOOK**, or **OFF-HOOK**.
2. Press **K1** or **K2** to **SEND** the selected customer state. The cursor will flash.
3. Press **K1** or **K2** to discontinue sending; the cursor will cease flashing. The receiver will display all valid commands as they are received. (Refer to **Section 5-23.1 Central Office Terminal (COT), Single Party Mode.**)

### 5-23.7 Remote Terminal (RT), Coin Mode

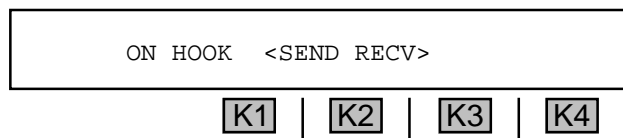
If in RT, **COIN** mode, the display reads:



1. Use the **Up/Down Arrow** keys to scroll through the customer states: **UNEQUIPPED**, **ON-HOOK**, or **OFF-HOOK**.
2. Press **K1** or **K2** to send the selected customer state. The cursor will flash.
3. Press **K1** or **K2** to discontinue sending. The cursor will cease flashing. The receiver will display all valid commands as they are received. (For information on Central Office Terminal (COT) mode, refer to **Section 5-23.1 Central Office Terminal (COT), Single Party Mode.**)

### 5-23.8 Remote Terminal (RT), UVG, Ground Start Mode

If in RT, **UVG, GROUND START** mode, the display reads:



1. Use the **Up/Down Arrow** keys to scroll through the customer states: **UNEQUIPPED**, **ON-HOOK**, **RING GROUND**, or **OFF-HOOK**.

## Section V Option Menu Numbers

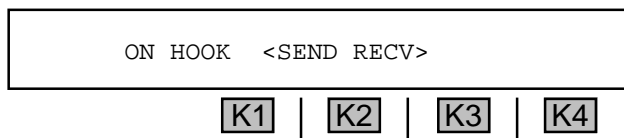
---

2. Press **K1** or **K2** to **SEND** the selected customer state. The cursor will flash.
3. Press **K1** or **K2** to discontinue sending; the cursor will cease flashing. The receiver will constantly display all valid commands as they are received. (Refer to **Section 5-23.1 Central Office Terminal (COT), Single Party Mode.**)

### 5-23.9 Remote Terminal (RT), UVG, Loop Start Mode

---

If in **RT**, **UVG**, **LOOP START** mode, the display reads:

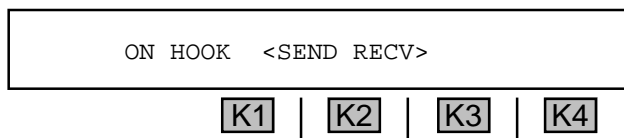


1. Use the **Up/Down Arrow** keys to scroll through the customer states: **UNEQUIPPED**, **ON-HOOK**, **RING GROUND**, or **OFF-HOOK**.
2. Press **K1** or **K2** to **SEND** the selected customer state. The cursor will flash.
3. Press **K1** or **K2** to discontinue sending; the cursor will cease flashing. The receiver will display all valid commands as they are received. (Refer to **Section 5-23.1 Central Office Terminal (COT), Single Party Mode.**)

### 5-23.10 Remote Terminal (RT), DID Mode

---

If in **RT**, **DID** (Direct Inward Dial) mode, the display reads:



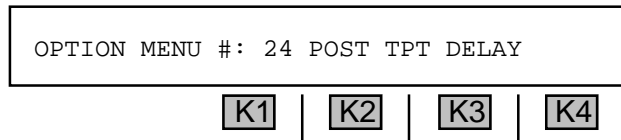
1. Use the **Up/Down Arrow** keys to scroll through the customer states: **NORMAL BATT** (battery) or **REVERS BATT**.
2. Press **K1** or **K2** to send the selected customer state. The cursor will flash.
3. Press **K1** or **K2** to discontinue sending; the cursor will cease flashing. The receiver will display all valid commands as they are received. (For information on Central Office Terminal mode, see **Section 5-23.1, Central Office Terminal (COT), Single Party Mode.**)

5-24 OPTION MENU #: 24 POST TPT DELAY

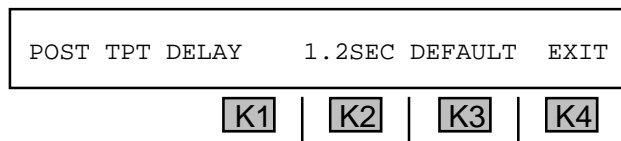
**OPTION MENU #: 24 POST TPT DELAY** is available only when *Purchase Option 935AT-110 Voice Circuit Test Package* is installed. This option allows specification of the amount of time the **935AT** pauses between detecting the TPT from a 105-type responder and sending command MF digits. The time setting affects **OPTION MENU #: 26 ROTL RESPONDER** and **OPTION MENU #2: SEND DIGITS** if the call sequence specifies termination on a 105 test line.

To set the **TPT delay**:

1. Press the **Option Menu** function key.
2. Use the **Up/Down Arrow** keys to scroll through the option menus, **OR** select **24** using the **numeric keypad** and press the **Option Menu** function key. The display reads:



3. Press **ENT** or any softkey (**K1-K4**) to activate your selection. The display reads:



4. Use the **numeric keypad** to change the delay.

- A valid **delay** is between **0.1 SEC** and **99.9 SEC**. The default is **1.2 SEC**. (Pressing **K3** accepts the default value.)

5. Press **ENT** to accept the value.
6. Press **K4** under **EXIT** to return to the main display.

## Section V Option Menu Numbers

---

### 5-25 OPTION MENU #: 25 FAR END RESPONDER

---

**OPTION MENU #: 25 FAR END RESPONDER** is available only when *Purchase Option 935AT-110 Voice Circuit Test Package* is installed. It enables the **935AT** to be configured as a Type 105 Far End Responder and controlled by any CAROT compatible ROTL. The **935AT** can also provide this function directly on a T1 PCM channel. The **935AT** can measure Loss, Noise, Noise with Tone, Gain-Slope, and Return Loss.

To use the **935AT** as a **far-end responder**:

1. Select a trunk type. (Refer to **Section 3-2.1, Trunk Type Function Key** and **Section 4, PCM Operation** for the correct Trunk Type setup in Responder mode.)
2. Connect the **935AT** to the circuit.
3. Press the **Option Menu** function key.
4. Use the **Up/Down Arrow** keys to scroll through the option menus, **OR** select **25** using the **numeric keypad** and press the **Option Menu** function key. The display reads:

OPTION MENU #: 25 FAR END RESPONDER

**K1** | **K2** | **K3** | **K4**

5. Press **ENT** or any softkey (**K1-K4**) to activate your selection. The display reads:

ENABLE MANUAL SEQUENCE?      ON      OFF

**K1** | **K2** | **K3** | **K4**

Press **K3** to turn the manual sequence on, but generally the manual sequence is normally **OFF**.

6. Press **K4** to continue with the setup. The **935AT** always functions in the automatic sequence mode. Manual sequence provides a means for performing single direction tests and is most useful for **PBX** testing.

#### 5-25.1 Setting the TLP and Enabling Manual Sequence

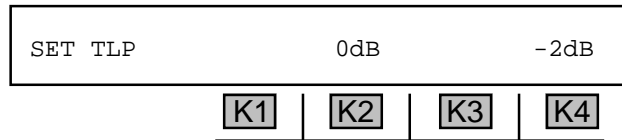
---

**TLP** is a point on a circuit where the transmission level has been specified, providing a reference point to compare the transmission levels at other points on the circuit. **A 0 dB TLP** is standard.

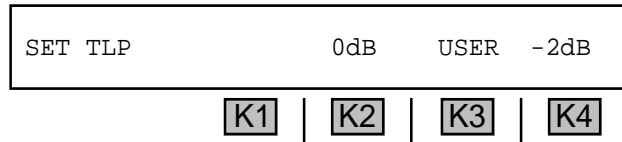
To set the **TLP** and enable **manual sequence**:

1. Press **K3** under **ON** **OR** **K4** under **OFF** from the **ENABLE MANUAL SEQUENCE** display.

If you are in **PCM** mode, the display reads:



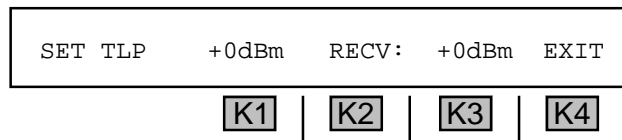
If you are in **analog** mode, the display reads:



2. Press **K1** to advance to the next display without changing any parameters; press **K2** to select 0 dB; press **K3** under **USER** ( in **analog** mode) if you need to set a Send or Receive TLP value other than the standard 0 dB or -2 dB values; or press **K4** to select -2 dB TLP.

If you select a 0 dB or -2 dB TLP, you will be advanced to step 6.

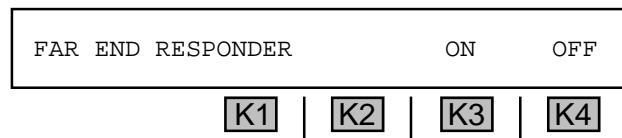
If you press **K3** to select a nonstandard TLP, the display reads:



3. Press **K1** to change the **SEND TLP** OR **K3** to change the **RECV TLP**.
4. Use the **numeric keypad** to enter the desired TLP.

- A valid **SEND TLP** is between -25 dBm and +7 dBm.
- A valid **RECV TLP** is between -16 dBm and +7 dBm.

5. Press **K4** to complete your selection and **EXIT**. The display reads:



6. Press **K3** to enable the Far End Responder. A cursor will appear over the **ON** indication. The **935AT** is now acting as a Type 105 Responder waiting to be accessed. The above display appears regardless of whether or not the **935AT** is in manual sequence mode.

## Section V Option Menu Numbers

---

When accessed by ringing or far-end seizure, the **935AT** goes off-hook and responds with a **2225 Hz** test progress tone (TPT). The **935AT** then waits for **MF** commands and performs the corresponding Type 105 tests. The **935AT** will continue in this mode until one of the following occurs:

- It is released by the calling party via an **MF** “release” command.
- The calling party goes on-hook (see following notes).
- No **MF** command is received for **20** seconds (**935AT** defaults to Manual mode if selected).
- The operator selects **OFF** or discontinues testing in any way.

When the **935AT** is released, or the calling party goes on-hook, the **935AT** goes on-hook for one second and then awaits seizure or ringing. If the **935AT** is allowed to time out (**20** seconds without an **MF** command), it will either go on-hook, or initiate the manual test sequence (if selected).

If the **935AT** is on a loop trunk simulating the subscriber (providing **CONTACT** rather than **BATTERY**), it will expect the far end to remain on-hook, and will not treat this as a release condition.

For **PBX** testing, the manual mode sequence is most useful. If the manual mode has been selected, the responder is allowed to time out (no **MF** command is sent) for **20** seconds or more. The **935AT** then provides the manual trunk test tone sequence shown below:

1. 9 seconds of 1004 Hz tone at -16 dBm0.
2. 1 second of quiet termination.
3. 9 seconds of 404 Hz tone at -16 dBm0.
4. 1 second of quiet termination.
5. 9 seconds of 2804 Hz tone at -16 dBm0.
6. 30 seconds of quiet termination.
7. Short burst of TPT (2225 Hz) signaling end of sequence.
8. On-hook.

If the manual test sequence is not enabled, the **935AT** will return to the on-hook state after a **20** second time out.

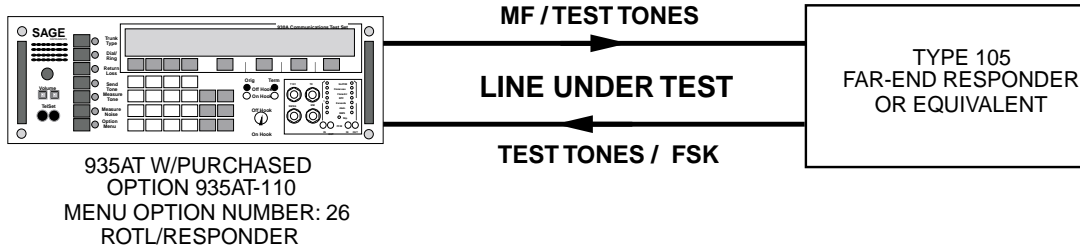
If the **935AT** is in dry circuit (no signaling), it will answer the **DTMF** string **7243**.

7. Press the **Option Menu** function key to exit this option.



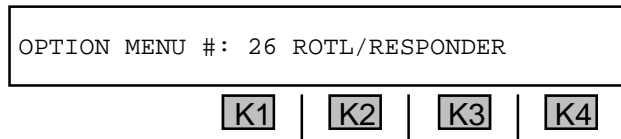
5-26 OPTION MENU #: 26 ROTL/RESPONDER

**OPTION MENU #: 26 ROTL/RESPONDER** is available only when *Purchase Option 935AT-110 Voice Circuit Test Package* is installed. This feature enables the **935AT** to perform the functions of a ROTL/near-end responder, and access a 105 far-end responder and supply the MF signaling necessary to initiate Loss, Gain/Slope, C-message Noise, Noise with Tone, and Return Loss measurements. A typical connection is shown below:

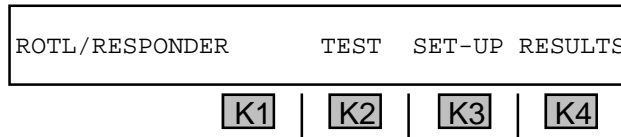


To set up the **935AT** as a **ROTL/near-end responder**:

1. Press the **Option Menu** function key.
2. Use the **Up/Down Arrow** keys to scroll through the option menus, **OR** select **26** using the **numeric keypad** and press the **Option Menu** function key. The display reads:



3. Press **ENT** or any softkey (**K1-K4**) to activate your selection. The display reads:



5-26.1 Setting the TLP

**TLP** is a point on a circuit where the transmission level has been specified, providing a reference point to compare the transmission levels at other points on the circuit. A 0 dB TLP is standard.

To set the **TLP**:

1. Press **K3** under **SET-UP**.

## Section V Option Menu Numbers

---

The display reads:

SET TLP	0dB	USER	-2dB
<b>K1</b>	<b>K2</b>	<b>K3</b>	<b>K4</b>

2. Press **K1** to advance to the next display without changing any parameters; press **K2** to select 0 dB; press **K3** under **USER** if you need to set a Send or Receive TLP value other than the standard 0 dB or -2 dB values; or press **K4** to select -2 dB TLP.

If you select a 0 dB or -2 dB TLP, you will be advanced to **Section 5-26.2**.

If you press **K3** to select a nonstandard TLP, the display reads:

SEND:	+0dB	RECV:	+0dB	EXIT
<b>K1</b>	<b>K2</b>	<b>K3</b>	<b>K4</b>	

3. Press **K1** to change the **SEND TLP** OR **K3** to change the **RECV TLP**.
4. Use the **numeric keypad** to enter a new TLP.

- A valid **SEND TLP** is between -25 dBm and +7 dBm in analog, and between -16 dBm and +7 dBm in PCM.
- A valid **RECV TLP** is between -16 dBm and +7 dBm and between -16 dBm and +7 dBm in PCM.

5. Press **ENT** or any softkey (**K1-K2**) to complete the selection.
6. Press **K4** under **EXIT**.

### 5-26.2 Tests

---

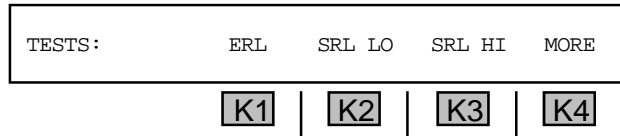
To select a **test**:

1. Press **K2** under **TEST** from the **ROTL/RESPONDER** display. The display reads:

TESTS:	LOSS	GAIN/SLOPE	NOISE	MORE
<b>K1</b>	<b>K2</b>	<b>K3</b>	<b>K4</b>	

2. Press the softkey directly beneath a test to deselect or re-select it. A cursor will appear over each of your selections.

- Press **K4** under **MORE** to advance to the next series of tests:



- Select any or all of the return loss measurements by pressing their associated softkeys. Press **K1** under **ERL** for Echo Return Loss, **K2** under **SRL LO** for Singing Return Loss-Low, and **K3** under **SRL HI** for Singing Return Loss-High. A cursor appears over each selection.

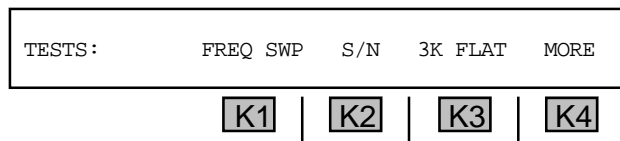
### 5-26.2.1 Extended 105 Responder Tests

---

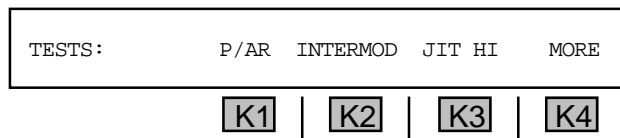
The following tests are available only if the far-end is an Extended 105 (105E) Responder or another **935AT**.

To select **extended responder tests**:

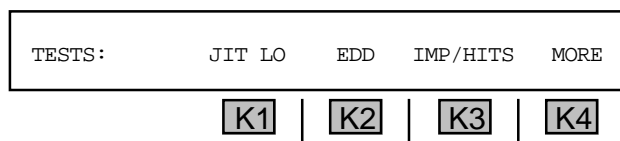
- Press **K4** under **MORE** from the return loss display. The display reads:



- Select any or all of the measurements by pressing their associated softkeys. A cursor appears over each selection.
- Press **K4** under **MORE** to advance to the next display:



- Press **K1** through **K4** to select any or all of the measurements by pressing their associated softkeys. **P/AR**, **intermodulation distortion**, and **jitter high** are available when *Purchase Option 935AT-100* is installed. A cursor appears over each selection.
- Press **K4** under **MORE**. The display reads:

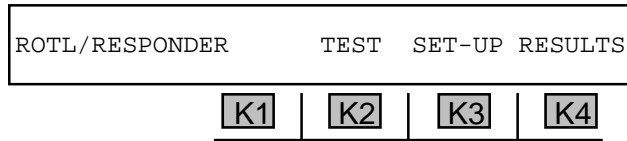


- Select any or all of the measurements by pressing their associated softkeys **jitter lo**, **EDD**, and **impulse noise/hits** requires *Purchase Option 935AT-100*. A cursor appears over each selection.

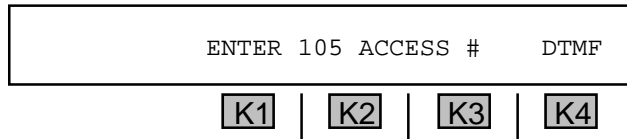
## Section V Option Menu Numbers

---

7. Press **K4** under **MORE** to return to the main **SET-UP** display.



8. Place the hookswitch in the **On Hook** position.
9. Press **K2** under **TEST**. The display reads:



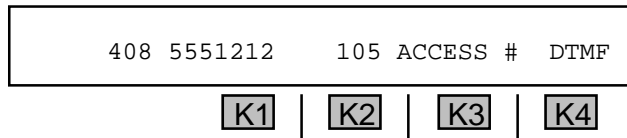
If a number had been previously entered here or in Dial/Ring, it will appear instead of the message: **ENTER 105 ACCESS #**. You can clear the number by pressing **CLR**.

10. Go **off hook** if you are connected to a **105 Testline**.

After 60 seconds, or if you press **K1**, you will be returned to the main **SET-UP** display.

11. Press **K2**, you will initiate another test.
12. Press **K3** to return to the **SET TLP** display. You may scroll through the options again or press **Option Menu** function key to exit back to the main **SET-UP** display.
13. Press **K4** to select the appropriate type of signaling. The digit sequence may be **DP**, **MF** or **DTMF**.
14. Use the **numeric keypad** to enter the phone number of the far end test line.

*for example:*



15. Place the front panel hookswitch in the **Off Hook** position to seize the line and send the call.

5-26.3 Results

To quickly scan test results:

1. Press **K4** under **RESULTS** from the **ROTL/RESPONDER** display.

If no tests are made before selecting **RESULTS**, the display reads: **NO RESULTS 00:00**.

If tests were made, the test results, test duration, and time will be displayed briefly. The **935AT** sequences through 5 different results displays and shows them briefly. The results are also stored in battery-backed CMOS RAM. If a printer is connected, the test results will be printed out as they occur. (Refer to **Section 6, Remote Control Operation** for more information).

*for example:*

CALL COMPLETION TIME		7.4SEC	
K1	K2	K3	K4

LOSS:	NEAR	-7.6dB	FAR	-7.7dB
K1	K2	K3	K4	

NOISE:	NEAR	14dBrn	FAR	15dBrn
K1	K2	K3	K4	

NOISE/TONE:	NEAR	27dBrn	FAR	34dBrn
K1	K2	K3	K4	

RLOSS ERL:	NEAR	37dBrn	FAR	29dBrn
K1	K2	K3	K4	

The **NEAR** results equate to Far-to-Near results given by CAROT. Similarly, the **FAR** results equate to the near-to-far results.

Once the sequence of tests has been completed the **935AT** releases the far-end responder. When complete, the **935AT** returns to the main display.

2. Press any softkey (**K1-K4**) to return to the previous display.

## Section V Option Menu Numbers

---

To **recall and review the results** of the tests more slowly:

1. Press **K4** under **RESULTS**. The **935AT** will recall the stored results of the previous test sequence.
2. Use the **Up Arrow** key or any softkey (**K1-K4**) to scroll up through the various test results.
3. Use the **Down Arrow** key to go backwards through the results.
4. Press the **Right/Left Arrow** keys to return to the beginning of the test results. You will be taken to the first test result after **CALL COMPLETION TIME**.
5. Press the **Option Menu** function key to exit from the results option.

Return Loss testing is not standard in all far-end responders. A “failed” response from the **935AT** means the far-end does not have Return Loss capability. Press the **Option Menu** function key to return to the main menu and begin testing toward standard responders. If you are testing toward a Sage Instruments **356E** Far End Responder or another **935AT**, press **K4** under **MORE** to select additional tests in the **SET-UP** display.

The standard code 105 transmission tests which can be performed by the **935AT** are briefly described below:

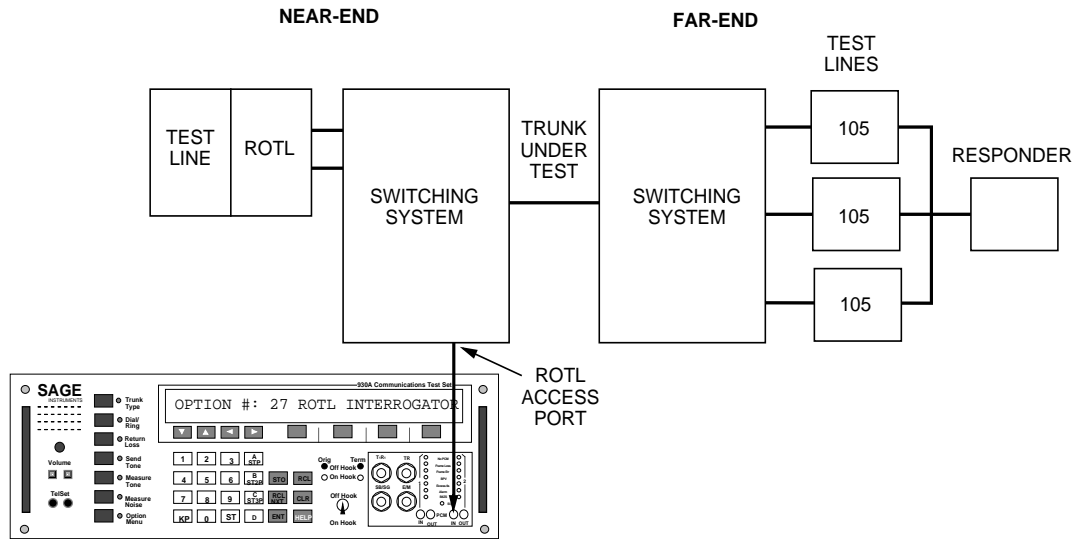
- **LOSS** tests the two-way loss at 1004 Hz, 0 dBm.
- **GAIN/SLOPE** tests the two-way loss at 404 Hz, 1004 Hz, and 2804 Hz. All tone levels are at -16 dBm.
- **NOISE** tests C-Message noise in both directions and tests two-way C-Notch noise using a -16 dBm, 1004 Hz holding tone.
- **ERL, SRL-LO** and **SRL-HI** tests the two-way return loss for each of the three types.

The enhanced responder transmission tests also include the following:

- **FREQ SWP** tests two-way attenuation distortion. (Set in **OPTION MENU #: 10**)
- **S/N** (Signal to Noise Ratio) tests two-way signal-to-noise ratio.
- **3K FLAT** tests 3 kHz flat-weighted noise in both directions.
- **P/AR** tests Peak-To-Average ratio in both directions.
- **INTERMOD** tests two-way 4-Tone Intermodulation Distortion.
- **JIT HI** tests phase and amplitude jitter in 20-300 Hz band in both directions.
- **JIT LO** tests phase and amplitude jitter in 4-300 Hz band in both directions.
- **EDD** tests Forward and Return Reference Envelope Delay. (Set in **OPTION MENU #: 19**)
- **IMP/HITS** tests three-level Impulse Noise, Phase Hits, Gain Hits, and Dropouts in both directions. Test length and other parameters are user selectable. (Set in **OPTION MENU #: 11**)

5-27 OPTION MENU #: 27 ROTL INTERROGATOR

**OPTION MENU #: 27 ROTL INTERROGATOR** is available only when *Purchase Option 935AT-110, Voice Circuit Test Package* is installed. This option lets the **935AT** command a **ROTL** from a **ROTL** access port or over a dial-up line. The **935AT** supports two-way transmission testing to type 105 test lines and one-way transmission testing to type 100 and 102 test lines. Operational Balance and Long Term (**BALT**) tests can also be performed, but support for these tests is limited to the return of audible tones to the operator. A typical test line arrangement showing the **935AT** connected to the near end switch **ROTL** access port is shown below.

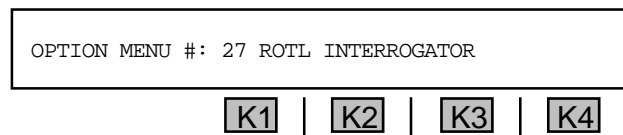


**Figure 5-27.1**  
Interrogator Connected at ROTL Access Port

Since the **ROTL** access port is usually tied up by the **CAROT** controller, the **935AT** can gain test access over any dial-up line, or **T1 PCM** channel at the **DSX**, and interrogate the **ROTL** from there.

To set up the **935AT** to command a **ROTL**:

1. Set the **935AT** to the correct trunk type. (The trunk type the **935AT** is using to connect to the **ROTL**, not the type that the **ROTL** will be testing.) Connect the **935AT** to either the **ROTL** access port, the dial-up line, or the **DSX** (select the trunk type for the connection between the **935AT** and the **ROTL**, not the line under test).
2. Press the **Option Menu** function key.
3. Use the **Up/Down Arrow** keys to scroll through the option menus, **OR** select **27** using the **numeric keypad** and press the **Option Menu** function key. The display reads:

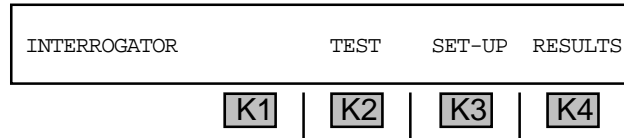


Option Menu #: 27

## Section V Option Menu Numbers

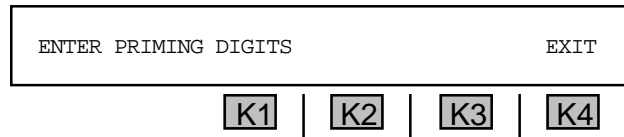
---

4. Press **ENT** or any softkey (**K1-K4**) to activate your selection. The display reads:



5. Place the **hookswitch** in the **On Hook** position.
6. Press **K3** under **SET-UP**.

If no priming digits have been entered, the display will prompt you with the following display:



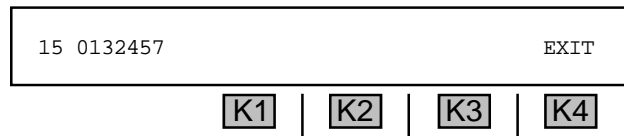
If priming digits had previously been entered, the last string of priming digits will be displayed. If an unwanted string of digits is present, they can be removed by pressing the **CLR** key.

7. Use the **numeric keypad** to enter new **ROTL** priming digits. **ROTL** priming digits are always **MF** digits. The **935AT** has been set to automatically insert the **KP** and **ST** delimiters. You only have to enter the numerical digits. This is a deviation from the way in which the Dial/Ring function operates.

You can enter up to **30** digits in the **ROTL** priming digits field. These digits consist of the test type (up to **3** digits long), the trunk identification number (up to **7** digits long) and the far-end test line number (up to **11** digits long). The **935AT** lets you enter blank characters between the groups for readability. These blank characters are inserted by the **Up Arrow** key and have no effect on outpulsing.

**for example:**

A typical **935AT** display of **ROTL** priming digits, with blank spaces inserted to separate the groups, might appear as shown below:

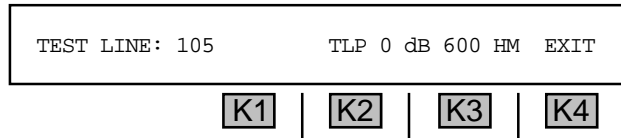


ROTL priming digit sequences vary in accordance with the type and vintage of switching equipment, the type of testing to be performed, the test lines available and their manufacturer.

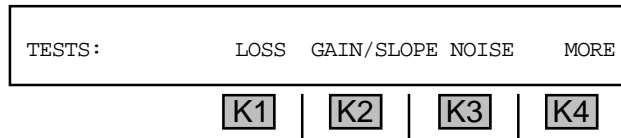


You can edit the string of priming digits to insert or delete individual characters, rather than re-entering the entire string if a mistake or an omission has occurred. The **Left/Right Arrow** keys move the cursor. The **Up Arrow** key inserts a blank space. The **Down Arrow** key deletes an unwanted digit.

8. Press **K4** under **EXIT** when your entry is complete. The display reads:

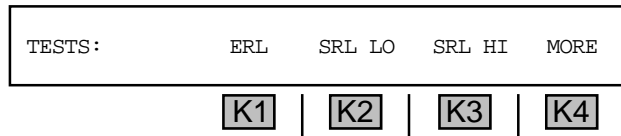


9. Press **K1** to scroll through the **TEST LINE** options of 100, 102, and 105. 105 is the default.
10. Press **K2** to choose between 0 dB and -2 dB TLP. 0 dB is the default.
11. Press **K3** to choose between 600 and 900 Ohms. 600 Ohms is the default.
12. Press **K4** under **EXIT** when your selection is complete. You will advance to the first of two **TESTS** displays:

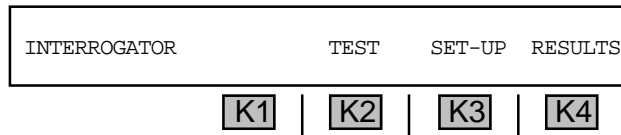


The default parameters show all tests selected.

13. Press the softkey (**K1-K4**) directly beneath a test to select or deselect it.
14. Press **K4** under **MORE** to advance to the next series of tests. The display reads:



15. Press the softkey (**K1-K4**) directly beneath a return loss measurement to select or deselect it.
16. Press **K4** under **MORE** to return to the main display.



## Section V Option Menu Numbers

---

17. Press **K2** under **TEST**. The display reads:

ENTER ROTL DIGITS ACCESS # DTMF			
<b>K1</b>	<b>K2</b>	<b>K3</b>	<b>K4</b>

18. Press **K4** to choose between **DTMF**, **MF** and **DP**.

19. Use the **numeric keypad** to enter the **ROTL** digits.

20. Put the **hookswitch** in the **Off Hook** position. The **935AT** calls the **ROTL** which responds with and audible tone. The display shows a message similar to the following:

15 0132457	SEND		
<b>K1</b>	<b>K2</b>	<b>K3</b>	<b>K4</b>

21. Press **K4** under **SEND** to send the priming digits. The tests will appear on your display. When all the tests are complete, the display reads:

SELECT:	REPEAT	RECYCLE	MANUAL	EXIT
<b>K1</b>	<b>K2</b>	<b>K3</b>	<b>K4</b>	

22. Put the **hookswitch** in the **On Hook** position. (To repeat the previous process, go **Off Hook** again and press **K1** under **REPEAT** .)

23. Press **K2** under **RECYCLE** to return to the priming digits display. At this point you may enter new priming digits.

24. Put the hookswitch in the **Off Hook position** and wait for the tone.

25. Press **K4** under **SEND** and the process will repeat.

26. Press **K3** under **MANUAL** to perform each test one at a time. The display reads:

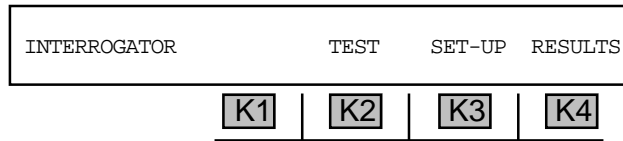
SELECT:	LOSS	TEST	EXIT
<b>K1</b>	<b>K2</b>	<b>K3</b>	<b>K4</b>

27. Press **K2** under **LOSS** to scroll through the different tests available.

28. Press **K3** under **TEST** when you are ready to perform that individual test.

29. Press **K4** under **EXIT** when testing is complete.

30. Press **K4** under **EXIT** again to return to the main display.



31. Press **K4** under **RESULTS** to see the results of your tests. In **PRINTER** remote mode, the results of each test will be sent to the printer as they occur. In **COMPUTER** remote mode, a bell will be sent to the computer at the conclusion of each test. The test results can be read from the display at that time. (Refer to **Section 6, Remote Control Operation** for more information.)

**OPTION MENU #: 3 REMOTE CONTROL** will tell you what mode you are in: **TERMINAL**, **MASTER**, **SLAVE**, **ATR**, **COMPUTER**, **PRINTER**, or **OFF** (not in remote control).

The format of the possible results is:

LOSS:	NEAR	+nn.n	dB	FAR	+nn.n	dB
SLOPE 404:	NEAR	+nn.n	dB	FAR	+nn.n	dB
SLOPE 1004:	NEAR	+nn.n	dB	FAR	+nn.n	dB
SLOPE 2804:	NEAR	+nn.n	dB	FAR	+nn.n	dB
NOISE:	NEAR	nn	dBrn	FAR	nn	dBrn
NOISE/TONE:	NEAR	nn	dBrn	FAR	nn	dBrn
RLOSS ERL:	NEAR	nn	dB	FAR	nn	dB
RLOSS SRL:	NEAR	nn	dB	FAR	nn	dB
RLOSS SRH:	NEAR	nn	dB	FAR	nn	dB

The **NEAR** measurement is the far-to-near measurement and the **FAR** measurement is the near-to-far measurement.

32. Press the **Option Menu** function key to exit this option.

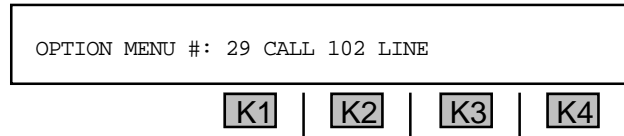
## Section V Option Menu Numbers

### 5-29 OPTION MENU #: 29 CALL 102 LINE

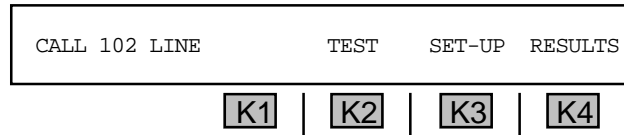
**OPTION MENU #: 29 CALL 102 LINE** is available only when *Purchase Option 935AT-110, Voice Circuit Test Package* is installed. This feature provides easy access to type 102 test lines, commonly known as milliwatt lines. These are dial-up test lines that return a nominal 1004 Hz signal at 0 dBm.

To gain access to **type 102 test lines**:

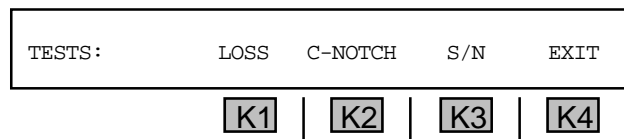
1. Connect the **935AT** to the trunk under test and select the correct trunk type using the **Trunk Type** function key.
2. Press the **Option Menu** function key.
3. Press the **Up/Down Arrow** keys to scroll through the option menus, **OR** select **29** using the **numeric keypad**. The display reads:



4. Press **ENT** or any softkey (**K1-K4**) to activate your selection. The display reads:



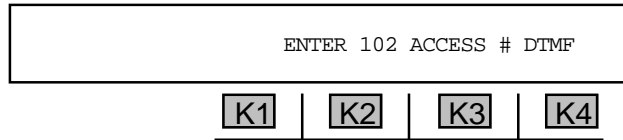
5. Press **K3** under **SET-UP** if you have not previously setup a test. The display reads:



6. Press the softkey (**K1-K4**) beneath a test to select or deselect it. **LOSS** tests are performed at **1004 Hz**. **C-NOTCH** measures C-Notch noise. **S/N** measures a **1004 Hz** signal-to-noise ratio. The default parameters will show all tests to be selected.
7. Press **K4** under **EXIT** to return to the main display.

In **COMPUTER** remote mode (as setup in **OPTION MENU # 3: REMOTE CONTROL**), all previous selections will be cleared when **K3** under **SET-UP** is pressed. Send an ASCII **J** to select **LOSS**, an ASCII **K** to select **C-NOTCH**, and an ASCII **L** to select **S/N**. When all the selections are made, press **K4** under **EXIT**. Your setup will be retained in battery-backed CMOS RAM. You will not need to use the setup function again unless you wish to change the setup.

8. Toggle the **hookswitch** to the **On Hook** position. If the **935AT** is already **Off Hook** when you press **K2** under **TEST**, it will send any displayed digits immediately.
9. Press **K2** under **TEST** when you are ready to begin testing. You will see a display similar to:



The number most recently entered in the **DIAL/RING** mode will usually be displayed in place of the word **ENTER**.

10. Press the **CLR** key to remove any previous entry and return to a display similar to the one above.
11. Press **K4** under **MF**, **DTMF**, or **DP**, depending on the mode selected, to change the outpulsing format to the type required for your circuit. This will also clear any old numbers.
12. Use the **numeric keypad** to enter the access number of the far-end transponder.
13. Go off-hook with the front panel hookswitch to begin testing. The **935AT** will seize the line, send any digits you have entered in the window, and expect the responder at the far-end to answer the call. If no number has been entered in the window, no digits will be sent.

### Printer Remote Mode

If you are in **printer remote mode** (as setup in **OPTION MENU #: 3 REMOTE CONTROL**), the **935AT** will send a time and date stamp and the current access number to the printer to identify the test. (Refer to **Section 6, Remote Control Operation** for more information.)

After it has sent the displayed digits, the **935AT** will look for a **1004 Hz** tone from the transponder. If it does not receive the tone within **60** seconds, or if it detects busy, reorder, dial tone or a tone other than **1004 Hz** (less than **950 Hz** or greater than **1050 Hz**), it will abort the test and send an **ABORT** message to the printer. If the **935AT** successfully detects a **1004 Hz tone**, the results will be sent to the printer.

### Computer Remote Mode

If you are in **computer remote mode**, the **935AT** will send a prompt '>' and a bell when it detects **1004 Hz** or when it aborts a test. It will send an **ABORT** message if unsuccessful, or the **CALL COMPLETION TIME** if successful. It will send another prompt when testing is complete and results can be read on the computer display.

The format of the test results is:

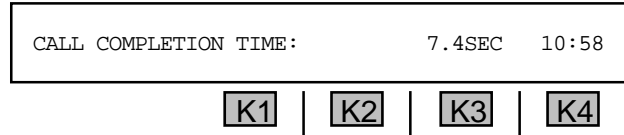
<b>LOSS:</b>	<b>+nn.n dB</b>
<b>C-NOTCH NOISE:</b>	<b>nn dBrnC</b>
<b>SIGNAL/NOISE:</b>	<b>nn dB</b>

## Section V Option Menu Numbers

---

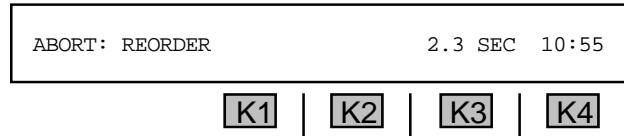
- Return the hookswitch to the **On Hook** position and release the telephone line when you finish testing.
- Press **K4** under **RESULTS** to examine the test results.

If a **1004 Hz** is received from the transponder within seconds, the display shows the call completion time.



If a **1004 Hz** is not received, the display shows an **ABORT** message.

*for example:*



The following is a list of possible **ABORT** messages:

ABORT: BUSY	xx.x SEC
ABORT: REORDER	xx.x SEC
ABORT: DIALTONE	xx.x SEC
ABORT: TONE	xx.x SEC
ABORT: DEAD LINE	xx.x SEC
ABORT: RINGING	xx.x SEC
ABORT: SPEECH?	xx.x SEC

- Press the **Option Menu** function key to return to the main display.

If the call completion time is displayed, you are seeing the time elapsed from the last outputted digit in the 102 access number to the receipt of the **1004 Hz** envelope.

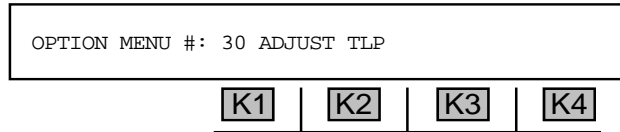
- Press **K1** or the **Up/Down Arrow** keys to scroll through the remaining test results.
- Press the **Option Menu** function key to exit this option.

5-30 OPTION MENU #: 30 ADJUST TLP

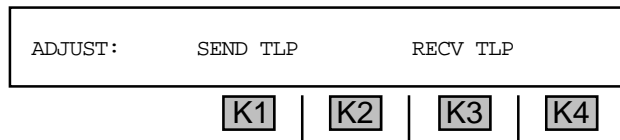
**OPTION MENU #: 30 ADJUST TLP** is a standard feature that allows the manual adjustment of the transmission level point (TLP) compensation of the **935AT**. The Transmit **TLP** affects the level the **935AT** sends. The Receive **TLP** affects the level sensitivity of the **935AT** receiver. This function is normally not used when testing 2-wire analog or **PCM** (T-Carrier) trunks since these are usually a **0 dB TLP**. (Refer to **Section 3-2, Main Function Keys** for information on 4-wire setup.)

To adjust the **TLP**:

1. Press the **Option Menu** function key.
2. Press the **Up/Down Arrow** keys to scroll through the option menus, **OR** select **30** using the **numeric keypad** and press the **Option Menu** function key. The display reads:

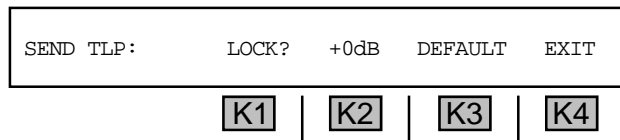


3. Press **ENT** or any softkey (**K1-K4**) to activate your selection. The display reads:



4. Press **K1** under **SEND TLP**. The display shows the current **TLP** setting.

*for example:*



5. Use the **numeric keypad** to enter a new **TLP** (the **D** key will change the value from **+** to **-**).

- A valid **Send TLP** is between **-20dBm** and **+12dBm**. The default is **+0 dB** for **PCM** and **Loop/Ground Start**. If you want the displayed value to remain as the start-up value, press **K1** under **LOCK?** The display will change to **LOCKED**.

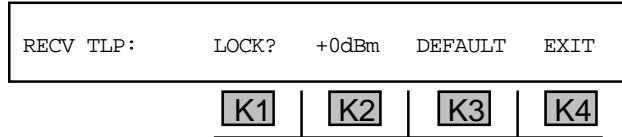
6. Press **ENT** to accept the value.
7. Press **K4** under **EXIT** to return to the **ADJUST** display.

Option Menu #: 30

## Section V Option Menu Numbers

---

8. Press **K3** under **RECV TLP** to change the receive **TLP**. This affects the level sensitivity of the **935AT** digit receiver. The display reads:



9. Use the **numeric keypad** to change the **TLP** (the **D** key will change the value from **+** to **-**).

- A valid **Return TLP** is between **-20dBm** and **+12dBm**. The default is **+0 dB** for **PCM** and **Loop/Ground Start**. If you want the displayed value to remain as the start-up value, press **K1** under **LOCK?** The display will change to **LOCKED**.

10. Press **ENT** to accept the value.

11. Press **K4** under **EXIT** to return the **ADJUST** display.

If you selected **LOCK** for **SEND** or **RECV TLP**, the unit will flash the message: **TLP LOCKED** in **OPTION MENU #: 30** when it is turned on.

12. Press the **Option Menu** function key to exit this function.

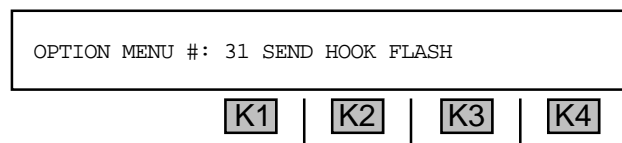


## 5-31 OPTION MENU #: 31 SEND HOOK FLASH

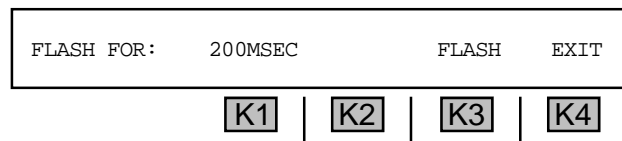
**OPTION MENU #: 31 SEND HOOK FLASH** is a standard feature that enables you to send a hook flash from the **935AT**, and to check a switch's or **PBX**'s flash recognition capability.

To send a **hook flash**:

1. Press the **Option Menu** function key.
2. Use the **Up/Down Arrow** keys to scroll through the option menus, **OR** select **31** using the **numeric keypad** and press the **Option Menu** function key. The display reads:



3. Press **ENT** or any softkey to activate your selection. The display reads:



4. Use the **numeric keypad** to change the flash duration.

- A valid **flash duration** is between **10** and **9999 MSEC**. The default duration is **200 MSEC**.

5. Press **ENT** or any softkey (**K1-K4**) when your value is chosen. Hook flashes less than **50 MSEC** in duration will not be indicated by the front panel supervision LEDs.
6. Press **K3** under **FLASH** to send a hook flash of the displayed duration on the analog trunk or **PCM** channel selected. When **On Hook**, sending a hook flash causes the **935AT** to go off-hook for the prescribed number of milliseconds. When **Off Hook**, sending a hook flash causes the **935AT** to go on-hook during the flash. The **935AT** will continue to send hook flashes when **Off Hook** until you return the hookswitch to the **On Hook** position.
7. Press **K4** under **EXIT**, or press the **Option Menu** function key to exit the option.

**Section V Option Menu Numbers**

---

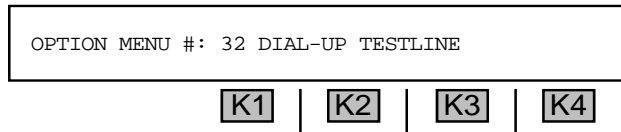
**5-32 OPTION MENU #: 32 DIAL-UP TESTLINE**

---

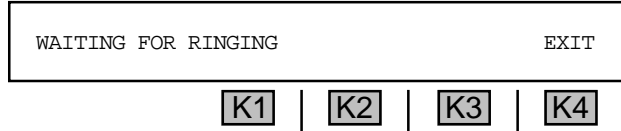
**OPTION MENU #: 32 DIAL-UP TESTLINE** is a standard feature that enables the **935AT** to provide Quiet Termination or send a tone in response to ringing or seizure so that the **935AT** can act as a Type 100 or a Type 102 testline.

To set up the **935AT** as a **Type 100** or **102 testline**:

1. Use the **Send Tone** function to setup the tone to be sent on “Quiet Termination.” If the **Send Tone** function is turned off, the **935AT** will supply Quiet Termination.
2. Press the **Option Menu** function key.
3. Press the **Up/Down Arrow** keys to scroll through the option menus, **OR** select **32** using the **numeric keypad** and press the **Option Menu** function key. The display reads:



4. Press **ENT** or any softkey (**K1-K4**) to activate your selection. The display reads:



5. If the **935AT** is supplying battery or is in **PCM** mode, press **ENT** or any softkey (**K1-K4**) to display the message: **WAITING FOR SEIZURE** or, if the **935AT** is in **CONTACT** mode, the display reads: **WAITING FOR RINGING**.

Entering this **Option Menu** places the **935AT** on-hook where it will remain waiting for line seizure before going off-hook.

If the **935AT** tone generator has been turned **OFF**, the **935AT** will provide Quiet Termination when ringing or seizure is detected.

If you have selected a tone, for example, **1004 Hz** at **0 dBm**, and left the tone generator turned on prior to entering **OPTION MENU #: 32**, then the **935AT** will respond with the **1004 Hz** at **0 dBm** when ringing or seizure is detected. It will remain until seizure is dropped (off-hook), the **Option Menu** function key is pressed, or a time out has occurred.

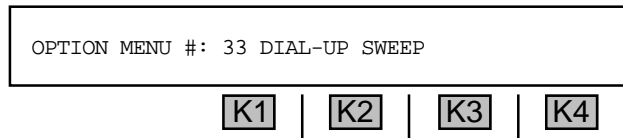
Option Menu #:  
32

5-33 OPTION MENU #: 33 DIAL-UP SWEEP

**OPTION MENU #: 33 DIAL-UP SWEEP** is a standard feature that operates exactly like **OPTION MENU #: 32 DIAL-UP TESTLINE** except that it sends back whatever sweep parameters have been set in **OPTION MENU # 10: FREQUENCY SWEEP**.

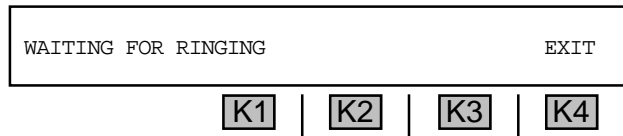
To conduct a **frequency sweep** that sends back the sweep parameters:

1. Set the sweep up using **OPTION MENU #: 10 FREQUENCY SWEEP**. (Refer to **Section 5-10, Option Menu #: 10 Frequency Sweep** for information on this function.)
2. Press the **Option Menu** function key.
3. Use the **Up/Down Arrow** keys to scroll through the option menus, **OR** select **33** using the **numeric keypad** and press the **Option Menu** function key. The display reads:



4. Press **ENT** or any softkey (**K1-K4**) to activate your selection.

If the **935AT** is supplying battery or is in **PCM** mode, the **935AT** will display the message: **WAITING FOR SEIZURE**. If the **935AT** is in **CONTACT** mode. The display reads:



When the **935AT** receives ringing it will send the sweep frequencies back. This will continue until the trunk is disconnected (goes back **On Hook**), you exit this display, or a 5 minute time interval has lapsed during which no off-hook supervision has been supplied.

5. Press **K4** to **EXIT** from this menu and stop any sweep in progress.

**Section V Option Menu Numbers**

---

**5-34 OPTION MENU #: 34 SELECT REPORTS**

---

**OPTION MENU #: 34 SELECT REPORTS** is a standard feature that allows you to select reports for printing or review via computer terminal. (Refer to **Section 6, Remote Control Operation** and **Section 5-3, Option Menu #: 3 Remote Control** for remote control setup).

To **select reports** for printing or review:

1. Press the **Option Menu** function key.
2. Use the **Up/Down Arrow** keys to scroll through the option menus, **OR** select **34** using the **numeric keypad** and press the **Option Menu** function key. The display reads:

OPTION MENU #: 34 SELECT REPORTS			
K1	K2	K3	K4

3. Press **ENT** or any softkey (**K1-K4**) to activate your selection. If you are in **COMPUTER** or **TERMINAL** remote mode, the display reads:

REPORT ERRORS?	YES	NO	
K1	K2	K3	K4

If in **PRINTER** remote mode, the display reads: **PRINT ERRORS?**

4. Press **K3** under **YES** to send the **PCM** formatted error report **OR** press **K4** under **NO** to omit the **PCM** formatted error report. The display reads:

REPORT RECEIVED RECORDS?	YES	NO	
K1	K2	K3	K4

If in **PRINTER** remote mode, the display reads: **PRINT RECEIVED RECORDS?**

5. Press **K3** under **YES** to send calls captured by the digit receiver **OR** press **K4** under **NO** to omit the calls captured by the digit receiver. Selecting **YES** displays the following display. Selecting **NO** skips the following display.

REPORT DIGIT ANALYSIS?	YES	NO	
K1	K2	K3	K4

If in **PRINTER** remote mode, the display reads: **PRINT DIGIT ANALYSIS?**

Option Menu #:  
34

6. Press **K3** under **YES** to send the analysis of the received digits OR press **K4** under **NO** to omit the analysis of the received digits. The display reads:

REPORT WINK TIMING?	YES	NO	
<b>K1</b>	<b>K2</b>	<b>K3</b>	<b>K4</b>

If in **PRINTER** remote mode, the display reads: **PRINT WINK TIMING?**

7. Press **K3** under **YES** to send the report on wink timing measurements OR press **K4** under **NO** To omit wink timing measurements. The display reads:

READY			
<b>K1</b>	<b>K2</b>	<b>K3</b>	<b>K4</b>

A prompt will be sent to the host computer to indicate that the **935AT**'s command buffer is empty and the **935AT** is awaiting instructions.

## Section V Option Menu Numbers

---

### 5-35 OPTION MENU #: 35 DUAL TONE SENDER

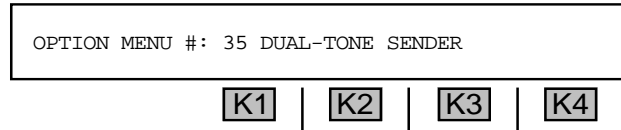
---

**OPTION MENU #: 35 DUAL TONE SENDER** is a standard feature that enables the **935AT** to send any dual tone signal if the two tones fall within the **935AT** frequency range. The **935AT** has three preset signals: **Dial tone**, **Busy** and **Reorder**.

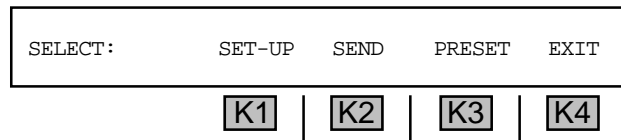
In **Loop Start** or **Ground Start** contact end trunks, the **935AT** must be off hook to send.

To send a **dual tone**:

1. Press the **Option Menu** function key.
2. Press the **Up/Down Arrow** keys to scroll through the option menus, **OR** select **35** using the **numeric keypad** and press the **Option Menu** function key. The display reads:



3. Press **ENT** or any softkey (**K1-K4**) to activate your selection. The display reads:



#### 5-35.1 Setup

---

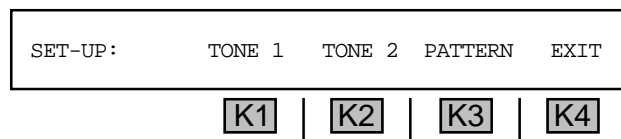
The setup function is used to select a pair of tones that is different from the factory preset tone pairs.

##### 5-35.1.1 Frequency and Level

---

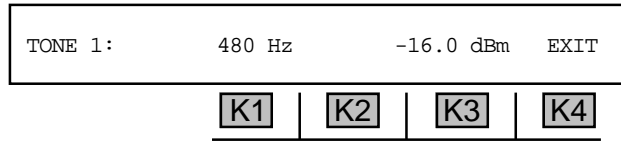
To change the **frequency** and **level** of the signal:

1. Press **K1** from the **SELECT** display. The new display reads:



2. Press **K1** to set the level and frequency of **TONE 1** **OR** press **K2** to set **TONE 2**.

For **TONE 1**, the display reads:



The display for **TONE 2** is the same as for **TONE 1**.

3. Press **K1** to change the frequency of the tone OR press **K3** to change the level.
4. Use the **numeric keypad** to enter a new frequency and level.

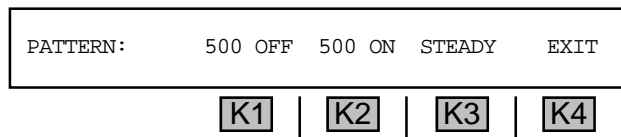
- A valid **frequency** is between 20 Hz and 5000 Hz. In **DIALTONE**, the default values are 350 Hz and for **TONE 1** and 440 Hz for **TONE 2**. In **BUSY** or **REORDER**, the default values are 480 Hz and for **TONE 1** and 620 Hz for **TONE 2**.
- A valid **level** is between +12.0 dBm and -99.9 dBm. In **DIALTONE BUSY** or **REORDER**, the default value is -16.0 dBm for **TONE 1&2**.

5. Press **ENT** or any softkey (**K1-K4**) to complete the selection.
6. Press **K4** to exit back one display.

### 5-35.1.2 Pattern

To change the **timing** or **pattern** in **BUSY** or **REORDER**:

1. Press **K3** under **PATTERN** in the **SETUP** display. The new display reads:



You can change the interval for the tones or send a continuous tone. For example, **BUSY** is sent at 500 milliseconds **OFF** and 500 milliseconds **ON** as shown above. **REORDER** is sent at 250 milliseconds **OFF** and 250 milliseconds **ON**.

2. Press **K1** under **OFF** to change the **OFF** signal OR **K2** to change the **ON** signal.

## Section V Option Menu Numbers

---

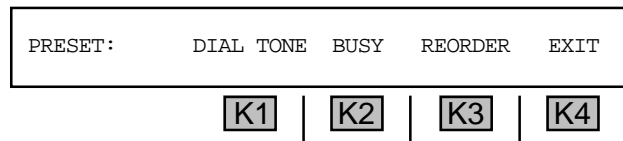
3. Use the **numeric keypad** to enter the desired time interval.
  - A valid **time interval** is between 1 millisecond and **9999 MSEC**.
4. Press **ENT** or any softkey (**K1-K4**) to accept the values.
5. To send a signal continuously, press **K3** under **STEADY**. In this case the **OFF** and **ON** times are blank.
6. Press **K4** twice to exit back to the main display to perform the test.

### 5-35.2 Preset

---

To select and send one of the **935AT**'s standard preset signals:

1. Press **K3** under **PRESET**. The display reads:



2. Press the softkey directly below the tones you want to send. You will be returned to the **SELECT** display.
3. Press **K2** under **SEND**. A flashing cursor will appear over **SEND** while you are transmitting. The tone(s) will be audible through the front panel speaker.

In Loop Start or Ground Start contact end trunks, the **935AT** must be off-hook to send.

4. Press **K2** under **SEND** again or go **On Hook** to stop sending. If testing is complete, press **K4** under **EXIT**.

### 5-35.3 Send

---

To send a dual tone:

1. Go **Off Hook** and press **K2** under **SEND** from the **SELECT** display.
2. Press **K2** under **SEND** again or go **On Hook** to stop sending.
3. Press **K4** under **EXIT** when testing is complete.



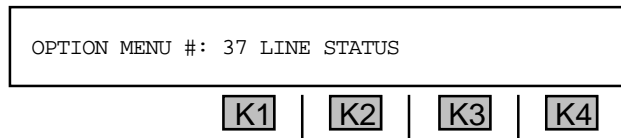
5-37 OPTION MENU #: 37 LINE STATUS

**OPTION MENU #: 37 LINE STATUS** is a standard feature that enables the **935AT** to bridge or terminate on a metallic facility (2W/4W) loop, or a **PCM** channel, and monitor the status of the line in one direction. Typically, the **935AT** analyzes the received audible tones on the line and displays the condition. The following audible tones are analyzed: **Dial Tone, Busy, Reorder, Dead Line, Talking or Speech, and Tone.**

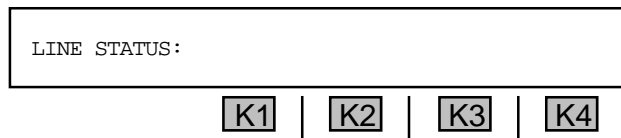
When any of the above conditions occur, the display will be in real time. If the condition changes, it will clear after a timeout and indicate the new condition. This information can be printed or sent to a computer as it occurs. (Refer to **Section 6, Remote Control Operation** and **Section 5-3, Option Menu #: 3, Remote Control** for more information.)

To view the **line status**:

1. Press the **Option Menu** function key.
2. Use the **Up/Down Arrow** keys to scroll through the option menus, **OR** select **37** using the **numeric keypad** and press the **Option Menu** function key. The display reads:



3. Press **ENT** or any softkey (**K1-K4**) to activate your selection. The display reads:



As conditions change on the line, the display status will update.

4. Press the **Option Menu** function key to exit this option.

## Section V Option Menu Numbers

---

### 5-39 OPTION MENU #: 39 REMOTE AUDIO

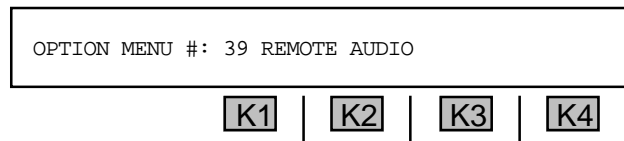
---

**OPTION MENU #: 39 REMOTE AUDIO** is only available when *Purchase Option 935AT-347, Remote Audio* is installed. The Remote Audio option provides remote access to the trunk under test. This is accomplished via a separate dial-up line. This enables troubleshooting and verification from a remote location.

Remote audio access is through a standard modular telephone jack (RJ-11) located on the **935AT** rear panel. Refer to **Section 1-7, DC Rear Panel** for location. The modular jack provides a loop appearance. When the **935AT** is turned on, the remote audio line is placed on-hook. The monitor can be set to answer automatically when it detects ringing.

To gain **remote access** to the trunk under test:

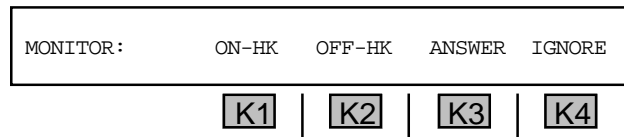
1. Press the **Option Menu** function key.
2. Use the **Up/Down Arrow** keys to scroll through the option menus, **OR** select **39** using the **numeric keypad** and press the **Option Menu** function key. The display reads:



OPTION MENU #: 39 REMOTE AUDIO

K1 | K2 | K3 | K4

3. Press **ENT** or any softkey (**K1-K4**) to activate your selection. The display reads:



MONITOR:      ON-HK    OFF-HK    ANSWER    IGNORE

K1 | K2 | K3 | K4

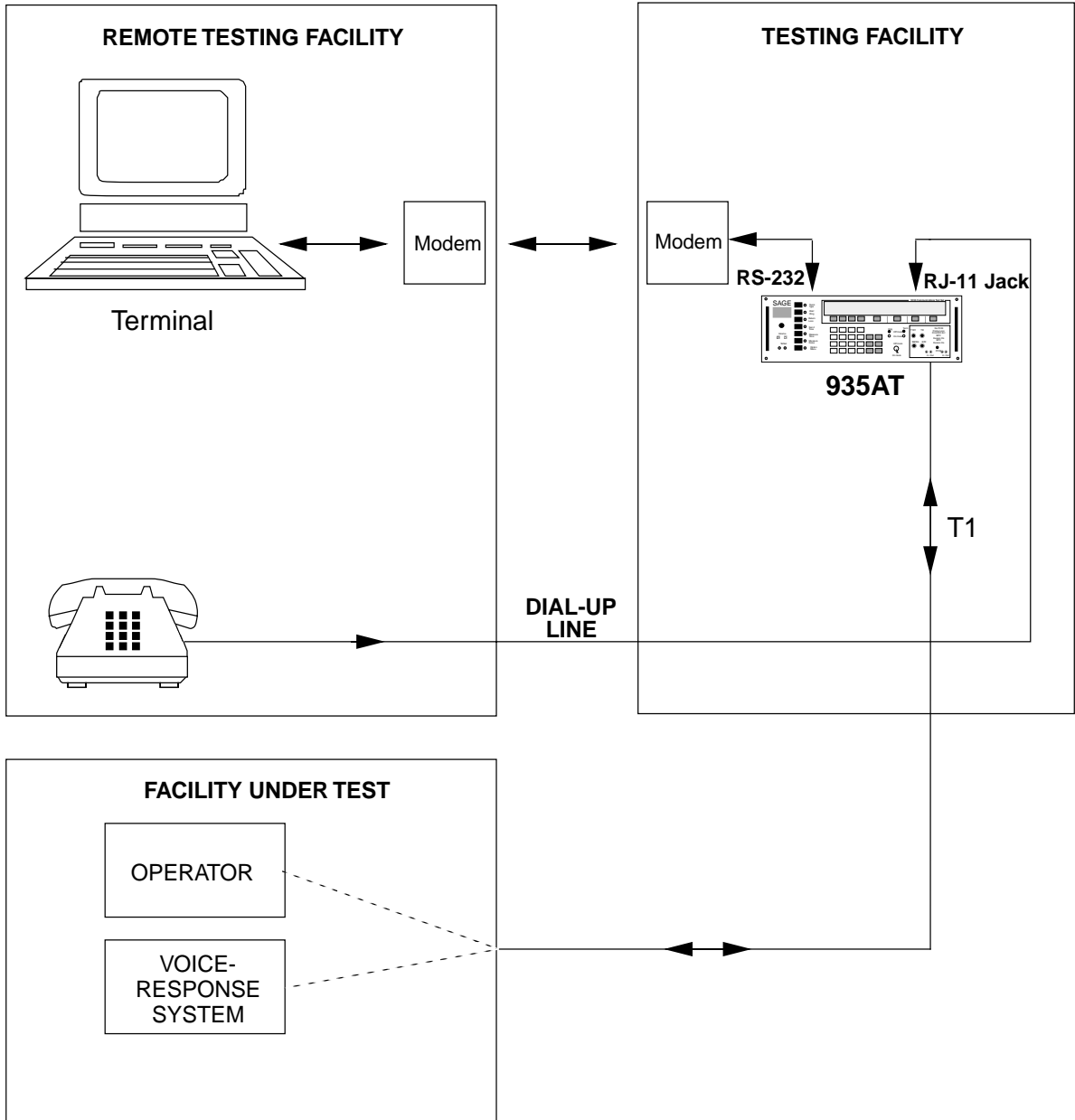
Flashing cursors indicate whether the audio monitor is currently on- or off-hook, and whether it has been programmed to answer or ignore incoming calls.

If the remote line has been set to answer incoming calls, it will respond to and trip ringing by going off-hook.

4. Press **K1** to place the remote line on-hook, **K2** to place the Remote Line off-hook, **K3** to answer incoming calls, or **K4** to ignore incoming calls.
5. Press the **Option Menu** function key to exit.

Remote Audio may be operated remotely by establishing a modem call connection from the control site. (Refer to **Section 5-3, Option Menu #: 3 Remote Control** and **Section 6, Remote Control Operation** for setup information.)

The connection of the 935AT for remote audio operation appears below:



Option Menu #:  
39

Figure 5-39.1  
Remote Audio Operation

**Section V Option Menu Numbers**

**5-40 OPTION MENU #: 40 SEND PCM ALARMS**

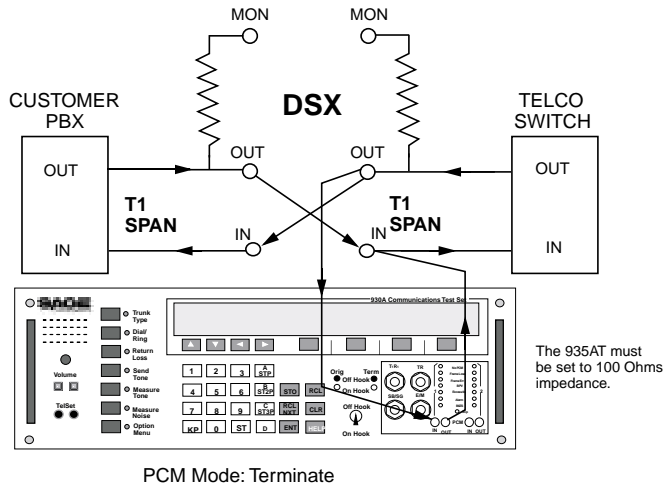
**OPTION MENU #: 40 Send PDM Alarms** is a standard feature. Sending Remote Alarm, Blue Alarm or forcing a Frame Slip is not intended to be done on spans carrying service. They are tests usually performed prior to turning up service on a channel bank or switch to see that their alarm indicators are working. The **935AT** will not allow you to send alarms or slips unless you are in the **TERMINATE** mode (out of service).

To send **PCM** alarms:

1. Set the **935AT** to **PCM TERM** mode under the **Trunk Type** function key.
2. Connect the **935ATs** test cords as shown in **Figure 5-40.1**.

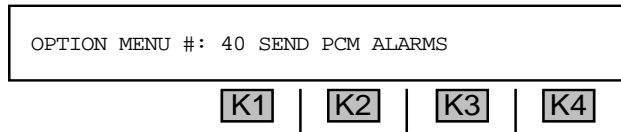
If your circuit is loop-timed, you will not be able to force a frame slip toward the distant end of your circuit.

3. Press the **Option Menu** function key.

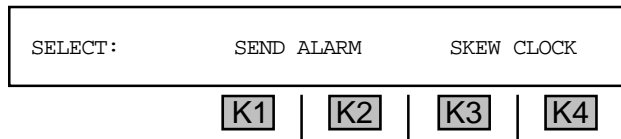


**Figure 5-40.1**  
**Sending Alarms or Forcing Slips From the 935AT**

4. Use the **Up/Down Arrow** keys to scroll through the option menus, **OR** select **40** using the **numeric keypad** and press the **Option Menu** function key. The display reads:



5. Press **ENT** or any softkey (**K1-K4**) to activate your selection. The display reads:

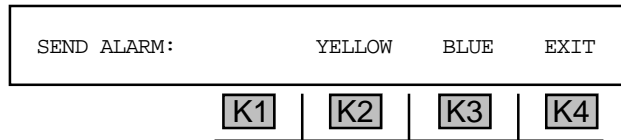


Option Menu #: 40

5-40.1 Send Alarm

To send a **PCM alarm**:

1. Press **K1** or **K2**. The display reads:



2. Press **K2** to send the Remote (**YELLOW**) Alarm **OR** press **K3** to send the unframed All 1s (**BLUE**) Alarm. When you select an alarm, a cursor appears over your selection.

**YELLOW ALARM** --on D4 and SLC-96, bit number 2 is forced to 0 on all 24 channels; on ESF, a special code is sent over the Facility Data Link. A yellow alarm is sent when there is a failed transmit circuit in a DS-1 2-way transmission path.

**BLUE ALARM**--ones are sent in all bits of all time slots on a span. A blue alarm is sent when two consecutive frames have fewer than three zeroes in a data bit stream.

3. Press **K4** to exit from this display and turn the alarm off.

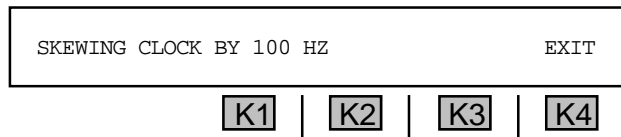
5-40.2 Skew Clock

To skew the **clock**:

1. Make sure that the **935AT** is supplying the clock to the circuit ( **INT CLK** ). (Refer to **Section 3, Front Panel Operation** for trunk type setup.)
2. Press **K3** or **K4** under **SKEW CLOCK** from the main **SELECT** display. If the **935AT** is set to **INT CLK** the normal **1.544 MHz** clock will be offset by **100 Hz**. This is enough to force frame slips to occur if the distant end of the circuit is not Loop-Timed.

If you are not in **TERMINATE** mode or have chosen **LOOP TIME** under **INT CLK** under the **Trunk Type** function key , you will see the message: **CANNOT SKEW WHEN LOOP TIMED** .

If you are in **INTERNAL** clock mode, the display reads:



When skew is set properly and the far-end is not loop-timed, a slip will occur *every 2-3 seconds*.

3. Press **K4** to exit this display and return the **935AT** to the normal clock mode. Slips, if they occur, will be detected while you are in this display and the display will be interrupted momentarily while the slip light flashes. The Slip Counter in **Option Menu #: 43** will also be counting the slips.

**Section V Option Menu Numbers**

**5-41 OPTION MENU #: 41 READ T1 VOLTAGE**

**OPTION MENU #: 41 Read T1 Voltage** is a standard feature that enables you to measure and read the T1 pulse amplitude.

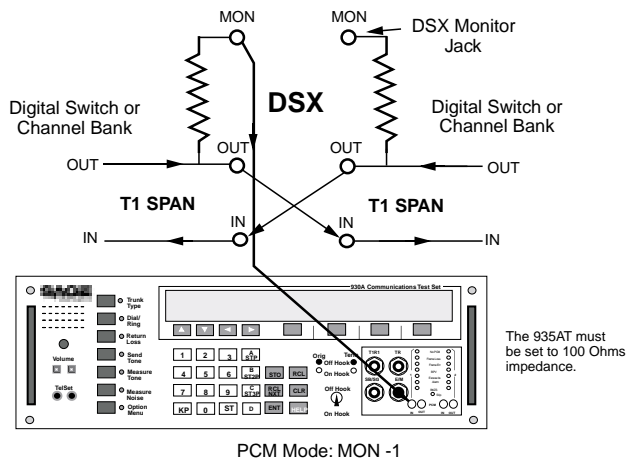
To measure the positive and negative **base-to-peak voltages**:

1. Set a **PCM** trunk type.
2. Connect one, or both, of the **PCM** receivers to the **DSX**.

*for example:*

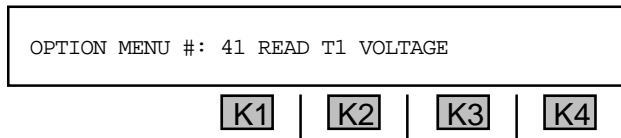
**Figure 5-41.1** shows a **935AT** in the **MON-1** mode connected to the monitor jack on a **DSX**.

At the **DSX** output jacks, expect to see about  $\pm 3.0$  volts base-to-peak. At the monitor jacks, however, expect to see about one tenth the voltage, or roughly  $\pm 0.3$  volts base-to-peak. The reading should not be less than  $\pm 0.2$  volts base-to-peak at the **DSX** monitor jack. If so, this indicates a possible problem in the office. It could be a problem with a CSU, a defective cable, poor LBO equalization, or too long a cable run from the equipment to the **DSX**.



**Figure 5-41.1**  
**Measuring T1 Voltage at the DSX Monitor Jack**

3. Press the **Option Menu** function key.
4. Use the **Up/Down Arrow** keys to scroll through the option menus, **OR** select **41** using the **numeric keypad** and press the **Option Menu** function key. The display reads:



5. Press **ENT** or any softkey (**K1-K4**) to activate your selection. The **935AT** will display its readings as Base-to-Peak voltage.

Option Menu #: 41

*for example:*

A typical reading at the **DSX** output jack might be:

T1 VOLTAGE:	BASE->PEAK	+3.21	-3.18
<b>K1</b>	<b>K2</b>	<b>K3</b>	<b>K4</b>

The positive and negative going peaks are close to each other in terms of absolute value. If they were very different from each other (more than **0.5 V**), or if they were much higher or lower than the nominal **3 V (6.0 peak-to-peak)**, problems may occur.

6. Press any softkey (**K1-K4**) to read the **T1** pulse amplitude in **dBdsx** instead of **voltage**.

*for example:*

T1 PULSE AMPLITUDE:	-18.0	dBdsx	
<b>K1</b>	<b>K2</b>	<b>K3</b>	<b>K4</b>

**3.0** volts base-to-peak is equal to **0.0 dBdsx**. Readings between **-1.0** and **1.0 dBdsx** would be expected at the **DSX** output jacks. Readings of about **-20 dBdsx** would be expected at the **DSX** monitor jacks.

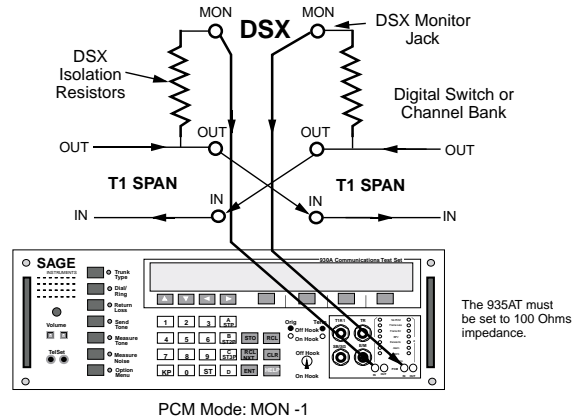
**Section V Option Menu Numbers**

**5-42 OPTION MENU #: 42 T1 WANDER**

**OPTION MENU #: 42 T1 Wander** is a standard feature. T1 Wander, sometimes called Bit Slips, occurs prior to a Frame Slip. This feature indicates whether or not a span may have a slip problem. The **935AT** best performs this test in **MON-1&2** mode to be able to compare the outgoing and incoming clocks. (Refer to **Section 4, PCM Operation** for setup procedures.)

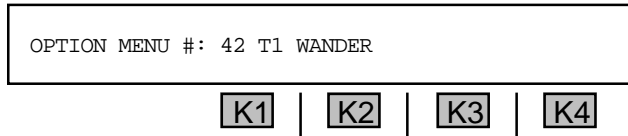
To determine whether a slip problem exists:

1. Connect the test cords as shown in **Figure 5-42**.
2. Press the **Option Menu** function key.



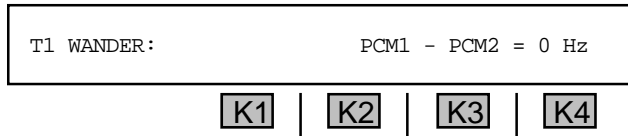
**Figure 5-42.1**  
**935AT Connected for Wander Measurement**

3. Press the **Up/Down Arrow** keys to scroll through the option menus, **OR** select **42** using the **numeric keypad** and press the **Option Menu** function key. The display reads:



4. Press **ENT** or any softkey to activate your selection.

If you are in **MON1&2** or **D&I**, the **935AT** is forced into **EXT CLK** and the display reads:



In this case, the **935AT** compares the clock on **PCM IN 1** with the clock on **PCM IN 2**. Note the sign on the result. If **PCM2** is higher, the sign will be (-).

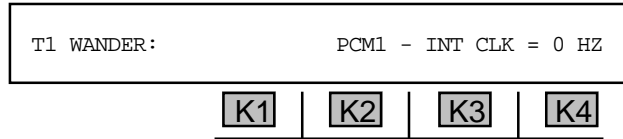
The frequency difference between the two bit streams is called the Bit-Slip rate (gated rate for 1 second). If bit slips occur, the two sides may diverge until a frame slip occurs. (193 Bit-Slips = 1 Frame Slip) This could be in either the + or - direction.

**Option Menu #:  
42**



If a frame slip occurs, you can connect a good clock source to the **935AT** at **PCM 1 IN** and the suspect side of the span to **PCM 2 IN**, and then compare the differences.

If you are in **MON-1** or **TERMINATE** modes, the **935AT** is forced into **INT CLK** and the display reads:



In this case the **935AT** compares the clock on **PCM IN 1** to its own **Internal Clock**. Do not expect **PCM1** to agree with the **Internal Clock**, unless the far-end is Loop-Timed to the **935AT**. The actual value is not significant. Large changes in the readings, however, indicate that the clock in your switch, or the clock in your **935AT**, is wandering and needs to be repaired.

5. Press the **Option Menu** function key to exit this function. If you are in **MON-1** or **TERMINATE** mode, the **935AT** returns to **EXT CLK**.

**Section V Option Menu Numbers**

**5-43 OPTION MENU #: 43 T1 ERROR COUNTERS**

**OPTION MENU #: 43 T1 Error Counters** is a standard feature. With this option, once the **PCM** trunk type has been selected and the **935AT** has been connected to the **T1** span, the **935AT** automatically monitors and counts **BPV ERR**, **BPVR** (Bipolar Violations Rate), **FR** (Frame) **ERRS** (D4 mode only), **CRCS** (ESF mode only), **BIT SLIPS**, **FR SLIP**, **FR LOSS**, **NO PCM**, **EFS** (Error Free Seconds), **%EFS**, **ES** (Errored Seconds), **%ES**, **SES** (Severely Errored Seconds), **%SES**, **FAILED**, **%FAILED**, **AVAIL**, **%AVAIL**, **UNAVAIL**, and **%UNAVAIL**. All measurements are in accordance with **CCITT G.821**. (Refer to **Section 4, PCM Operation** for setup information.)

When a line error occurs, the **935AT** will momentarily interrupt the current display to flash an error message. If you are in a dual direction mode such as **MON-1&2** or **D&I**, the **935AT** will also show you the direction from which the error came.

**5-43.1 Example: MON 1&2 Mode**

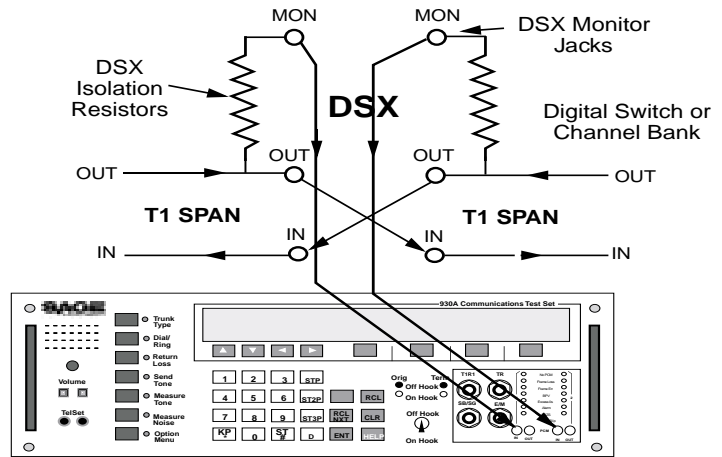
To set up the **T1 Error Counter** function and view errors in **MON-1&2** mode:

Option Menu #: 43

1. Connect the **935AT**'s test cords as shown in **Figure 5-43.1**.

When the **935AT** is in the **MON-1&2** mode, and connected to the **DSX** monitor jacks, it will accumulate errors as they occur.

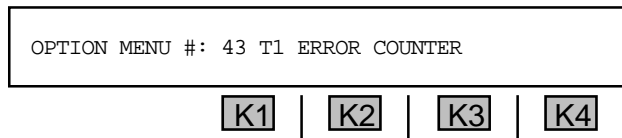
2. Press the **Option Menu** function key.



PCM Mode: MON -1&2

**Figure 5-43.1**  
**Test Cord Connections for Error Monitoring**

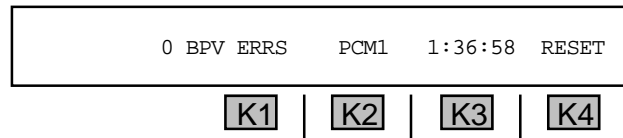
3. Use the **Up/Down Arrow** keys to scroll through the option menus, **OR** select **43** using the **numeric keypad** and press the **Option Menu** function key. The display reads:



4. Press **ENT** or any softkey (**K1-K4**) to activate your selection. The display show the error counts. In order of display, the tests are **BPV ERR**, **BPVR** (Bipolar Violations Rate), **FR** (Frame) **ERRS** (**D4 mode only**), **CRCS** (**ESF mode only**) **BIT SLIPS**, **FR SLIP**, **FR LOSS**, **NO PCM**, **EFS** (Error Free Seconds), **%EFS**, **ES** (Errored Seconds), **%ES**, **SES** (Severely Errored Seconds), **%SES**, **FAILED**, **%FAILED**, **AVAIL**, **%AVAIL**, **UNAVAIL**, and **%UNAVAIL**.

*for example:*

The first display reads:



5. Press **K1** or the **Up/Down Arrow** keys to page through the tests described above.
6. If the **935AT** is in the **MON-1&2** or **D&I** modes, press **K2** to toggle between side **1** and side **2**. The **935AT** has independent counters on each side.

Errors from **ES** and **SES** are based on **Bipolar Violations** and **Frame, FPS**, and **CRC** errors depending on the frame type used.

7. Press the **CLR** key or **K4** under **RESET** to clear all counters.
8. Press the **Option Menu** function key to exit.

**Section V Option Menu Numbers**

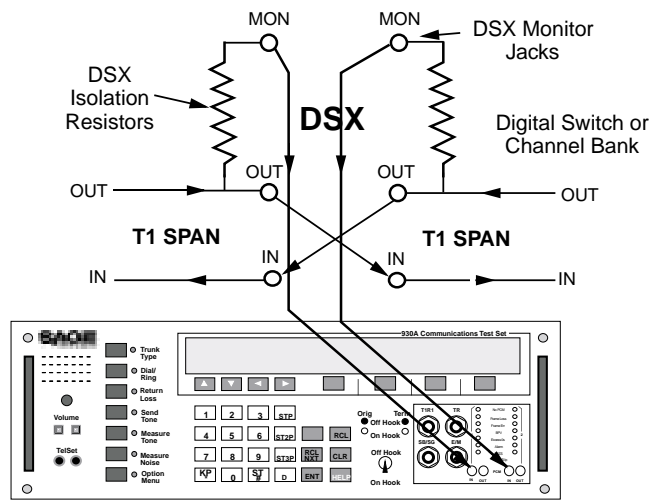
**5-44 OPTION MENU #: 44 T1 ERROR HISTORY**

**OPTION MENU #: 44 T1 Error History** is a standard feature that gives you up to 24 hours of history on the span under test. The tests are **BPV ERR**, **BPVR** (Bipolar Violations Rate), **FR** (Frame) **ERRS**, **BIT SLIP**, **FR SLIP**, **FR LOSS**, **NO PCM**, **EFS** (Error Free Seconds), **%EFS**, **ES** (Errored Seconds), **%ES**, **SES** (Severely Errored Seconds), **%SES**, **FAILED**, **%FAILED**, **AVAIL**, **%AVAIL**, **UNAVAIL**, and **%UNAVAIL**. Counts are displayed in 15-minute blocks for up to 24 hours at a time. If the **935AT** is connected to a printer (or a computer), the information is not limited to the last 24 hours.

**5-44.1 Example: MON 1&2 Mode**

To obtain a **T1 error history** in **MON 1&2** mode:

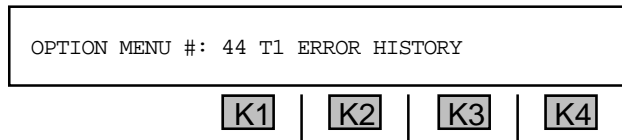
1. Connect your test cords to the **935AT** as shown in **Figure 5-44**.
2. Press the **Option Menu** function key.



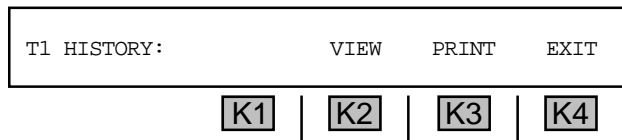
PCM Mode: MON -1&2

**Figure 5-44**  
**Monitoring in Both Directions**

3. Use the **Up/Down Arrow** keys to scroll through the option menus, **OR** select **44** using the **numeric keypad** and press the **Option Menu** function key. The display reads:



4. Press **ENT** or any softkey (**K1-K4**) to activate your selection. The display reads:



Option Menu #: 44

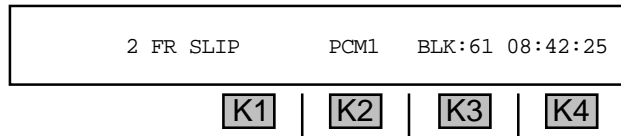
### 5-44.2 View

If you reset the counters in **OPTION MENU #: 43**, there is no error history.

To **review errors** that have occurred over the past **24** hours:

1. Press **K2** under **VIEW** and the history display will come up showing the latest block in which error data has accumulated.

*for example:*



The above display shows the 61st 15-minute block of time since the test began (roughly 15 hours).

2. Press **K1** or the **Up/Down Arrow** keys to scroll through the remaining tests:

CODE ERR	CER	FAS ERR	CRCRS
BIT SLIP	FR SLIP	FAS LOSS	NO PCM
EFS	%EFS	ES	%ES
SES	%SES	FAILED	%FAILED
AVAIL	%AVAIL	UNAVAIL	%UNAVAIL

3. If the **935AT** is monitoring both sides of the line, press **K2** to toggle to **PCM2**. The same results apply as for **PCM1**.
4. Press **K3** under **BLK:** to scroll through the remaining blocks **OR** enter a number from the **numeric keypad** to enter a specific block.

### 5-44.3 Print

You may connect a printer or computer to the **935AT** and view the results via terminal or printout. (Refer to **Section 6, Remote Control Operation** for instructions on connecting a printer or computer and **Section 6-4.4 Printing Test Results** for instructions on the print function.)

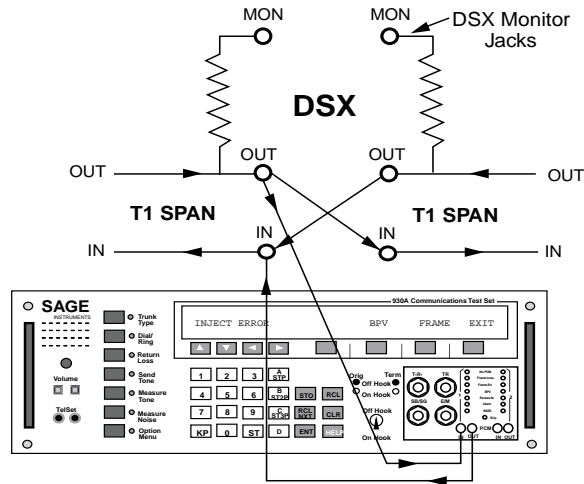
**Section V Option Menu Numbers**

**5-45 OPTION MENU #: 45 T1 ERROR INJECT**

**OPTION MENU #: 45 T1 Error Inject** is a standard feature that enables you to inject a single BPV, Frame Error or CRC Error in all PCM modes. It can also enable you to inject rates of these error types. Refer to **Section 4, PCM Operation** for setup information.

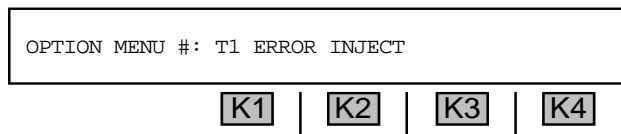
To inject a **single BPV**:

1. Connect the **935AT** when operating in the **TERMINATE** mode (simulating a channel bank) as shown in **Figure 5-45.1**.
2. Press the **Option Menu** function key.



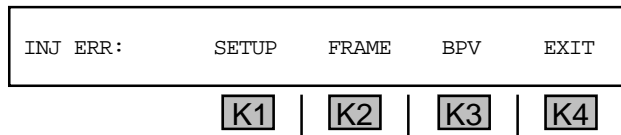
**Figure 5-45.1  
Injecting Bit Errors  
with the 935AT**

3. Use the **Up/Down Arrow** keys to scroll through the option menus, **OR** select **45** using the **numeric keypad** and press the **Option Menu** function key. The display reads:



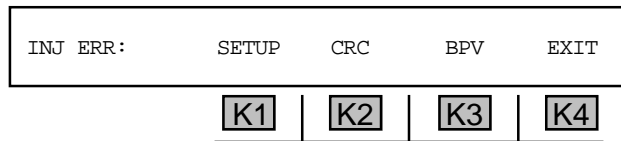
4. Press **ENT** or any softkey (**K1-K4**) to activate your selection.

If you are in **D4/SF** (Superframe), the display reads:



Option Menu #: 45

If you are in **ESF** (Extended Superframe) the display reads:



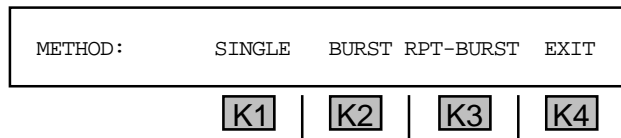
- Press the softkey (**K1-K4**) beneath the type of error you want the **935AT** to send. To inject a Bipolar Violation, press **K3** under **BPV**. To inject a **FRAME** error in **D4/SF**, or a **CRC** error in **ESF**, press **K2**.

The display will momentarily flash a cursor over the error being injected. If you are testing on a looped back facility, the **935AT** will record the error coming back.

### 5-45.1 Setup

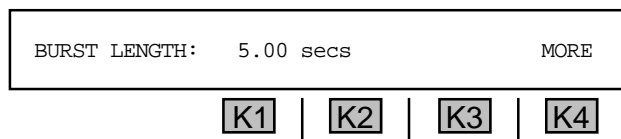
To select an injection method:

- Press **K4** under **MORE** from the **INJ-RATE** display. The new display will be one of the following, depending on the last method selected:



- Press **K1** to select **SINGLE**, **K2** to set the method to **BURST**, or press **K3** to set the method to **REPEATING BURST**.

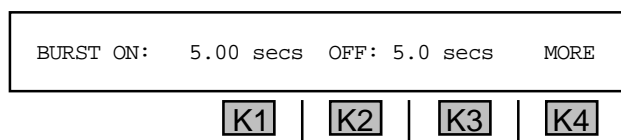
If you selected **BURST** as a method, the display reads:



Use the **numeric keypad** to enter a new **burst length**.

- A valid **burst length** is between **0.02** and **15.00 secs**. The default is **5.00 secs**.

If you selected **RPT-BURST** as a method. The display reads:



## Section V Option Menu Numbers

---

Press **K1** to change the **BURST ON** time. Use the **numeric keypad** to enter a new **burst length**.

- A valid **burst length** is between **0.02** and **15.00 secs**. The default is **5.00 secs**.

Press **K2** to change the **BURST OFF** time. Use the **numeric keypad** to enter a new **burst off time**.

- A valid **burst off time** is between **0.1** and **15.0 secs**.

### 5-45.2 Rate

---

To set an error type and error injection rate:

1. Press **K4** under **MORE** if you selected **BURST** or **RPT-BURST**. The display reads:

INJ RATE:	2.0 E -3	MORE	
<b>K1</b>	<b>K2</b>	<b>K3</b>	<b>K4</b>

2. Press **K2** to set the **mantissa of the rate**.
3. Use the **numeric keypad** to enter a new value for the mantissa of the rate.

- A valid **mantissa of the rate** is between **0.1** and **1.0**.

4. Press **K3** to set the **exponent of the rate**.
5. Use the **numeric keypad** to enter a new value for the exponent of the rate.

- A valid **exponent of the rate** is between **-9** and **-2**.

6. Press **K3** to exit to the main menu.



5-46 OPTION MENU #: 46 DS-1 BIT ERROR RATE

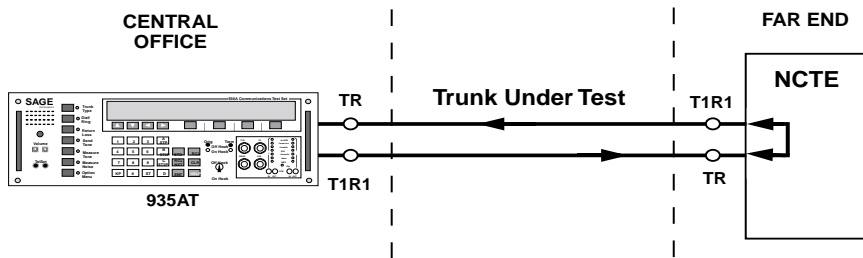
**OPTION MENU #: 46 DS-1 BIT ERROR RATE** is available only when *Purchase Option 935AT -200, BERT Test Package* is installed. This option enables the **935AT** to function as the equivalent of two BER test sets. It allows you to perform either single direction or dual direction BER tests:

- between two COs on a T1 span.
- between two COs on a T1 span with the far-end looped back.
- between a CO and a customer CSU.
- on two T1 spans simultaneously.

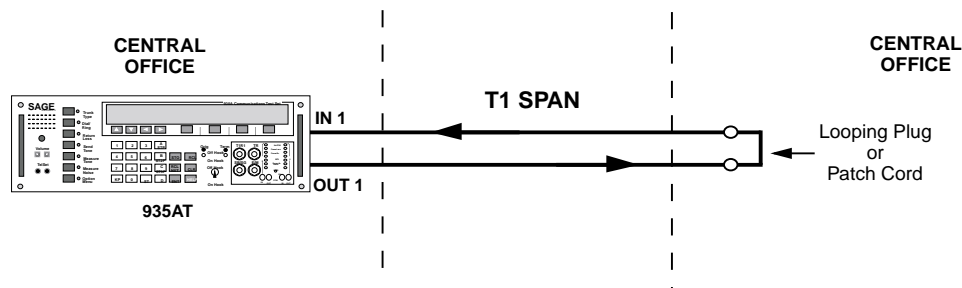
The following sections discuss each of these configurations.

5-46.1 Testing between two COs

Test setup between two COs



Test setup between two COs with far end looped back



Use the factory defaults for testing if the far-end is looped back.

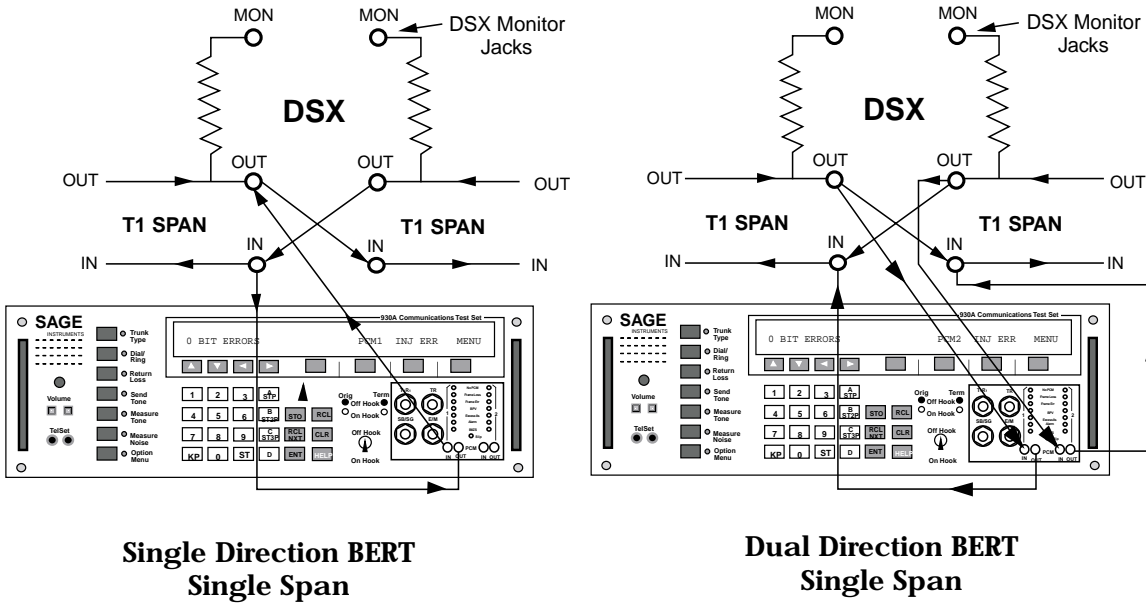
(Both side 1 and side 2 of the **935AT** are always activated upon entering **OPTION MENU #: 46**. Either side may be viewed during a test.)

Option Menu #: 46

**Section V Option Menu Numbers**

To set up either a **single** or a **dual direction test**:

1. Make sure that the T1 span you are connecting to is out of service.
2. Connect the test cords from the **935AT** to the T1 under tests according to the diagrams below:

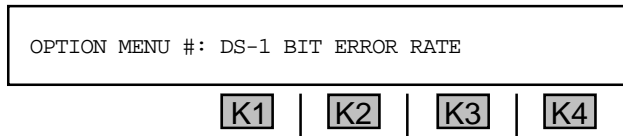


**Figure 5-46.1  
Test Cord Connections**

Option Menu #: 46

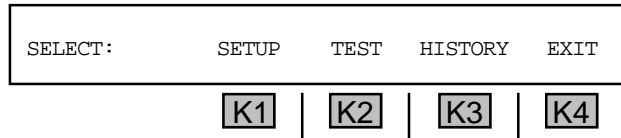
Upon entering **OPTION MENU #: 46 DS-1 BIT ERROR RATE**, the **935AT** automatically sets to T1 operation. The factory default parameter settings have been implemented to allow testing in most instances without changing any setups. Both units must be set to the same patterns and parameters to achieve sync.

3. Press the **Option Menu** function key.
4. Use the **Up/Down Arrow** keys to scroll through the option menus, **OR** select **46** using the **numeric keypad** and press the **Option Menu** function key. The display reads:



5. Press **ENT** or any softkey (**K1-K4**) to activate your selection. If the **935AT** is not in **PCM** mode, the display will momentarily read **SETTING T-1 MODE . . . STAND BY.** (Refer to **Section 4, PCM Operation** for more information.)

Once the **935AT** is in **PCM** mode, the display reads:



The following are the default parameters for testing in this option:

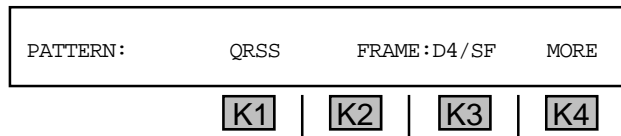
<b>PATTERN:</b>	<b>QRSS</b>
<b>FRAME:</b>	<b>D4/SF</b>
<b>CLOCK:</b>	<b>INTERNAL 1.544 Mbps ±30bps</b>
<b>IMPEDANCE:</b>	<b>100 Ohms</b>
<b>LINE CODING:</b>	<b>AMI</b>
<b>TEST LENGTH:</b>	<b>CONTINUOUS</b>

To test using the default parameters, skip to **Section 5-46.3 Test Mode**. The following sections describe the **setup** for parameters other than the defaults shown above.

## 5-46.2 Setup

To check or change the **testing parameters**:

1. Press **K1** under **SET-UP** in the **SELECT** display. The new display reads:



The default test pattern is **QRSS** and the default framing is **D4/SF**.

2. To change the test pattern, use the **Up/Down Arrow** keys or **K1** under **QRSS** to scroll through the available tests. The following tests are in order of appearance on the **935AT**:

<b>QRSS</b>	Quasi-Random Word
<b>USER</b>	User definable pattern up to 24 bits long
<b>1:1</b>	Alternating 1 and 0 pattern
<b>1:7</b>	A 1 followed by seven 0's (also 1 in 8 pattern)
<b>3 in 24</b>	Three 1's in 24 bits (a stress pattern)
<b>ALL 1's</b>	All ones pattern (Blue Alarm) if unframed
<b>LONG-PAT</b>	A special variable bit long stress pattern (Avail. with Purchase Option 34)
<b>2↑23</b>	A pseudo-random sequence 8 megabits long
<b>2↑20</b>	A pseudo-random sequence 1 megabit long
<b>2↑15</b>	A pseudo-random sequence 32 kilobits long
<b>2047</b>	A pseudo-random sequence 2047 bits long
<b>511</b>	A pseudo-random sequence 511 bits long

## Section V Option Menu Numbers

If you selected the **USER** or **LONG-PATTERN**, you must complete additional setup steps before proceeding to **step 3**. (Refer to **Section 5-46.1.3** for the **USER** pattern setup procedure or **Section 5-46.1.4** for the long pattern setup procedure. For all other patterns, the procedures continue below uninterrupted.

3. Press **K3** to scroll through the framing types: **D4/SF**, **ESF**, and **UNFRAMED**.
4. Press **K4** under **MORE** to select a clock source. The display reads:

CLOCK:	LOOP-TIME	INTERNAL	
<b>K1</b>	<b>K2</b>	<b>K3</b>	<b>K4</b>

5. Press **K1** or **K2** to select a **LOOP-TIMED** clock source, **OR** press **K3** or **K4** to have the **935AT** supply the **INTERNAL 1.544Mbps clock**. The default clock source is **INTERNAL**. After making your selection, the display advances to:

IMPEDANCE:	100OHM	>1K OHM	
<b>K1</b>	<b>K2</b>	<b>K3</b>	<b>K4</b>

6. Press **K1** or **K2** to select **100 OHM** impedance, **OR** press **K1** or **K2** to select **>1K OHM** impedance. The display advances to:

LINE CODING:	AMI	B8ZS	
<b>K1</b>	<b>K2</b>	<b>K3</b>	<b>K4</b>

7. Press **K1** or **K2** to select **AMI** (Alternate Mark Inversion) line coding, **OR** press **K1** or **K2** to select **B8ZS** (Bipolar 8 Zero Substitution) coding. The display advances to:

TEST LENGTH:	CONTINUOUS TEST	EXIT	
<b>K1</b>	<b>K2</b>	<b>K3</b>	<b>K4</b>

The default **TEST LENGTH** is **CONTINUOUS**. In this case the **935AT** will perform the test until manually disabled.

8. Use the **Up/Down Arrow** keys or press **K2** to scroll through the valid test durations.

- Available test durations are: **CONTINUOUS**, **15 MINUTES**, **1 HOUR**, and **24 HOURS**.

9. Press **K4** to return to the main display.

### 5-46.2.1 CSU Displays

For instructions on setting up a **CSU** emulation, refer to **Section 5-48**.

To set up the **935AT** for **CSU** emulation:

1. Press **K4** under **EXIT** in the **TEST LENGTH** display. The new display reads:

XMIT LEVEL:	0dB	-7.5dB	-15dB
	<b>K1</b>	<b>K2</b>	<b>K3</b>   <b>K4</b>

2. Press **K1** to select **0 dB**, **K2** to select **-7.5 dB** OR **K3** to select **-15 dB**. The display reads:

LOOPBACK:	AUTO	NOTIFY	MANUAL	OFF
	<b>K1</b>	<b>K2</b>	<b>K3</b>	<b>K4</b>

3. Press **K3** under **MANUAL** if you want to do a manual loopback now. The display reads:

MANUAL LOOPBACK:	ON	OFF	EXIT
	<b>K1</b>	<b>K2</b>	<b>K3</b>   <b>K4</b>

4. Press **K2** for **ON** OR **K3** for **OFF**.
5. Press **K4** under **EXIT** to return to the **LOOPBACK** display.
6. Press **K1** under **AUTO** if you want it to loop when it receives a loop-up command OR press **K2** under **NOTIFY** for the **935AT** to notify you when it receives a loop-up command. The display reads:

LOOP-UP:	10000	DEFAULT	EXIT
	<b>K1</b>	<b>K2</b>	<b>K3</b>   <b>K4</b>

- The default **loop-up code** is 10000.

7. Press the **CLR** key to delete any existing pattern.
8. Use the **Left/Right Arrow** keys to position the cursor over the digit you want to change.
9. Use the **numeric keypad** to enter a **1** or **0**. (The desired pattern can be up to 8 bits in length.)

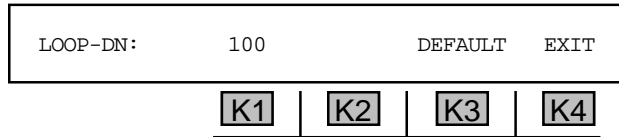
Option Menu #: 46

## Section V Option Menu Numbers

---

Use the **numeric keypad** only if you wish to type over the digit under the cursor. Use the **Up Arrow** key to insert a **0** digit under the cursor and move all digits to the right. Use the **Down Arrow** key to delete the digit under the cursor.

10. Press **K4** under **EXIT** when complete. The display reads:



11. Press the **CLR** key to delete any existing pattern.
12. Use the **Left/Right Arrow** keys to position the cursor over the digit you want to change.
13. Use the **numeric keypad** to enter a **1** or **0**. (The desired pattern can be up to 8 bits in length.)

- The default **loop-down code** is 100.

Use the **numeric keypad** only if you wish to type over the digit under the cursor. Use the **Up Arrow** key to insert a **0** digit under the cursor and move all digits to the right. Use the **Down Arrow** key to delete the digit under the cursor.

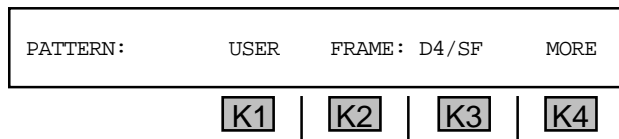
14. Press **K4** under **EXIT** when complete. You will be returned to the **SELECT** display.

### 5-46.2.2 The USER Pattern

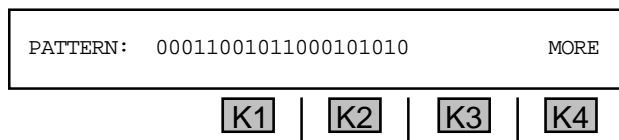
---

To access the **USER** pattern:

1. Press the **Up Arrow** or **K1** under **QRSS** from the **SETUP** display. The new display reads:



2. Press **K4** under **MORE** to display the **USER** pattern. The display reads:



3. Press the **CLR** key to delete any existing pattern.
4. Use the **Left/Right Arrow** keys to position the cursor over the digit you want to change.
5. Use the **numeric keypad** to enter a **1** or **0**. (The pattern can be up to 24 bits in length.)

- Press **K4** to advance to the clock setting display.

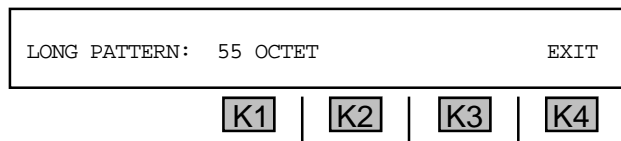
Use the **numeric keypad** only if you wish to type over the digit under the cursor. Use the **Up Arrow** key to insert a **0** digit under the cursor and move all digits to the right. Use the **Down Arrow** key to delete the digit under the cursor.

The pattern entered becomes the test pattern the **935AT** will use in the **TEST** display. By using the **935AT's STO** (store) and **RCL** (recall) functions the **935AT** can store up to **39** different **USER** patterns.

### 5-46.2.3 Long-Pattern

To setup a **long pattern**:

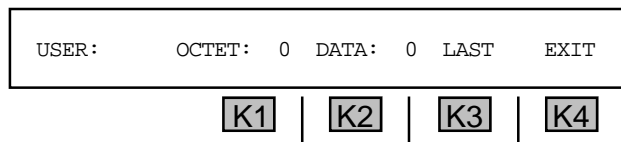
- Press the **Up Arrow** or **K1** under **QRSS** from the **SETUP** display until it reads **LONG-PAT**. The new display reads:
- Press **K4** under **MORE**. The display reads:



- Press **K1** to scroll through the available long patterns.

55 OCTET	72 OCTET	120 OCT	54 OCTET
55 DALY	96 OCTET	USER	

- Press **K4** under **EXIT**. The display reads:



- Press **K1** under **OCTET** to select the octet number for entry.
- Use the **numeric keypad** to enter a new octet number.
- Press **K1** under **DATA** to select the data number for entry.
- Use the **numeric keypad** to enter a new data number.
- Press **K3** to set the current octet as the last octet of the pattern.
- Press **K4** to exit to the clock settings display.

## Section V Option Menu Numbers

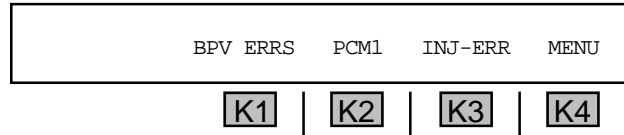
---

### 5-46.3 Test

---

To begin testing:

1. Press **K2** under **TEST** from the **SELECT** display. If you have not made any connections or your test cords are not connected correctly, you will see the message: **NO PATTERN SYNC**. Otherwise, the test results will be displayed above **K1** in the following display:



2. Press **K2** under **PCM1** to toggle between sides 1 and 2. If side 2 is not connected, you will see **NO PCM**. If side 2 is connected, the test results for **PCM2** will be displayed above **K1**.
3. Press **K1** or use the **Up/Down Arrow** keys to scroll through the available test results. Testing will continue until you exit this option or, if you selected **15 MINUTES**, **1 HOUR**, or **24 HOURS** under the **Test Length** display, the test duration has elapsed.

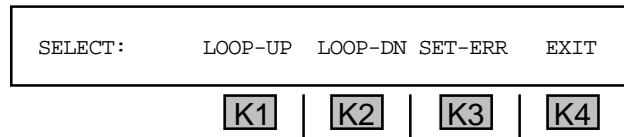
Option Menu #:  
46

### 5-46.3.1 Loop-Up/Loop Down

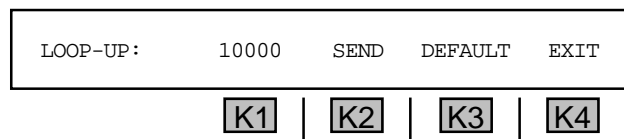
---

To loop up/loop down:

1. Press **K4** under **MENU**. The display reads:



2. Press **K1** under **LOOP-UP** to see:



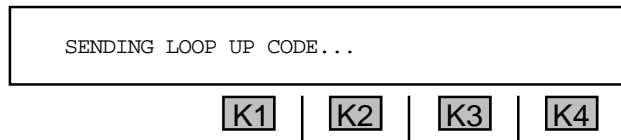
3. Press the **CLR** key to delete any existing pattern.
4. Use the **Left/Right Arrow** keys to position the cursor over the digit you want to change.
5. Use the **numeric keypad** to enter a **1** or **0** for each character in the string.

- A valid **pattern** can be up to 8 bits in length. The default loop-up code is **10000**.

Use the **numeric keypad** only if you wish to type over the digit under the cursor. Use the **Up Arrow** key to insert a **0** digit under the cursor and move all digits to the right. Use the **Down Arrow** key to delete the digit under the cursor.



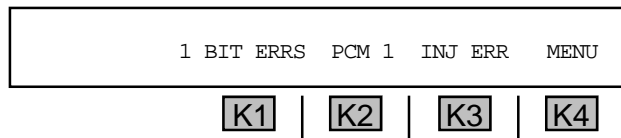
6. Press **K2** under **SEND** to send the loop-up code. The display reads:



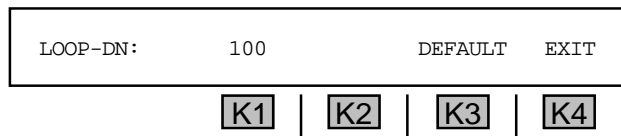
When the loop-up is completed, the display reads: **REMOTE LOOP UP ESTABLISHED**. If the loop-up is not successful the display reads: **REMOTE LOOP UP UNSUCCESSFUL** and you will return to the main **BERT** display.

If loop-up was successful and errors are detected, the **935AT** will display error indications above **K1**. If you do not see any errors within **15** minutes (scroll through all the error counters using **K1** or the **Up/Down Arrow** keys), the span is probably working. If the problem is intermittent, run the test for at least **24** hours. (Return to **Section 5-46.1 Testing Between Two COs** for information on the **935AT's TEST LENGTH**.)

7. Press **K3** under **SET-ERR** (inject error) to test the loop. The display reads:



8. Press the **CLR** key to zero the counters.
9. Press **K4** under **MENU** to return to the **SELECT** display after your testing is complete.
10. Press **K2** under **LOOP-DN**. The display reads:



11. Press the **CLR** key to delete any existing pattern.
12. Use the **Left/Right Arrow** keys to position the cursor over the digit you want to change.
13. Use the **numeric keypad** to enter a **1** or **0** for each character in the string. (The desired pattern can be up to 8 bits in length.)

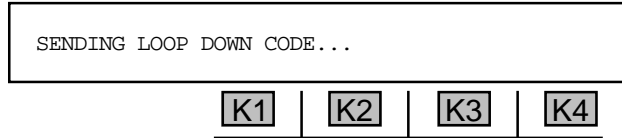
- The default **loop-down** code is 100.

Use the **numeric keypad** only if you wish to type over the digit under the cursor. Use the **Up Arrow** key to insert a **0** digit under the cursor and move all digits to the right. Use the **Down Arrow** key to delete the digit under the cursor.

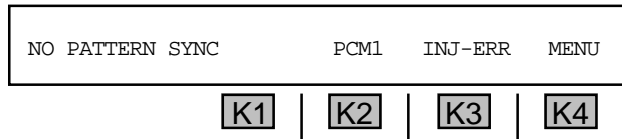
## Section V Option Menu Numbers

---

14. Press **K2** under **SEND** to restore the **CSU** to normal operation. The display reads:



When the Loop has been taken down, the display reads: **REMOTE LOOP DOWN SUCCESSFUL**. You will be returned to the main **BERT** display:



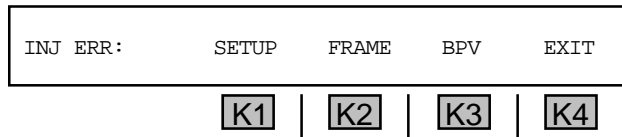
### 5-46.3.2 Set Error

---

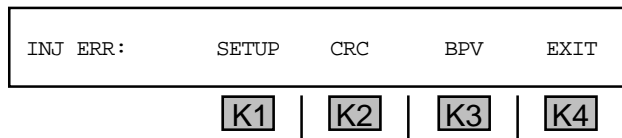
To set an error:

1. Press **K3** under **SET-ERR** from the **SELECT** menu.

If you are in **D4/SF** (Superframe), the display reads:



If you are in **ESF** (Extended Superframe) the display reads:



2. Press the softkey (**K1-K4**) beneath the type of error you want the **935AT** to send. To inject a Bipolar Violation, press **K3** under **BPV**. To inject a **FRAME** error in **D4/SF**, or a **CRC** error in **ESF**, press **K2**.

The display will momentarily flash a cursor over the error being injected. If you are testing on a looped back facility, the **935AT** will record the error coming back.

### 5-46.3.3 Method

To select an injection method:

1. Press **K4** under **MORE** from the **INJ-RATE** display. The new display will be one of the following, depending on the last method selected:

METHOD:	SINGLE	BURST	RPT-BURST	EXIT
	<b>K1</b>	<b>K2</b>	<b>K3</b>	<b>K4</b>

2. Press **K1** to select **SINGLE**, **K2** to set the method to **BURST**, or press **K3** to set the method to **REPEATING BURST**.

If you selected **BURST** as a method, the display reads:

BURST LENGTH:	5.00 secs	MORE		
	<b>K1</b>	<b>K2</b>	<b>K3</b>	<b>K4</b>

Use the **numeric keypad** to enter a new **burst length**.

- A valid **burst length** is between **0.02** and **15.00 secs**. The default is **5.00 secs**.

If you selected **RPT-BURST** as a method. The display reads:

BURST ON:	5.00 secs	OFF: 5.0 secs	MORE	
	<b>K1</b>	<b>K2</b>	<b>K3</b>	<b>K4</b>

Press **K1** to change the **BURST ON** time. Use the **numeric keypad** to enter a new **burst length**.

- A valid **burst length** is between **0.02** and **15.00 secs**. The default is **5.00 secs**.

Press **K2** to change the **BURST OFF** time. Use the **numeric keypad** to enter a new **burst off time**.

- A valid **burst off time** is between **0.1** and **15.0 secs**.

3. Press **K3** to exit testing. The display reads:

EXIT WILL CLEAR! OK?	YES	NO		
	<b>K1</b>	<b>K2</b>	<b>K3</b>	<b>K4</b>

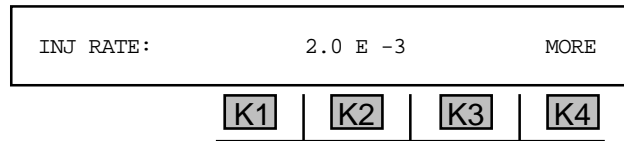
## Section V Option Menu Numbers

4. Press **K4** under **NO** to continue testing **OR K3** under **YES** to end (interrupt). You will return to the main display.

### 5-46.3.4 Rate

To set an error type and error injection rate:

1. Press **K1** under **RATE**. The display reads:



2. Press **K2** to set the **mantissa of the rate**.
3. Use the **numeric keypad** to enter a new value for the mantissa of the rate.

- A valid **mantissa of the rate** is between 0.1 and 1.0.

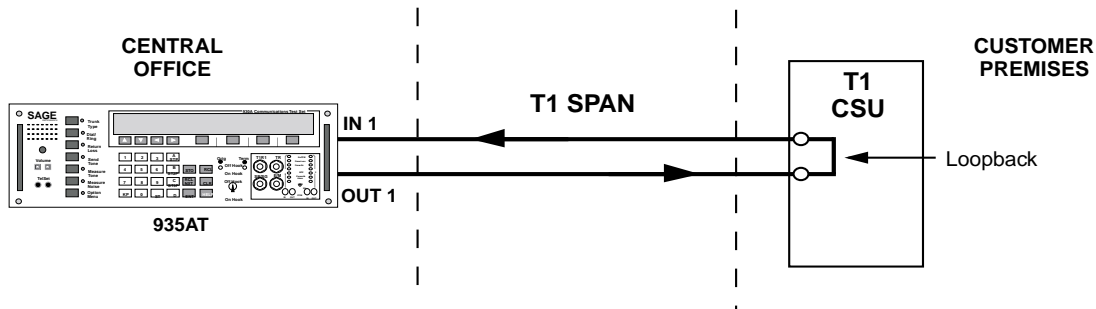
4. Press **K3** to set the **exponent of the rate**.
5. Use the **numeric keypad** to enter a new value for the exponent of the rate.

- A valid **exponent of the rate** is between -9 and -2.

6. Press **K3** to exit to the main menu.

Option Menu #:  
46

### 5-46.3.5 Testing Toward a T1 CSU



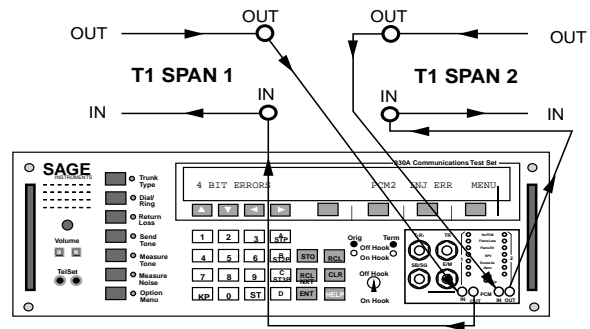
When testing on a T1 facility that terminates into a T1 Channel Service Unit (CSU) on a customers premises, the **935AT** can send the **LOOP-UP** code toward the **CSU**. This causes the **CSU** to loop the T1 back toward you.

### 5-46.3.6 BER Testing Two T1 Spans Simultaneously

Your **935AT** has the functionality of two **BERT** sets if it is equipped with *Purchase Option 935AT-200, BERT Test Package*.

To test **two T1 spans** simultaneously:

1. Connect the jacks according to the diagram on the right:
2. Press **K2** under **TEST** from the **SELECT** display.
3. Press **K2** under **PCM1** to toggle between looking at the errors on **Side 1** and those on **Side 2**. (Refer to **Figure 5-46.2** for the connection setup.)



**Figure 5-46.2**  
Two T1 Spans Being  
BER Tested Simultaneously

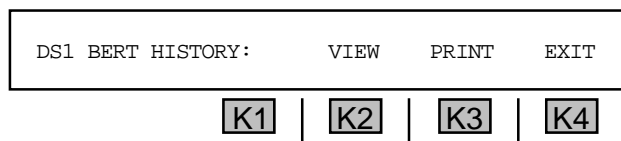
The **HISTORY** for both sides is accumulated.

4. Press **K2** to toggle between **Side 1** and **Side 2** results.

### 5-46.4 History

To review the errors which have been recorded:

Press **K3** under **HISTORY** from the **SELECT** display. If no tests have been made, you will see the message **NO BERT HISTORY AVAILABLE**. Otherwise, the display reads:



## Section V Option Menu Numbers

---

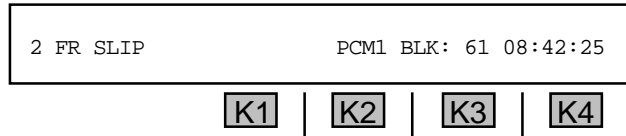
### 5-46.4.1 View

---

To view **error data**:

1. Press **K2** under **VIEW** and the history display will come up showing the latest block in which error data has accumulated.

*for example:*



The above display shows the 61st 15-minute block of time since the test began (roughly 15 hours).

2. Press **K3** under **BLK: 61** to find out what has gone on prior to this time period, or use the numeric keypad to enter the number of the block of interest. The display will begin at **BLOCK: 1**. Continue pressing **K3** to scroll through the remaining 60 blocks. (Note that the start time above **K4** changes with each block.)
3. If you are monitoring both sides of the line, press **K2** to toggle to **PCM2**. The same results apply as for **PCM1**.
4. Press **K1** or the **Up/Down Arrow** keys to scroll through the remaining tests.
5. Press the **Option Menu** function key to return to the **SELECT** display.

### 5-46.4.2 Print

---

You may connect a printer or computer to the **935AT** and view the results via terminal or printout. (Refer to **Section 6, Remote Control Operation** for instructions on connecting a printer or computer and **Section 6-4.4 Printing Test Results** for instructions on the print function.)

## 5-48 OPTION MENU #: 48 CSU EMULATION

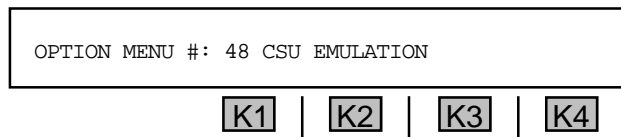
**OPTION MENU #: 48 CSU Emulation** is a standard feature that adds the special line interface functions necessary to connect directly to a **T1** span. The four major functions provided by the **CSU** Emulation option are listed below:

- Automatic line build-out (ALBO) circuit to adapt to the levels and frequency response of long spans.
- Selectable transmit line build-out with an output attenuation of **0 dB**, **7.5 dB**, or **15 dB**.
- A Simplex current path between the **IN** and **OUT** jacks with a current measurement function.
- Remote loopback functions, allowing the **935AT** to respond to in-band loopback codes and perform a line loopback function.

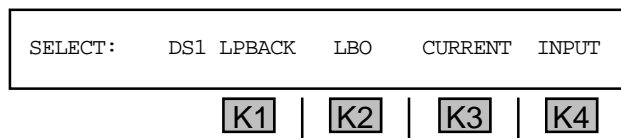
Only the **PCM1** interface is equipped with the **CSU** Emulator.

To set up the **CSU** emulation:

1. Press the **Option Menu** function key.
2. Press the **Up/Down Arrow** keys to scroll through the option menus, **OR** select **48** using the **numeric keypad** and press the **Option Menu** function key. The display reads:



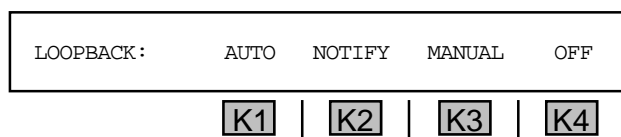
3. Press **ENT** or any softkey (**K1-K4**) to activate your selection. If the **935AT** is not in **PCM** mode, the display reads: **PCM ONLY!** You should press the **Trunk Type** function key and select **PCM**. If the **935AT** is in **PCM** mode, the display reads:



### 5-48.1 DS-1 Loopback

To configure and set **DS-1 loopback** to automatically loop when it receives a loop-up command, or to tell the **935AT** to notify you when it receives a loop-up command:

1. Press **K1** under **DS1 LPBACK**.. The display reads:



## Section V Option Menu Numbers

---

2. Press **K1** under **AUTO** to set the loopback for automatic selection. The display reads:

LOOP UP:	10000	DEFAULT	EXIT
<b>K1</b>	<b>K2</b>	<b>K3</b>	<b>K4</b>

3. Use the **numeric keypad** to enter the new **LOOP UP** code.

- The default **LOOP UP** parameter is **10000**, however, up to **8** bits are available.

4. Press **K4** under **EXIT** when complete. The display changes to:

LOOP DN:	100	DEFAULT	EXIT
<b>K1</b>	<b>K2</b>	<b>K3</b>	<b>K4</b>

5. Use the **numeric keypad** to enter the new **LOOP DN** code.

- The default **LOOP DN** parameter is **100**, however up to **8** bits are available.

6. Press **K4** under **EXIT** when complete. You will be returned to the first setup menu. The **AUTO LOOPBACK** is now set. The loopback will occur on the next loop-up command from the network.

To setup a **manual loopback**:

1. Press **K1** under **DS1 LPBACK**.
2. Press **K3** under **MANUAL** in the **LOOPBACK** display. The new display reads:

MANUAL LOOPBACK:	ON	OFF	EXIT
<b>K1</b>	<b>K2</b>	<b>K3</b>	<b>K4</b>

3. Press **K2** or **K3** to select **ON** or **OFF** to command the **CSU** loopback on or off.
4. Press **K4** to **EXIT** back to the **LOOPBACK** display.

In **NOTIFY** mode, a message is displayed when a loop command is received and the **935AT** is not in **Option Menu #: 48**. If the loop code has been detected for at least five seconds, the display will read: **CSU LOOP UP REQUEST** or **CSU LOOP DOWN REQUEST** until the loop code is sent. After being notified, the **935AT** must be manually placed into loopback.

5. Press **K4** under **OFF** to turn the manual loopback off and return to the **SELECT** display.

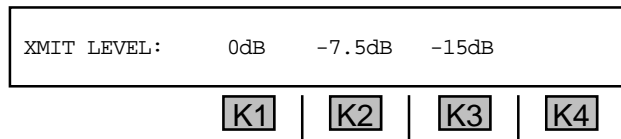


### 5-48.2 Line Build-Out

The **LBO** is set for the design criteria furnished, or based on the number of feet away from the first repeater. The maximum distance is **2500** feet.

To select the **line build-out** setting:

1. Press **K2** under **LBO**. The display reads:

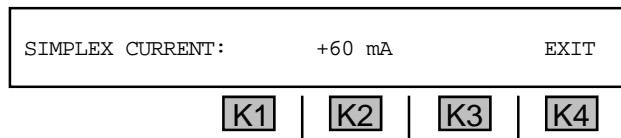


2. Press **K1** to select the default transmit parameter of **0 dB**, **K2** for **-7.5 dB** or **K3** for **-15 dB**. After pressing the proper Build-Out setting, You will be returned to the **SELECT** display.

### 5-48.3 Current

To measure the **current** on the **T1** facility:

1. Press **K3** under **CURRENT** in the **SELECT** display. An example display reads:



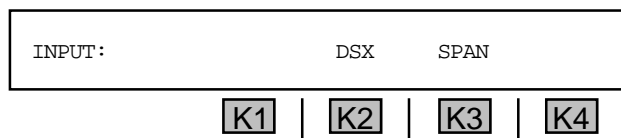
2. Press **K4** under **EXIT** to return to the **SELECT** display.

### 5-48.4 Input

The **CSU Emulation** feature will also work with **DSX** or **SPAN** terminations. Low level signals can still be monitored when required.

To change the required **T1 interface**:

1. Press **K4** under **INPUT**. The display reads:



2. Press **K2** under **DSX** to monitor a T1 span at a **DSX** point **OR** press **K3** under **SPAN** for termination on a T1 span if the signal is other than a **DSX** compatible signal, such as a frame or an RJ-45 Jack appearance. You will be returned to the main display.

**Section V Option Menu Numbers**

---

**5-52 OPTION MENU #: 52 PSQM DIRECTOR (VoIP)**

---

**OPTION MENU #: 52 PSQM Director** is available only when *Purchase Option 935AT -110, Voice Circuit Test Package* is installed. It enables you to conduct a PSQM test, with a second **935AT or 930i**, which is set to **OPTION MENU #: 53 PSQM FAR RESPONDER**, serving as the far end responder.

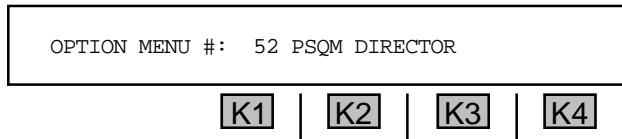
**PSQM stands for Perceptual Speech Quality Measurement.** It is an ITU-T P.861 [1] recommended objective method of estimating the subjective quality of voice-band speech codecs. The PSQM algorithm is used to measure the distortion experienced by a speech signal when transmitting through various codecs and transmission media. It differs from the signal-to-noise type of measurement in that the distortion is not measured in the normal physical domain (time or frequency domain, for example). Instead, the distortion is measured in an 'internal psychoacoustic domain' to mimic the sound perception of human subjects (phone users) in real-life situations so that the measured distortion can be easily correlated with human perceptions. This is done by converting the physical-domain signals into the perceptually meaningful psychoacoustic domain through a series of nonlinear processings such as time-frequency mapping, frequency warping, intensity warping, loudness scaling, asymmetric masking and cognitive modeling, etc.

**52-1 SETUP**

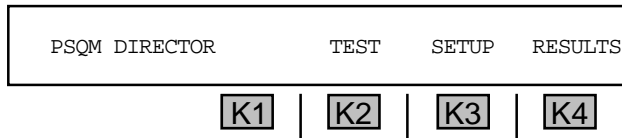
Option Menu #:  
52

To set up the **PSQM director**:

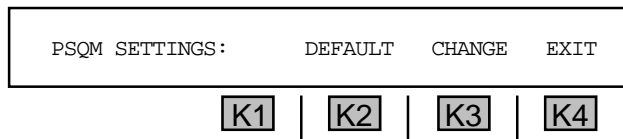
1. Press the **Option Menu** function key.
2. Use the **Up/Down Arrow** keys to scroll through the option menus, **OR** select **52** using the **numeric keypad** and press the **Option Menu** function key. The display reads:



3. Press **ENT** or any softkey. The display reads:



4. Press **K3** under **SETUP**. The display reads:



5. Press **K2** under **DEFAULT** to accept the factory defaults, or press **K3** under **CHANGE** to select new settings. If you press **K3**, the display reads:

DURATION: 10s TALK-SPEED: MEDIUM MORE			
<b>K1</b>	<b>K2</b>	<b>K3</b>	<b>K4</b>

6. Use the **numeric keypad** to change the duration of the test.

- Valid talk speeds are between **1** and **19 secs**. The default is **10 sec**.

7. Press **K3** to select a talk speed.

- Valid talk speeds are **SLOW**, **MEDIUM** and **FAST**. The default is **MEDIUM**.

8. Press **K4** under **MORE**. The display reads:

GENDER: MALE		MORE	
<b>K1</b>	<b>K2</b>	<b>K3</b>	<b>K4</b>

9. Press **K1** under **MALE** to toggle between **MALE** and **FEMALE**.

10. Press **K4** under **MORE**. The display reads:

SET TLP:	0 dB	USER	-2 dB
<b>K1</b>	<b>K2</b>	<b>K3</b>	<b>K4</b>

10. Press **K2** to select **0dB**, **K3** under **USER** to define a new TLP, or **K4** to select a **-2 dB** TLP. If you select **K3** under **USER**, the display reads:

SEND:	+0.0 dBm	RECV:	+0.0 dBm	EXIT
<b>K1</b>	<b>K2</b>	<b>K3</b>	<b>K4</b>	

11. Press **K1** to change the **SEND TLP** or **K3** to change the **RECV TLP**.

13. Use the **Numeric Keypad** to enter the desired TLP.

- A valid **SEND TLP** is between **-10 dBm** and **+10 dBm**. The default is **0 dBm**.
- A valid **RECV TLP** is between **-10 dBm** and **+10 dBm**. The default is **0 dBm**.

## Section V Option Menu Numbers

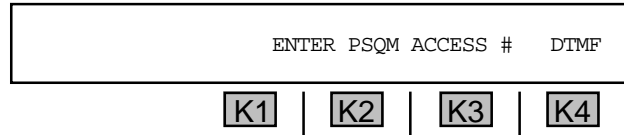
---

### 52-2 TEST

---

To begin a PSQM test:

1. Set up the **Far PSQM Responder** under **Option Menu #: 53**.
2. Press **K2** under **TEST** from the main menu. The display reads:



The number most recently entered in the **DIAL/RING** mode will be displayed in place of the word **ENTER**. Press the **CLR** key to remove any previous entry.

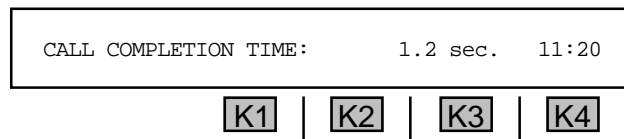
3. Press **K4** under **DTMF** to select a **DTMF**, **DP**, or **MF** outpulsing format.
4. Use the **numeric keypad** to enter a new access number.
5. Go off hook with the front panel hookswitch to begin testing. The **935AT** will seize the line, send any digits you have entered in the window, and expect the responder at the far-end to answer the call.

### 52-3 RESULTS

---

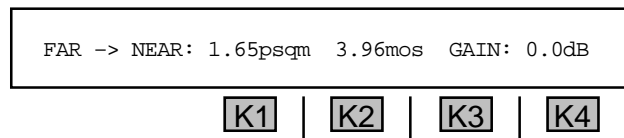
To view test results:

1. Press **K3** under results from the main menu after completing a test. If the test is successful, the display reads:



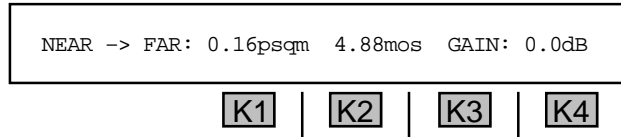
The display gives both the duration of the call, and the time at which the call was completed according to the internal clock on the **935AT**.

2. Press any softkey (**K1-K4**) The display reads:



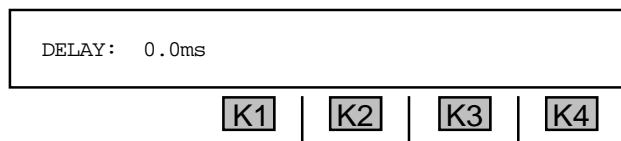
The display above **K1** and **K2** shows the results in the Far end to Near end direction in both PSQM and MOS equivalent values. The results above **K3** and **K4** are the gain results.

3. Press any softkey (**K1-K4**). The display reads:



The display above **K1** and **K2** shows the results in the Near end to Far end direction in both PSQM and MOS equivalent values. The results above **K3** and **K4** are the gain results.

4. Press any softkey (**K1-K4**). The display reads:



The display shows the results for the delay.

5. Press any softkey (**K1-K4**) to return to the main display.

If the **930i** is set to **PRINTER** mode under **OPTION MENU #: 3 REMOTE CONTROL**, or if you send an upper case **W** from a remote terminal while in **COMPUTER** mode, the results from your printer will read:

**2-Wire Trunk Type** (Normal, Loop, Term, Contact, 2W 600)

Tuesday 06-22-99 15:27:16  
7612423 PSQM ACCESS # DTMF

```
-----PSQM REPORT-----
DURATION: 10S          TALK-SPEED: MEDIUM
GENDER:  MALE
SEND TLP:  +0.0          RECV TLP:  +0.0

NEAR to FAR: 1.65psqm   3.96mos   -11.0dB
FAR to NEAR: 1.65psqm   3.96mos   -10.8dB
DELAY:  2.7ms
```

**PCM Trunk Type**

Tuesday 06-22-99 15:27:16  
7612423 PSQM ACCESS # DTMF

```
-----PSQM REPORT-----
DURATION: 10S          TALK-SPEED: MEDIUM
GENDER:  MALE
SEND TLP:  +0.0          RECV TLP:  +0.0

NEAR to FAR: 1.65psqm   4.88mos   0.0dB
FAR to NEAR: 1.65psqm   3.96mos   -10.8dB
DELAY:  2.7ms
```

## Section V Option Menu Numbers

---

### 5-53 OPTION MENU #: 53 FAR PSQM RESPONDER (VoIP)

---

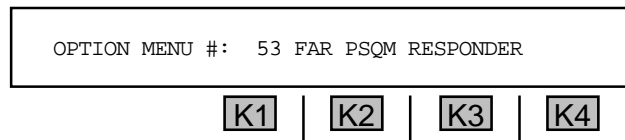
**OPTION MENU #: 53 FAR PSQM Responder** is available only when *Purchase Option 935AT -110, Voice Circuit Test Package* is installed. It enables you to set up the **935AT** to serve as the far end responder for use with another **935AT** or **930i** serving as the near end as set up in **OPTION MENU #: 52 FAR PSQM DIRECTOR**.

#### 53-1 SETUP

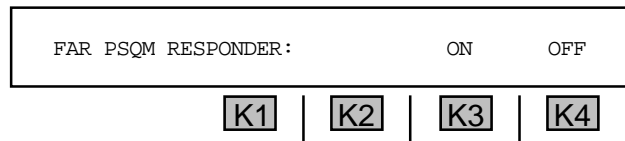
---

To set up the **PSQM director**:

1. Press the **Option Menu** function key.
2. Use the **Up/Down Arrow** keys to scroll through the option menus, **OR** select **52** using the **numeric keypad** and press the **Option Menu** function key. The display reads:



3. Press **ENT** or any softkey (**K1-K4**) to activate your selection. The display reads:



4. Press **K3** under **YES** to set the **935AT** to operate as a Far PSQM Responder **OR** press **K4** under **NO**.
5. Press the **Option Menu** function key to exit this function.

5-55 OPTION MENU #: 55 FRACTIONAL T1 BERT

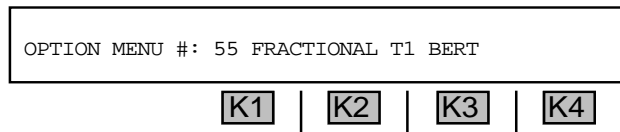
**OPTION MENU #: 55 FRACTIONAL T1 BERT** is available only when *Purchase Option 935AT-200 BERT Test Package* is installed. This feature allows you to group Contiguous, Non-Contiguous, and True Non-Contiguous **DS-0** circuits into a single Wideband Data Circuit (**fractional T1**) that can be **BERT** tested and verified for operation.

**Contiguous** refers to a group of channels on a single **T1** that are sequential, **noncontiguous** refers to a group of channels on a single **T1** that are not sequential, and **true-noncontiguous** refers to a group of channels located on multiple **T1s** that must be inverse-multiplexed. These **fractional T1** types are used primarily for transmission of data and video signals.

To test both **PCM1** and **PCM2**, set your trunk type to **PCM, D&I**. For **PCM1** only, the **935AT** must be in **TERMINATE** mode. Refer to **Section 4, PCM Operation** for setup information.

To use **fractional T1 BERT**:

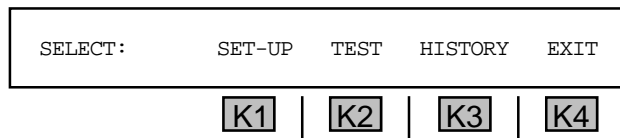
1. Press the **Option Menu** function key.
2. Use the **Up/Down Arrow** keys to scroll through the option menus, **OR** select **55** using the **numeric keypad** and press the **Option Menu** function key. The display reads:



3. Press **ENT** or any softkey (**K1-K4**) to activate your selection.

If you are not in **PCM** mode, you will see the message: **NOT IN PCM!** Use the **Trunk Type** function key to select **PCM**. (Refer to **Section 4, PCM Operation** for more details.)

If you are in **PCM**, the main **SELECT** display reads:



## Section V Option Menu Numbers

---

### 5-55.1 Setup

---

To set up a **fractional E1 BER test**:

1. Press **K1** under **SET-UP**. The display reads:

SELECT:	56 KBIT	64 KBIT	
<b>K1</b>	<b>K2</b>	<b>K3</b>	<b>K4</b>

2. Select the appropriate data rate for each **DS-0**. Press **K2** for 56 **KBIT** OR **K4** for 64 **KBIT**.

If you selected 56 **KBIT**, the display reads:

SELECT:	Nx56	TRUE-NC	
<b>K1</b>	<b>K2</b>	<b>K3</b>	<b>K4</b>

If 64 **KBIT** was selected, the message **Nx56 KBIT** is replaced with **Nx64**.

3. Press **K2** under **Nx56** or **Nx64** to select contiguous or noncontiguous **DS-0** channels OR press **K4** under **TRUE-NC** to select true-noncontiguous **DS-0** channels for the Wideband Data Circuit under test. The display reads:

CHANNELS:	—	123456789	0123456789	01234
<b>K1</b>	<b>K2</b>	<b>K3</b>	<b>K4</b>	

1-9 are channels 1-9, 0-9 are channels 10-19, 0-4 are channels 20-24.

4. Use the **numeric keypad** to enter each channel to be tested (the display will briefly read **ENTER CHANNEL #:**) and press **ENT**.

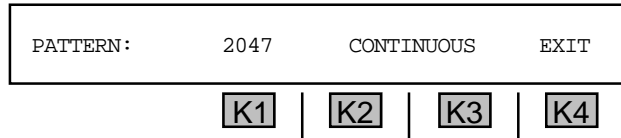
- A valid **channel number** is between 1 and 24.

If you enter the number of a channel that has already been selected, that channel will then be deselected.

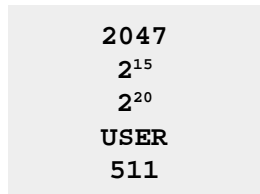
Alternately, you can press **K1** to select all channels or the **CLR** key to clear all channels. You can then use the **Left/Right Arrow** keys to place the cursor over the desired number, then change it, or enter the channel to be added/deleted using the **numeric keypad**.



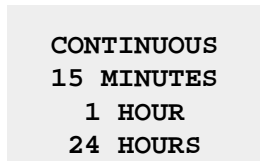
- Press the **Option Menu** function key when your channel selection is complete. The display reads:



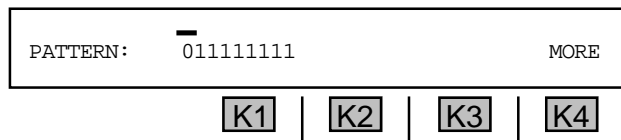
- Press **K1** to scroll through the available patterns:



- Press **K2** or **K3** to scroll through the time parameters:



- Press **K4** under **EXIT**. If you selected **USER**, the display reads:



- Use the **numeric keypad** to enter a pattern 1s and 0s. You may enter up to 8 bit patterns.

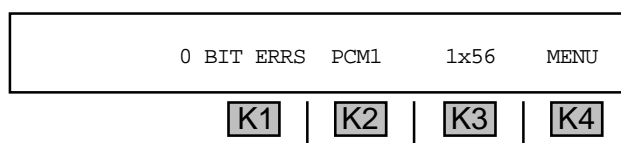
- Press **K4** under **MORE** to return to the main display.

### 5-55.2 Test

To begin testing **contiguous** and **true noncontiguous channels** for synchronization and transmission errors:

- Press **K2** under **TEST** from the main **SETUP** display.

If you selected **Nx56** the new display reads:



If **Nx64** was selected, the message **Nx56 KBIT** is replaced with **Nx64**.

## Section V Option Menu Numbers

If you selected **true-noncontiguous**, the message above **K3** reads: **TRUE-NC**.

- Press **K1** or the **Up/Down Arrow** keys to scroll through the tests and their results. The available tests are:

<b>BIT ERRS</b>	(BIT ERRORS)	<b>%EFS</b>	
<b>BER</b>	(BIT ERROR RATE)	<b>ES</b>	(ERRORED SECONDS)
<b>BPV ERRS</b>	(BIPOLAR VIOLATION ERRORS)	<b>%ES</b>	
<b>BPVR</b>	(BIPOLAR VIOLATION RATE)	<b>SES</b>	(SEVERELY ERRORED SECONDS)
<b>FR ERRS</b>	(FRAME ERRORS)	<b>%SES</b>	
<b>FR LOSS</b>	(FRAME LOSS)	<b>FAILED</b>	
<b>BIT SLIP</b>		<b>%FAILED</b>	
<b>FR SLIP</b>	(FRAME SLIP)	<b>AVAIL</b>	
<b>SLS</b>	(SYNC LOSS SECONDS)	<b>%AVAIL</b>	
<b>EFS</b>	(ERROR FREE SECONDS)	<b>UNAVAIL</b>	
		<b>ELAPSED</b>	(TIME OF TEST)

### 5-55.2.1 Testing Contiguous and Non-Contiguous Channels

To continue testing **contiguous** and **noncontiguous** channels:

- Press **K4** under **MENU**. The display reads:

SELECT:	LOOP-UP	LOOP-DN	SET-ERR	EXIT
<b>K1</b>	<b>K2</b>	<b>K3</b>	<b>K4</b>	

- If it is necessary to send a loop-up code, press **K1** under **LOOP-UP**. The display reads:

LOOP-UP:	V.54	SEND	EXIT
<b>K1</b>	<b>K2</b>	<b>K3</b>	<b>K4</b>

- Press **K4** to exit this option without sending the loop-up code **OR** send the loop-up code by pressing **K2** under **SEND**. If you choose to send a loop-up code, the display reads:

SENDING LOOPBACK CODE...			
<b>K1</b>	<b>K2</b>	<b>K3</b>	<b>K4</b>

When the loop-up is completed, you will return to the test display.

If errors are detected, the **935AT** will display error indications above **K1**. If you do not see any errors within **15** minutes (scroll through all the error counters using **K1** or the **Up/Down Arrow** keys), the span is probably working. If the problem is intermittent, run the test for at least **24** hours. (Refer to **Section 5-46.1** for information on the **935AT TEST LENGTH**.)

- Press **K4** under **MENU** to test the integrity of the loop.
- Press **K3** under **INJ ERR** (inject error) once and you will see a display similar to:

1837 BIT ERRS	INJ-ERR	EXIT	
<b>K1</b>	<b>K2</b>	<b>K3</b>	<b>K4</b>

- Press **K4** to exit this display and advance to the test screen.

If you did not specify **CONTINUOUS** testing, you will see the message: **TESTING COMPLETE** at the end of the designated test duration. You can press the **Option Menu** function key to exit this display.

If **CONTINUOUS** testing was specified, you may abort by pressing the **Option Menu** function key.

- If you press **K2** under **TEST** again, the display reads:

TEST COMPLETE, RESTART?	YES	NO	
<b>K1</b>	<b>K2</b>	<b>K3</b>	<b>K4</b>

- Press **K3** under **YES** to return to the test display and resume testing, **OR** press **K4** for **NO** to return to the **SELECT** display.

If you resumed testing, you may abort by pressing the **Option Menu** function key. Once testing is complete, you will be returned to the **SELECT** display.

- If it is necessary to send a loop-down code, press **K4** under **MENU** from the test display. The next display reads:

SELECT:	LOOP-UP	LOOP-DN	SET-ERR	EXIT
<b>K1</b>	<b>K2</b>	<b>K3</b>	<b>K4</b>	

- Press **K2** under **LOOP-DN**. The display reads:

LOOP DOWN:	V.54	SEND	EXIT
<b>K1</b>	<b>K2</b>	<b>K3</b>	<b>K4</b>

- Press **K3** to send the loop-down code. The display reads:

SENDING LOOP DOWN CODE...			
<b>K1</b>	<b>K2</b>	<b>K3</b>	<b>K4</b>

Option Menu #: 55

## Section V Option Menu Numbers

---

When the loop-down is completed, you will be returned to the test display.

12. Press the **Option Menu** function key to exit. You will be returned to the previous display.
13. Press **K4** under **EXIT** or the **Option Menu** function key to stop testing. The display reads:

EXIT WILL CLEAR! OK?	YES	NO	
<b>K1</b>	<b>K2</b>	<b>K3</b>	<b>K4</b>

14. Press **K4** under **NO** to resume testing **OR** **K3** under **YES** to end (interrupt). You will be returned to the main display.

### 5-55.2.2 Testing True-Noncontiguous Channels

---

To continue testing **true-noncontiguous** channels:

1. Press **K4** under **MENU**. The display reads:

SELECT:	SYN-STAT	ERR-STAT	INJ-ERR	EXIT
<b>K1</b>	<b>K2</b>	<b>K3</b>	<b>K4</b>	

2. Press **K1** under **SYN-STAT** to view the synchronization status, **OR** **K2** under **ERR-STAT** to view the error results.

If you selected **SYN-STAT**, the display reads:

SYNC [1-24]	<u>1</u> 23456789	0 <u>1</u> 23456789	01234
<b>K1</b>	<b>K2</b>	<b>K3</b>	<b>K4</b>

The display above shows the synchronization status for up to 24 channels on the T1 under test. A number with no line above it indicates that the indicated channel is synchronized, while a number with a line above it indicates that the channel is not synchronized. A - indicated that the channel is not enabled.

If you selected **ERR-STAT**, the display reads:

ERRS [1-24]	123 <u>4</u> 56789	0 <u>1</u> 23456789	01234
<b>K1</b>	<b>K2</b>	<b>K3</b>	<b>K4</b>

The display above shows the error status for up to 24 channels on the T1 under test. A number with no line above it indicates the absence of an error or errors on the indicated channel, while a number with a line above it indicates the presence of an error. A . indicated that the channel is not enabled.



## Section V Option Menu Numbers

---

The previous display shows the 61st 15-minute block of time since the test began.

2. Press **K3** under **BLK: 61** to find out what has gone on prior to this time period. The display will begin at Block 1. Continue pressing **K3** to scroll through the remaining 60 blocks. Note that the time above **K4** changes with each block. You can also use the numeric keypad to enter the number of the particular block of interest.
3. If you are monitoring both sides of the line, press **K2** to toggle to **PCM2**.
4. Press **K1** or the **Up/Down Arrow** keys to scroll through the remaining tests.
5. Press the **Option Menu** function key to return to the main **SELECT** display.

### 5-55.3.2 Print

---

You may connect a printer or computer to the **935AT** and view the results via terminal or printout. (Refer to **Section 6, Remote Control Operation** for instructions on connecting a printer or computer and **Section 6-4.4 Printing Test Results** for instructions on the print function.)

5-56 OPTION MENU #: 56 DS-0 BIT ERROR RATE

**OPTION MENU #: 56 DS-0 BIT ERROR RATE** is available only when *Purchase Option 935AT-200, BERT Test Package* is installed. This feature enables you to test at the **56 Kbps** or **64 Kbps** rates. It does not test individual sub-rates such as **9.6 Kbps**.

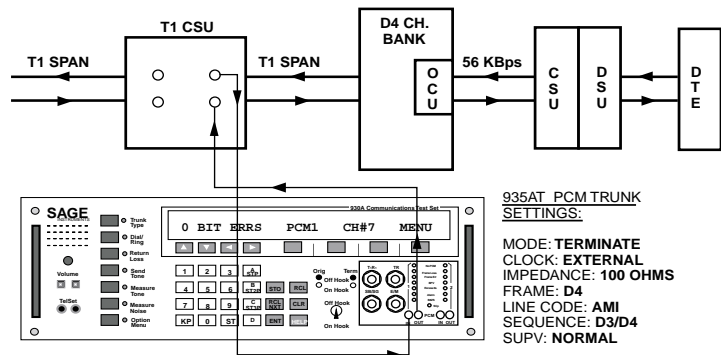
To measure the **DS-0 bit error rate**:

1. Press the **Trunk Type** function key. Select **PCM** and **TERMINATE** or **D&I** mode. (Refer to **Section 4, PCM Operation** for setup information in the **PCM** trunk type.)

If you select **AMI** line code and **ROBBED-BIT** signaling under the **PCM** trunk type, **DS-0** testing functions at **56 KB** only. If you select clear channel signaling for the **DS-1**, select the **DS-0** rate at **64KB** and **CLEAR-CHANNEL** signaling. (You cannot pass **64K DS-0 BERT** successfully unless you adhere to the **CLEAR-CHANNEL** rule above.)

2. Connect the **935AT** test cords for terminated testing as shown in **Figure 5-56.1**.

In the diagram, the **935AT** has been connected at the Equipment side of the customer's T1 Channel Service Unit (**CSU**). The testing is toward the D4 Channel Bank. There is an Office Channel Unit (**OCU**) data port plugged into time slot **7** or channel **7** on the bank. The **56 Kbps** output from the **OCU** is fed to a combination Channel Service Unit/Data Service Unit (**DSU**) which interfaces to the Data Terminal Equipment (**DTE**). To test the path successively, loopback the devices on the path and run a BER test until errors are found. Start by looping the **OCU**, then the **56 Kbps CSU**, and finally the **DSU**.



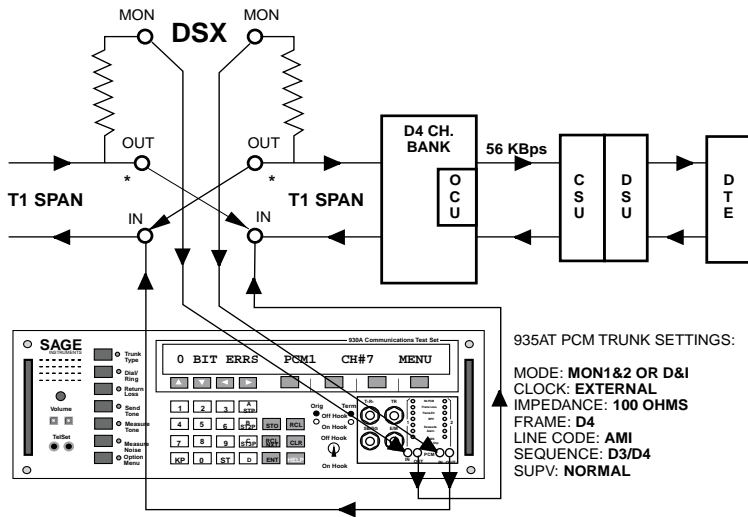
**Figure 5-56.1**  
**DS-0 BERT Configuration**

Option Menu #:  
56

**Section V Option Menu Numbers**

A **935AT** set up for Drop/Insert testing should be connected as shown in **Figure 5-56.2**.

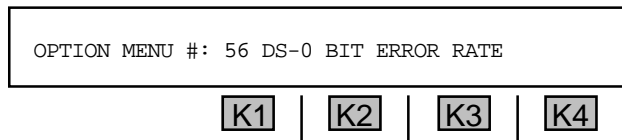
Once you have set the **935AT** correctly and connected the test cords, you can test in either direction on any channel without disturbing the other **23** channels on the T1 span.



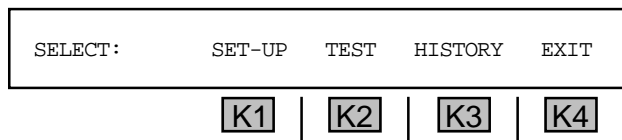
**Figure 5-56.2**  
**DS-0 BERT Drop and Insert**

Option Menu #: 56

3. Press the **Option Menu** function key.
4. Use the **Up/Down Arrow** keys to scroll through the option menus, **OR** select **56** using the **numeric keypad** and press the **Option Menu** function key. The display reads:



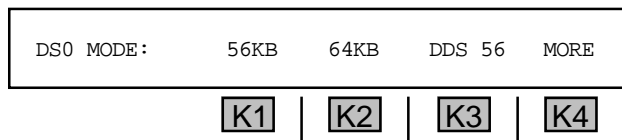
5. Press **ENT** or any softkey (**K1-K4**) to activate your selection. The **SELECT** display reads:



**5-56.1 Setup**

To set up a **DS-0 BERT** test:

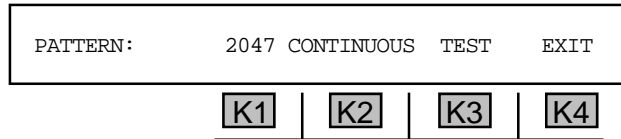
1. Press **K1** under **SET-UP**. The display reads:





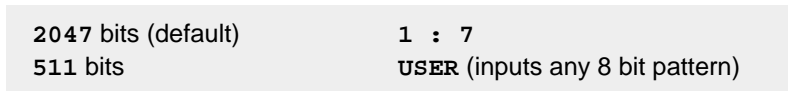
- Press **K1**, **K2** or **K3** accordingly from the **DSO MODE** display. If the cursor is highlighting your choice, you may either press the softkey (**K1-K3**) under that parameter or **K4** under **MORE**.

If you choose **56 KB**, **64 KB**, or **DDS 56** mode, the display reads:

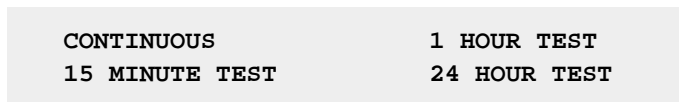


The default pattern is a **2047** pseudorandom sequence in **CONTINUOUS TEST** mode.

- Press **K1** or the **Up/Down Arrow** keys to scroll through the following pattern choices:



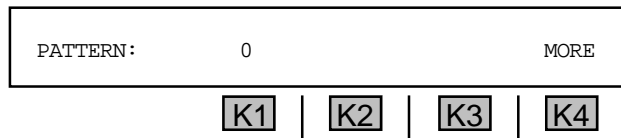
- Press **K2** or **K3** to scroll through the test durations. The following test durations are available:



- Press **K4** under **EXIT** when your pattern and test duration parameters have been chosen.

If you selected **2047**, **511** or **1 : 7** pattern, you will be returned to the main **SELECT** display.

If you selected the **USER** pattern, the next display reads:



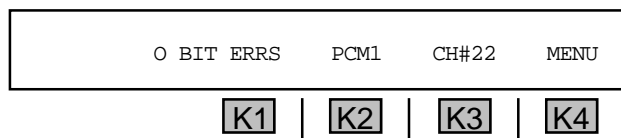
You can use the **numeric keypad** to enter any 8 bit pattern of 1s and 0s and then press **K4** under **MORE** when complete. You will be returned to the main **SELECT** display.

Option Menu #: 56

## 5-56.2 Test

To begin **DS-0** testing:

- Press **K2** under **TEST** from the **SELECT** display. The subsequent test display reads:



- Press **K1** or use the **Up/Down Arrow** keys to scroll through the following tests/ results:

## Section V Option Menu Numbers

<b>BIT ERRS</b>	(BIT ERRORS)	<b>%SES</b>	(% SEVERELY ERRORED SECONDS)
<b>BER</b>	(BIT ERROR RATE)	<b>FAILED</b>	(NUMBER OF FAILED SECONDS)
<b>SLS</b>	(SYNC LOSS ERRORS)	<b>% FAILED</b>	(% NUMBER OF FAILED SECONDS)
<b>EFS</b>	(ERROR FREE SECONDS)	<b>AVAIL</b>	(AVAILABLE SECONDS)
<b>% EFS</b>	(% ERROR FREE SECONDS)	<b>%AVAIL</b>	(% AVAILABLE SECONDS)
<b>ES</b>	(ERRORED SECONDS)	<b>UNAVAIL</b>	(UNAVAILABLE SECONDS)
<b>%ES</b>	(% ERRORED SECONDS)	<b>UNAVAIL</b>	(UNAVAILABLE SECONDS)
<b>SES</b>	(SEVERELY ERRORED SECONDS)	<b>ELAPSED</b>	(ELAPSED TIME)

- Press **K4** under **MENU** to test the integrity of the connection by injecting errors.

If you are in **56** or **64 KB**, the display reads:

SET-ERR				EXIT
<b>K1</b>	<b>K2</b>	<b>K3</b>	<b>K4</b>	

If you are in **DDS 56**, the display reads:

SELECT:	LOOP-UP	LOOP-DN	SET-ERR	EXIT
<b>K1</b>	<b>K2</b>	<b>K3</b>	<b>K4</b>	

- If you are in **56**, **64 KB**, or **DDS 56** press **K3** to advance to the error inject display **OR** if you are in **DDS56**, press **K1** to send a **loop-up** code, or **K2** to send a **loop-down** code.

If you select loop-up in **DDS56**, the display reads:

LOOP-UP:	OCU-ALB	SEND	EXIT
<b>K1</b>	<b>K2</b>	<b>K3</b>	<b>K4</b>

- Press **K1** to scroll through the loop up patterns. Available patterns are:

<b>OCU-ALB</b>	<b>DP-DROP-LLB</b>
<b>CSU-ALB</b>	<b>OCU-LLB</b>
<b>DSU-ALB</b>	<b>CSU-LLB</b>

- Press **K3** to send the loop up pattern.
- Press **K3** under **SET-ERR** to proceed, **OR** select **K3** under **EXIT** to return to the previous display. If you proceed, the next display reads:

0 BIT ERRS	INJ-ERR	INJ6ERR	EXIT
<b>K1</b>	<b>K2</b>	<b>K3</b>	<b>K4</b>

- Press **K2** to inject a single error.

9. Press **K3** under **INJ6ERR** to inject six bit errors at a time.
10. Press **K4** to return to the test display.  
If you are in **D&I** mode, you may monitor both **PCM1** and **PCM2**.
11. Press **K2** under **PCM1**. The display reads: **WILL RESTART TEST - CONT? YES NO**.
12. Press **K3** under **YES** to toggle to **PCM2**, **OR** press **K4** under **NO** to continue monitoring in **PCM1**.  
The previous error injection procedures apply when monitoring in **PCM2**.

Each time you toggle between **PCM1** and **PCM2**, the **RESTART** prompt appears.

If you did not select **CONTINUOUS** testing, the display reads: **TEST COMPLETED** at the end of the designated test duration.

13. Press the **Option Menu** function key to exit this display.

### 5-56.2.1 Point-to-Point DS-0 BERT

If you are testing point-to-point over a T1 span, use a **935AT** set at each end of the span.

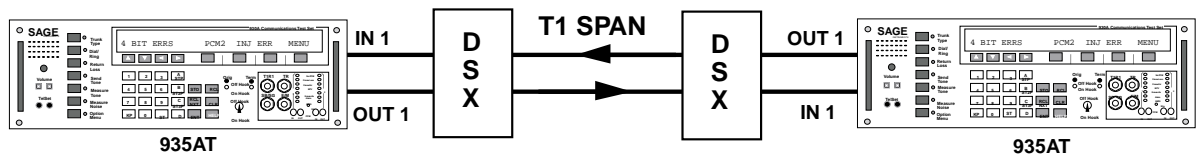


Figure 5-56.3  
DS-0 BERT with Two test Sets

### 5-56.2.2 Switched 56 KB BERT

To use a switched **56 KB BERT**:

1. Set the **PCM** trunk type to **TERMINATE** or **D&I** as appropriate.
2. Place the **hookswitch** in the **Off Hook** position.
3. Press the **Dial/Ring** function key and setup the call in the appropriate signaling type (usually dial pulse [**DP**]). (Refer to **Section 3-2.2, Dial/Ring function key**.)

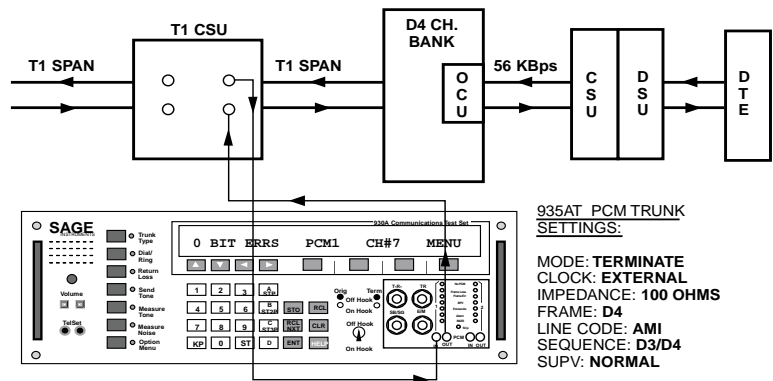


Figure 5-56.4  
Loopback BERT Setup

Option Menu #: 56

## Section V Option Menu Numbers

---

4. Return to **OPTION MENU #: 56 DS-0 BERT** and follow standard procedure as outlined in **Section 5-56.1**.
5. To drop the call at the end of the test, exit this option.
6. Place the **hookswitch** in the **On Hook** position when complete.

### 5-56.3 History

---

To review the recorded errors:

Press **K3** under **HISTORY** from the main **SELECT** display. If no tests have been made, you will see the message: **NO BERT HISTORY AVAILABLE**. Otherwise, the display reads:

DSO BERT HISTORY:	VIEW	PRINT	EXIT
<b>K1</b>	<b>K2</b>	<b>K3</b>	<b>K4</b>

#### 5-56.3.1 View

---

To view **test results**:

1. Press **K2** under **VIEW**. You will see a display similar to:

2 FR SLIP	PCM1	BLK:61	08:42:25
<b>K1</b>	<b>K2</b>	<b>K3</b>	<b>K4</b>

The above display shows the 61st 15-minute block of time since the test began.

2. To find out what has gone on prior to this time period, press **K3** under **BLK: 61**. The **935AT** display will begin at Block 1. Continue pressing **K3** to scroll through the remaining 60 blocks. Note that the time above **K4** changes with each block. You can also use the **numeric keypad** to enter a particular block of interest.
3. If you are monitoring both sides of the line, press **K2** to toggle between **PCM2** and **PCM1**.
4. Press **K1** or the **Up/Down Arrow** keys to scroll through the remaining tests.
5. Press the **Option Menu** function key to return to the main **SELECT** display.

#### 5-56.3.2 Print

---

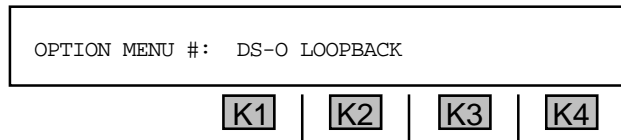
You may connect a printer or computer to the **935AT** and view the results via terminal or printout. (Refer to **Section 6, Remote Control Operation** for instructions on connecting a printer or computer and **Section 6-4.4 Printing Test Results** for instructions on the print function.)

5-57 OPTION MENU #: 57 DS-0 LOOPBACK

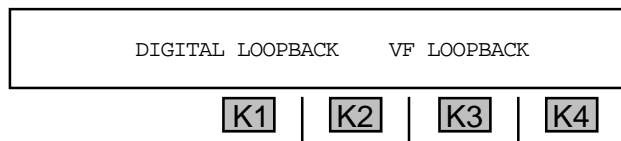
**OPTION MENU #: 57 DS-0 LOOPBACK** is available only when *Purchase Option 935AT-200, BERT Test Package* is installed. This feature enables the **935AT** to loopback the selected **PCM** channel in **TERMINATE** or drop/insert (**D&I**) modes. This is similar to a hard loopback in operation because no codes are involved. The number of bits looped depends on the signalling option selected in trunk type set up. Robbed bit is 7 bits looped, clear channel is 8 bits looped.

To put the **935AT** in **loopback mode**:

1. Press the **Option Menu** function key.
2. Use the **Up/Down Arrow** keys to scroll through the option menus, **OR** select **57** using the **numeric keypad** and press the **Option Menu** function key. The display reads:



3. Press **ENT** or any softkey (**K1-K4**) to activate your selection. The **LOOPBACK** display reads:



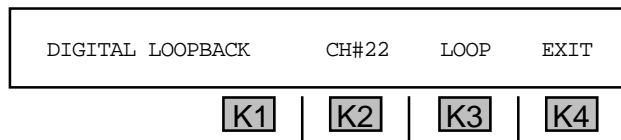
The default selection is **DIGITAL LOOPBACK**.

4. Press **K1** to loopback digital patterns (**511** or **2047** bit long patterns) **OR** press **K3** under **VF LOOPBACK** if tones (**1004 Hz**) are being sent.

Option Menu #: 57

5-57.1 Digital Loopback

If you selected **DIGITAL LOOPBACK**, the display reads:



In the above example, Channel 22 (**CH# 22**) has been looped back. You can select a channel between **1** and **24** under **PCM** trunk type. (Refer to **Section 4, PCM Operation** for setup information.)

To setup a **digital loopback**:

1. Press **K3** under **LOOP**. A cursor will appear over **LOOP** indicating that the selected channel has been looped back.

## Section V Option Menu Numbers

---

2. Press **K3** under **LOOP** to discontinue the loop **OR** press **K4** under **EXIT** to take down the loop and return to the main display. Note that only the selected channel is looped. The other **23** channels pass through unimpaired.

### 5-57.2 VF Loopback

---

If you select **VF LOOPBACK**, the display reads:

VF GAIN:	+0dB	CH#22	LOOP	EXIT
<b>K1</b>	<b>K2</b>	<b>K3</b>	<b>K4</b>	

1. Press **K1** to insert **gain** or **attenuation**.

- A valid **gain** or **attenuation** value is between **-40 dB** and **+2 dB**. The default is **0 dB**.

2. Use the **numeric keypad** to enter the value.

- A valid **channel** is between **1** and **24** under **PCM** trunk type. (Refer to **Section 4, PCM Operation** for setup information.)

3. Press **K3** under **LOOP**. A cursor will appear over **LOOP** indicating that the selected channel has been looped back. The **VF loopback** also retains the companding algorithm which is suspended during a **digital loopback**.
4. Press **K3** under **LOOP** to discontinue the loop.
5. Press **K4** under **EXIT** to take down the loop and return to the main display. Note that only the selected channel is looped. The other **23** channels pass through unimpaired.

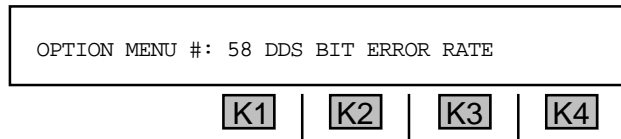
5-58 OPTION MENU #: 58 DDS BIT ERROR RATE

**OPTION MENU #: 58 DDS BIT ERROR RATE** is available only when *Purchase Option 935AT-200, BERT Test Package* is installed. This function enables operation of T1 accessed DDS functionality in the **935AT**.

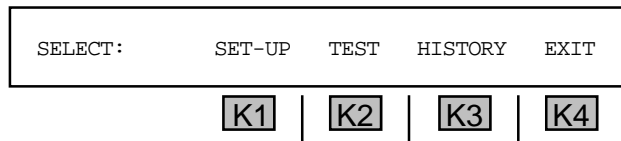
5-58.1 Setup

To set up the **DDS BER** function:

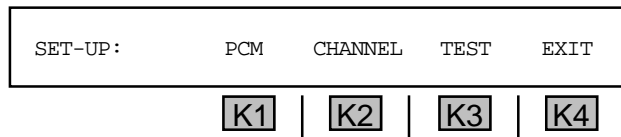
1. Press the **Option Menu** function key.
2. Use the **Up/Down Arrow** keys to scroll through the option menus, **OR** select **58** using the **numeric keypad** and press the **Option Menu** function key. The display reads:



3. Press **ENT** or any softkey (**K1-K4**) to activate your selection. The display reads:

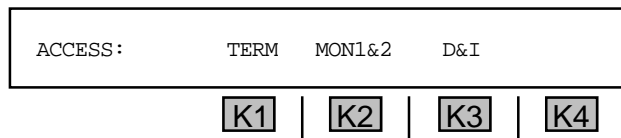


4. Press **K1** under **SET-UP**:



The **PCM** setup provides access and framing selection, which may be different than the setup in trunk type in the main **PCM** display.

5. Press **K1** under **PCM**. The display reads:



6. Press **K1**, **K2**, or **K3** as appropriate. If **TERM** is selected, you will advance to the **FRAMING** display.

Option Menu #: 58

## Section V Option Menu Numbers

---

If **MON1&2** or **D&I** is selected, the test direction must be selected before the **FRAMING** type. The test direction display reads:

RCV DIRECTION:	PCM1	PCM2
----------------	------	------

<b>K1</b>	<b>K2</b>	<b>K3</b>	<b>K4</b>
-----------	-----------	-----------	-----------

7. Press **K3** or **K4** as appropriate if you are in **MON1&2** or **D&I** mode. You will advance to the **FRAMING** display:

FRAMING:	T1DM	D4	ESF	SLC96
----------	------	----	-----	-------

<b>K1</b>	<b>K2</b>	<b>K3</b>	<b>K4</b>
-----------	-----------	-----------	-----------

8. Press the softkey (**K1-K4**) under the desired framing type. You will be returned to the main **SETUP** display.
9. Press **K2** under **CHANNEL**. The main **ACCESS** display reads:

ACCESS:	SW56	64KB	DSOA	DSOB
---------	------	------	------	------

<b>K1</b>	<b>K2</b>	<b>K3</b>	<b>K4</b>
-----------	-----------	-----------	-----------

The following subsections will show different displays depending upon the **ACCESS** type selected.

### 5-58.1.1 SW56 or 64KB Access

---

To select **SW56** or **64KB** access:

1. Press **K1** under **sw56** OR **K2** under **64KB** from the main **ACCESS** display. The new **ACCESS** display reads:

ACCESS:	CH#21	RCV-1	EXIT
---------	-------	-------	------

<b>K1</b>	<b>K2</b>	<b>K3</b>	<b>K4</b>
-----------	-----------	-----------	-----------

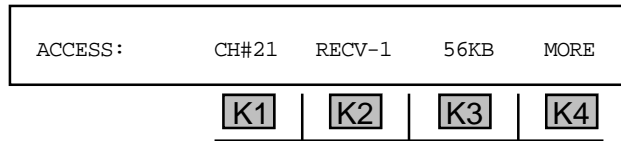
2. Use the **numeric keypad** to change the channel number.
3. Press **K2** to toggle between **RCV-1** and **RCV-2**.
4. Press **K4** under **EXIT** to return to the main **SETUP** display.



5-58.1.2 DS0A Access

To select **DSOA** access:

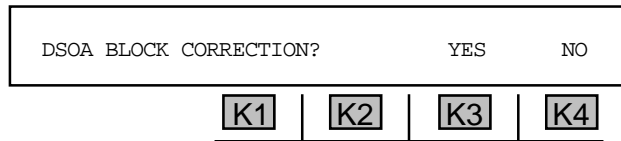
1. Press **K3** under **DS0A** from the main **ACCESS** display. The new **ACCESS** display reads:



2. Use the **numeric keypad** to change the channel number.
3. Press **K2** to toggle between **RECV-1** and **RECV-2**.
4. Press **K3** to scroll through the various baud rates.

- Valid **baud rates** are **56KB**, **2.4KB**, **4.8KB**, **9.6KB** and **19.2KB**.

5. Press **K4** under **MORE**. The display reads:



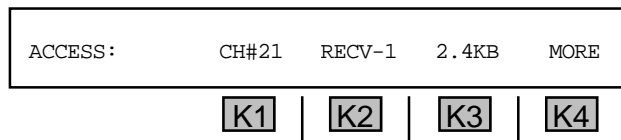
6. Press **K3** under **YES** to have the receiver perform the **DSOA** “voting” error correction algorithm on the received data before comparing it with the expected pattern to detect errors. Press **K4** under **NO** to use the first sample received.

Option Menu #: 58

5-58.1.3 DS0B Access

To select **DSOB** access:

1. Press **K4** under **DS0B** from the main **ACCESS** display. The new **ACCESS** display reads:



2. Use the **numeric keypad** to change the channel number.
3. Press **K2** to toggle between **RECV-1** and **RECV-2**.
4. Press **K3** to scroll through the various baud rates.

- Valid **access rates** are **2.4KB**, **4.8KB**, and **9.6KB**.

## Section V Option Menu Numbers

---

5. Press **K4** under **MORE**. The display reads:

DSOB SUBCHANNEL CH#1	EXIT
----------------------	------

K1	K2	K3	K4
----	----	----	----

6. Use the **numeric keypad** to enter the desired channel. The channel number under test is dependent upon your baud rate selection.

- For **2.4KB**, the valid channels are from **1** to **20**. For **4.8KB**, the valid subchannels are from **1** to **10**. For **9.6KB**, the valid channels are from **1** to **5**.

7. Press **K4** under **EXIT** when complete. You will be returned to the main **SET-UP** display.

### 5-58.1.4 Channel Selection

---

To select a **primary channel**, or a **primary and secondary channel**:

1. Press **K3** under **TEST** from the main **SELECT** display. The channel **SELECT** display reads:

SELECT:	PRI/SEC	PATTERN	ECHO-CNC	EXIT
---------	---------	---------	----------	------

K1	K2	K3	K4
----	----	----	----

2. Press **K1** to test the Primary Channel or Primary and Secondary Channels. The display reads:

TEST:	PRIMARY ONLY	PRI&SEC
-------	--------------	---------

K1	K2	K3	K4
----	----	----	----

The default selection is **PRI&SEC**. Notice the flashing cursor above **K3**.

3. Press **K1** for **PRIMARY ONLY** **OR** **K3** for **PRI&SEC** to test both the primary and secondary channels. You will be returned to the **SELECT** display.

#### 5-58.1.4.1 Pattern Selection

---

To select a **pattern**:

1. Press **K2** under **PATTERN** from the channel **SELECT** display. The new display reads:

PRI-PAT	511	CONTINUOUS TEST	MORE
---------	-----	-----------------	------

K1	K2	K3	K4
----	----	----	----

- Press **K1** or the **Up/Down Arrow** keys to scroll through the pattern choices listed below:

511	DDS-1
2047	DDS-2
2↑15	DDS-3
2↑20	DDS-4
2↑23	DDS-5
USER	

The following test durations are available:

CONTINUOUS	1 HOUR TEST	5 MINUTE TEST	24 HOUR TEST
------------	-------------	---------------	--------------

- Press **K2** or **K3** to scroll through the test durations.
- Press **K4** under **EXIT** when the pattern and test duration parameters have been chosen. If you selected the **USER** pattern, the display allows you to enter up to an **8** bit pattern of **1s** and **0s**.

The **1:7** and **USER** patterns are invalid for Alternating Loopback testing.

- Press **K4** under **MORE** to return to the previous **SELECT** display.
- If you previously selected **PRI&SEC**, press **K4** under **MORE**. The display reads:

SEC-PAT:                      63                      MORE

K1	K2	K3	K4
----	----	----	----

Valid secondary channel patterns are **63**, **511** and **2047**.

- Press **K1** or the **Up/Down Arrow** keys to scroll through the pattern selections.
- Press **K4** under **MORE** to return to the **SELECT** display.

### 5-58.1.4.2 Echo Canceller

**Echo Canceller** is only available in **SW56**, **64KB** and **DS0A** modes.

To **disable the echo canceler**:

- Press **K3** under **ECHO-CNCL** from the channel **SELECT** display. The new display reads:

SEND ECHO DISABLE TONES?                      YES                      NO

K1	K2	K3	K4
----	----	----	----

- Press **K3** to send the **2100 Hz** disable tone, **OR** press **K4** to discontinue this function. You will be returned to the channel **SELECT** display.

## Section V Option Menu Numbers

**Note:** **G.165 echo cancellers** are used to suppress unwanted echoes from the transmitted signal on a circuit. These are the most common type of echo canceller, and react to phase reversal.

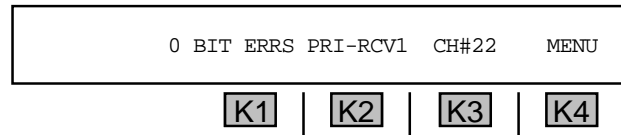
Some circuits may also have older **G.164 echo cancellers (echo suppressor)**, which do not react to phase reversal. These echo suppressors turn off transmission in the reverse direction while a person is talking in order to suppress echoes. Such suppression, however, impedes fully duplexed data, such as the bidirectional flow of data between two modems and bidirectional BERT tests.

The **echo canceller disabler** on the **935AT** sends a tone (**2100Hz** with phase reversal) for **1500 ms**, which is **ITU** compliant with **G.165 echo cancellers**. This tone is designed to disable all **G.165 echo cancellers**, although it also disables all **G.164 echo cancellers** on a circuit.

3. Press **K4** under **EXIT** or the **Option Menu** function key to return to the main **SET-UP** display.

### 5-58.2 Test

1. Press **K2** under **TEST** from the main **SELECT** display:



If either **DS0A** or **DS0B** was previously selected from the **CHANNEL** display, the above screen will show the access channel number followed by a colon and the subrate channel. For example, **CH#22:01**. The error results are displayed above **K1**.

2. Press **K1** or the **Up/Down Arrow** keys to scroll through the available tests:

<b>BIT ERRS</b>	(BIT ERRORS)	<b>FAILED</b>
<b>BER</b>	(BIT ERROR RATE)	<b>%FAILED</b>
<b>FR LOSS</b>	(FRAME LOSS)	<b>AVAIL</b>
<b>SLS</b>	(SYNC LOSS SECONDS)	<b>%AVAIL</b>
<b>EFS</b>	(ERROR FREE SECONDS)	<b>UNAVAIL</b>
<b>%EFS</b>		<b>%UNAVAIL</b>
<b>ES</b>	(ERRORED SECONDS)	<b>ELAPSED</b>
<b>%ES</b>		<b>DS0A BLK (DS0A BLOCK ERRORS)</b>
<b>SES</b>		<b>DS0B FRM (DS0B FRAME ERRORS)</b>
<b>%SES</b>		

The following errors are substituted for error count if pattern synchronization is not achieved:

**NO PCM**  
**FRAME LOSS**  
**NO PATTERN SYNC**  
**YELLOW ALARM**  
**NO DS0A SYNC**  
**NO DS0B SYNC**

3. Press **K2** under **PRI-RCV1**.

If you selected **PRIMARY ONLY** from the channel selection display, the next display reads:

SOURCE:	PRIMARY	RCV-1	RCV-2				
<table border="1" style="width: 100%; border-collapse: collapse;"> <tr> <td style="width: 25%; text-align: center;">K1</td> <td style="width: 25%; text-align: center;">K2</td> <td style="width: 25%; text-align: center;">K3</td> <td style="width: 25%; text-align: center;">K4</td> </tr> </table>				K1	K2	K3	K4
K1	K2	K3	K4				

If you selected **PRI&SEC** from the channel selection display, the next display reads:

SOURCE:	PRIMARY	SECONDARY	RCV-1	RCV-2				
<table border="1" style="width: 100%; border-collapse: collapse;"> <tr> <td style="width: 25%; text-align: center;">K1</td> <td style="width: 25%; text-align: center;">K2</td> <td style="width: 25%; text-align: center;">K3</td> <td style="width: 25%; text-align: center;">K4</td> </tr> </table>					K1	K2	K3	K4
K1	K2	K3	K4					

**RCV-2** (above **K4**) applies only in **MON1&2** and **D&I** mode.

4. If you are in the first display above, press **K3** or **K4** to change sides. The test display reflects this change above **K2**

If you are in the second display above, press **K2** to change from **PRIMARY** to **SECONDARY**

5. Press any softkey (**K1-K4**) to display the message: **WILL RESTART TEST- CONT? YES NO**.
6. Press **K3** under **YES** or **K4** under **NO** accordingly.
7. To reenter the **SOURCE** display, press **K2**. Each time a source or side is changed, the above prompt will display. You will be returned to the test display:

0 BIT ERRS	PRI-RCV1	CH#22	MENU				
<table border="1" style="width: 100%; border-collapse: collapse;"> <tr> <td style="width: 25%; text-align: center;">K1</td> <td style="width: 25%; text-align: center;">K2</td> <td style="width: 25%; text-align: center;">K3</td> <td style="width: 25%; text-align: center;">K4</td> </tr> </table>				K1	K2	K3	K4
K1	K2	K3	K4				

8. Press **K3** under **CH#**. The display reads:

SW56:	CHANNEL#22	EXIT				
<table border="1" style="width: 100%; border-collapse: collapse;"> <tr> <td style="width: 25%; text-align: center;">K1</td> <td style="width: 25%; text-align: center;">K2</td> <td style="width: 25%; text-align: center;">K3</td> <td style="width: 25%; text-align: center;">K4</td> </tr> </table>			K1	K2	K3	K4
K1	K2	K3	K4			

The far left of the display shows the channel type previously selected.

If the channel type is **DS0A**, the baud rate originally selected is also displayed. Use the **numeric keypad** to change the access channel number and press **ENT**.

If the channel type is **DS0B**, the display will show the channel type, baud rate, access channel number and subrate channel number.

## Section V Option Menu Numbers

for example:

DSOB 9.6KB	CHANNEL #22	SR-CH# 01	EXIT
------------	-------------	-----------	------

K1	K2	K3	K4
----	----	----	----

1. Press **K1** or **K2** to change the access channel.
2. Use the **numeric keypad** to enter a channel.

- A valid **channel** is between **1** and **24**.

3. Press **K3** to change the subrate channel number.

- For **2.4 KB** baud rate, the valid subrate channels are from **1** to **20**. For **4.8 KB** baud rate, the valid channels are from **1** to **10**.
- For **9.6 KB** baud rate, the valid channels are from **1** to **5**.

4. Use the **numeric keypad** to enter the new subrate channel or use the **Up/Down Arrow** keys.

If any channel change is given while in **D&I**, a warning message will be displayed:

CHANGE CHAN IN D&I?	YES	NO
---------------------	-----	----

K1	K2	K3	K4
----	----	----	----

5. Press **K3** under **YES** to change the channel and leave the unit in **D&I**, **OR** press **K4** under **NO** for no change. You will be returned to the previous display.
6. Press **K4** under **EXIT** when complete. You will be returned to the test display.

### 5-58-2.1 Multijunction Port Configuration

(For specific information on multijunction port configurations, refer to Bellcore Document TR-SY-000476.)

To select **multijunction port configuration**:

1. Press **K4** under **MENU** from the test display. The new display reads:

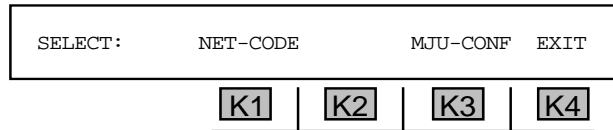
SELECT:	NETWORK	LPBACK	INJ-ERR	EXIT
---------	---------	--------	---------	------

K1	K2	K3	K4
----	----	----	----

**LPBACK** is displayed above **K2** in all modes except **64KB** mode. **NETWORK** is displayed above **K1** in **DS0A** and **DS0B** only. This allows access to the network configuration code (**NET-CODE**) displays and the multiport junction unit (**MJU**) configuration displays.

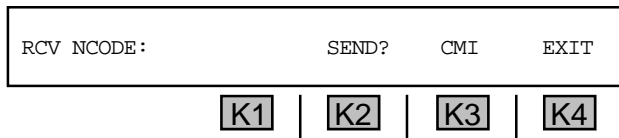
- Press **K1** under **NETWORK**:



### 5-58.2.1.1 Net-Code

To send and receive a **network configuration code** in **TERM** or **MON1** mode:

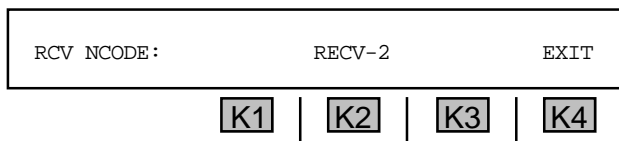
- Press **K1** under **NET-CODE**. The display reads:



- Press **K3** to scroll through the valid network configuration codes listed below:

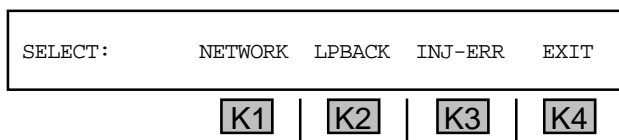
<b>CMI</b>	Control Mode Idle	<b>MJU-RES</b>	MJU-Reset
<b>TEST</b>	Test Code	<b>MJU-BLK</b>	MJU-Block
<b>OOS</b>	Out of Service	<b>MJU-UNB</b>	MJU-Unblock
<b>UMC</b>	Unassigned multiplexer Channel	<b>MJU-REL</b>	MJU-Release
<b>ASC</b>	Abnormal Station Code	<b>MJU-LBK</b>	MJU-Loopback
<b>LAT-LDN</b>	Latching Loop-down	<b>MJU-LDN</b>	MJU-Loop-down
<b>MJU-SEL</b>	MJU-Select		

- Press **K2** under **SEND?** The display changes to **SEND!** The network code is then sent.
- Press **K2** again to discontinue sending. The left side of the display shows the network configuration code received. If in **D&I** or **MON1&2** mode, the display reads:



The results are displayed above **K3**.

- Press **K4** under **EXIT** to return to the test display.
- Press **K4** under **MENU**. The display reads:



## Section V Option Menu Numbers

---

7. Press **K1** to select the **NETWORK** mode again. The display reads

SELECT:	NET-CODE	MJU-CONF	EXIT
<b>K1</b>	<b>K2</b>	<b>K3</b>	<b>K4</b>

### 5-58.2.1.2 MJU-CFG

---

To show the **multiport junction unit configuration** displays:

1. Press **K3** under **MJU-CONF** from the **SELECT** display above. The first **MJU-CFG** display reads:

MCU-CFG:	SELECT	RELEASE	MORE	EXIT
<b>K1</b>	<b>K2</b>	<b>K3</b>	<b>K4</b>	

2. Press **K3** under **MORE**. The second **MJU-CFG** display reads:

MCU-CFG:	MJU-LLB	LLB-REL	MORE	EXIT
<b>K1</b>	<b>K2</b>	<b>K3</b>	<b>K4</b>	

3. Press **K3** under **MORE** again. The third **MJU-CFG** display reads:

MCU-CFG:	BLOCK	UNBLOCK	MORE	EXIT
<b>K1</b>	<b>K2</b>	<b>K3</b>	<b>K4</b>	

4. Press **K3** under **MORE** to return to the first **MJU-CFG** display.

#### 5-58.2.1.2.1 Select

---

To **select** a branch:

1. Press **K1** under **SELECT** from the first **MJU-CFG** display. The new display reads:

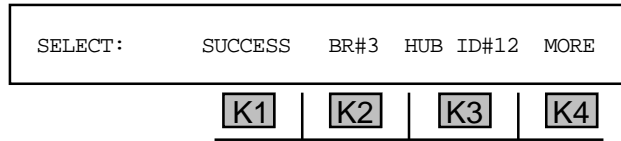
SELECT:	BRANCH#1	SEND	EXIT
<b>K1</b>	<b>K2</b>	<b>K3</b>	<b>K4</b>

2. Press **K1** or use the **Up/Down Arrow** to scroll through the four possible branch numbers.
3. Press **K3** to **SEND** the required branch select command. The display reads: **SENDING...**



If the select process was successful, the display will show the result and returned **HUB** number.

*for example:*



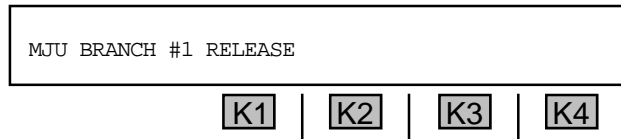
If the outcome was unsuccessful, the display shows the message **FAILED!**

4. Press **K4** under **MORE** to return to the main **MJU** display.

#### 5-58.2.1.2.2 Release

To **release** a branch:

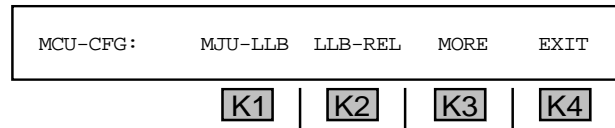
Press **K2** under **RELEASE**. The display reads:



You will then return to the main **MJU** display.

#### 5-58.2.1.2.3 More

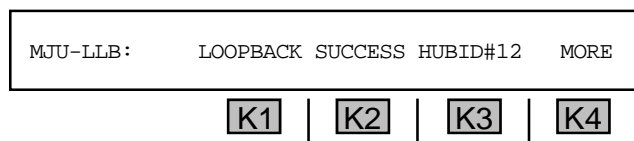
1. Press **K3** under **MORE**. The display reads:



2. Press **K1** to send the latched loopback command. The display reads: **MJU-LLB: SENDING LOOPBACK CODE...**

If the loopback was successful, the display will show the result and returned **HUB** number.

*for example:*



If the loopback was unsuccessful, the display reads: **LOOPBACK FAILED!**

## Section V Option Menu Numbers

---

3. Press **K4** under **MORE** to return to the previous **MJU** display.
4. Press **K2** under **LLB-REL** to release the latched loopback code. The display will read **SENDING LOOPDOWN CODE...** You will be returned to the previous **MJU** display.
5. Press **K3** under **MORE** to see the last **MJU** configuration display:

MCU-CFG:	BLOCK	UNBLOCK	MORE	EXIT
<b>K1</b>	<b>K2</b>	<b>K3</b>	<b>K4</b>	

6. Press **K1** under **BLOCK**.

If you have not selected a branch from the previous display, the current display reads: **MUST SELECT BRANCH FIRST**. Press **K4** under **MORE** to return to the previous display.

If you have selected a branch, the display reads:

MJU BRANCH #3	BLOCK			
<b>K1</b>	<b>K2</b>	<b>K3</b>	<b>K4</b>	

If the block is successful, the previous display is replaced by the following:

MJU BRANCH #3	BLOCK SUCCESS		MORE	
<b>K1</b>	<b>K2</b>	<b>K3</b>	<b>K4</b>	

If the block is not successful, the display reads: **BLOCK FAILED**.

7. Press **K4** under **MORE** to return to the previous **MJU** display. The **UNBLOCK** displays are identical to the **BLOCK** displays. These functions are required to clear the **MJU** Branch Block.
8. Press **K4** under **EXIT** to return to the test display.
9. Press **K4** under **MENU** to return to the main **SELECT** display.
10. Press **K2** under **LPBACK**. The display reads:

SELECT:	LOOP-UP	LOOP-DN	EXIT	
<b>K1</b>	<b>K2</b>	<b>K3</b>	<b>K4</b>	

11. Press **K2** for **LOOP-UP** function. The display reads:

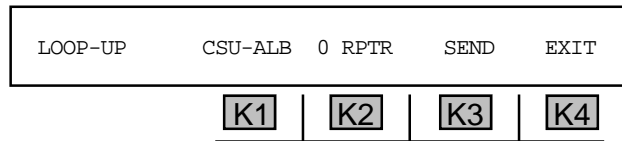
LOOP-UP	OCU-LLB	SEND	EXIT	
<b>K1</b>	<b>K2</b>	<b>K3</b>	<b>K4</b>	

12. Press **K1** or the **Up/Down Arrow** keys to scroll through alternating and latching loopback codes listed below:

<b><u>ALTERNATING CODES</u></b>	
<b>DSU-ALB</b>	Data Service Unit-Alternating Loopback
<b>CSU-ALB</b>	Customer Service Unit-Alternating Loopback
<b>56KB-RPT</b>	
<b>OCU-ALB</b>	Office Channel Unit-Alternating Loopback
<b>OCU-HL96</b>	
<b>HL96-ALB</b>	
<b><u>LATCHING CODES</u></b>	
<b>DS0DP</b>	DS-0 Data port
<b>HL222-LLB</b>	
<b>OCU-LLB</b>	Office Channel Unit-Latching Loopback
<b>CSU-LLB</b>	Customer Service Unit-Latching Loopback

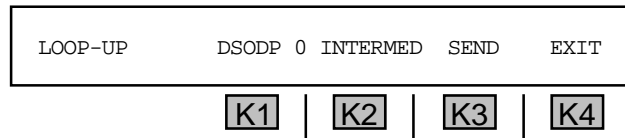
The following two loopback codes require additional information before sending.

**CSU-ALB:**



Pressing **K2** selects the number of **56 Kb** repeaters in the line between the **CSU** and the serving office. The default value is **0** with a valid range from **0 to 2**.

**DS0DP:**



The number of intermediate units when latching a **DS0DP** must be selected. Use **K2** to scroll through the units. The default value is **0** with a valid range from **0 to 7**.

13. Press **K3** under **SEND** when the desired code has been selected.

If you selected an **ALB** code, the display will read **ESTABLISHING LOOP...** If you selected an **LLB** code or **DS0DP** code, the display will read **SENDING LOOP UP CODE...**

Different codes have different establishment or send times, varying from approximately **1 to 7** seconds. Loopback success determination differs depending on the loop code sent.

After sending a loop-up code, you will be returned to the test display.

## Section V Option Menu Numbers

---

14. Press **K4** under **MENU** to send the loop-down code **OR** press **K2** under **LPBACK** to return to the following display:

SELECT:	LOOP-UP	LOOP-DN	EXIT
<b>K1</b>	<b>K2</b>	<b>K3</b>	<b>K4</b>

15. Press **K3** to send loop-down sequence. If you selected **sw56** testing, only **V.54** is a valid loop code. If you selected an **ALB** code, the display will read **LOOP CODES STOPPED...** If you selected an **LLB** code or **DS0DP** code, the display will read **SENDING LOOP DOWN CODE...**

After sending a loop-down code, you will be returned to the test display.

16. Press **K4** under **MENU** to inject errors. The display reads:

SELECT:	NETWORK	LPBACK	INJ-ERR	EXIT
<b>K1</b>	<b>K2</b>	<b>K3</b>	<b>K4</b>	

17. Press **K3** under **INJ-ERR** to see a display similar to:

12345678	ERRS SU	EXIT	
<b>K1</b>	<b>K2</b>	<b>K3</b>	<b>K4</b>

18. Press **K1** to scroll through the available error displays.

For all modes, the valid errors are **BIT ERR** and **6 BIT ERR**. In **DS0A** mode, errors include **DS0A 2:5** and **DS0A 3:5**. In **DS0B** mode, the valid errors include **DS0B FRM** (framing bit).

19. Press **K2** under **INJECT** to inject the error selected above **K3**.

20. Press **K4** under **EXIT** to return to the test display.

21. Press the **Option Menu** function key to return to the main **SELECT** display.

### 5-58.3 History

---

To **review errors** that have been recorded:

Press **K3** under **HISTORY** from the main **SELECT** display. If no tests have been made, you will see the message: **NO BERT HISTORY AVAILABLE**. Otherwise, the display reads:

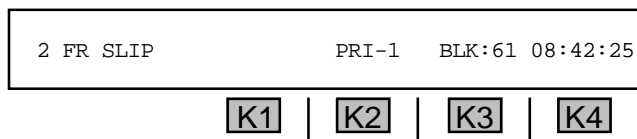
DSO BERT HISTORY:	VIEW	PRINT	EXIT
<b>K1</b>	<b>K2</b>	<b>K3</b>	<b>K4</b>

### 5-58.3.1 View

---

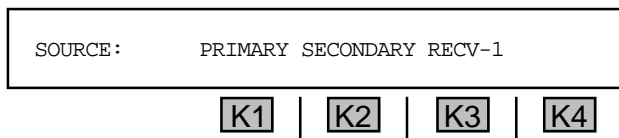
To view **test results**:

1. Press **K2** under **VIEW**. The display reads:

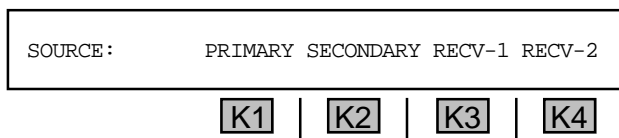


The above display shows the 61st 15-minute block of time since the test began.

2. Press **K3** under **BLK: 61** to find out what has gone on over this time period, The **935AT** display will begin at Block 1. Continue pressing **K3** to scroll through the remaining 60 blocks. Note that the time above **K4** changes with each block.
3. If you selected **PRI&SEC** channel source, press **K2** to toggle between **PRI-1** and **SEC-1**, displaying the results for each. If the Secondary Channel is not being tested, only the **PRIMARY** results are valid. Depending upon your selections, you will see a display similar to:



If the **935AT** is in **MON1&2** or **D&I**, the display reads:



4. Press **K1** or **K2** to view results on the **PRIMARY** or **SECONDARY** channel accordingly. You will be returned to the **RESULTS** display.
5. Press **K2** under the channel selection to return to the above display. Press **K3** or **K4** to view results on the appropriate side.
6. Press **K1** or the **Up/Down Arrow** keys to scroll through the remaining tests. Press the **Option Menu** function key to return to the main **SELECT** display.

### 5-58.3.2 Print

---

You may connect a printer or computer to the **935AT** and view the results via terminal or printout. (Refer to **Section 6, Remote Control Operation** for instructions on connecting a printer or computer and **Section 6-4.4 Printing Test Results** for instructions on the print function.)

## Section V Option Menu Numbers

### 5-59 OPTION MENU #: 59 ECHO CANCELLER DISABLE

**OPTION MENU #: 59 ECHO CANCELLER DISABLE** is a standard option that enables you to disable the echo canceller.

**G.165 echo cancellers** are used to suppress unwanted echoes from the transmitted signal on a circuit. These are the most common type of echo canceller, and react to phase reversal.

Some circuits may also have older **G.164 echo cancellers (echo suppressors)**, which do not react to phase reversal. These echo suppressors turn off transmission in the reverse direction while a person is talking in order to suppress echoes. Such suppression, however, impedes fully duplexed data, such as the bidirectional flow of data between two modems and bidirectional BERT tests.

The **echo canceller disabler** on the **935AT** sends a tone (2100 Hz with phase reversal) for **1500 ms**, which is **ITU** compliant with **G.165 echo cancellers**. This tone is designed to disable all **G.165 echo cancellers**, although it also disables all **G.164 echo cancellers** on a circuit.

Option Menu #:  
59

To disable the **echo canceller**:

1. Press the **Option Menu** function key.
2. Use the **Up/Down Arrow** keys to scroll through the option menus, **OR** select **59** using the **numeric keypad** and press the **Option Menu** function key. The display reads:

OPTION MENU #: 59 ECHO CANCELLER DISABLE				
K1	K2	K3	K4	

3. Press **ENT** or any softkey (**K1-K4**) to activate your selection. The display reads:

MODIFY:	LEVEL	FREQ	TIMING	PHASING
K1	K2	K3	K4	

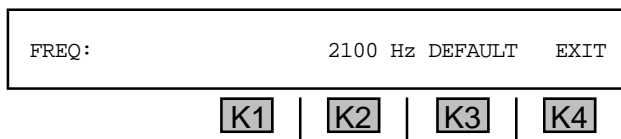
4. Press **K1** under **LEVEL** to change the level. The display reads:

LEVEL:	-12.0	dBSTLP	DEFAULT	EXIT
K1	K2	K3	K4	

5. Use the **numeric keypad** to enter a new level, and then press **K4** to exit to the **MODIFY** display.

- A valid **level** is between **-99.9 dB STLP** and **99.9 dB STLP**, **OR** between **-99.9 dBm** and **99.9 dBm**. The default is **-12.0 dB STLP**. Press **K2** to toggle between **dB STLP** and **dBm**.

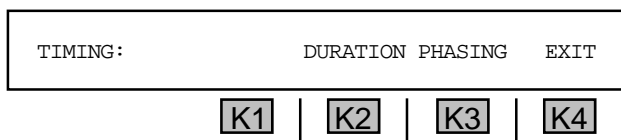
6. Press **K2** under **FREQ** to change the frequency. The display reads:



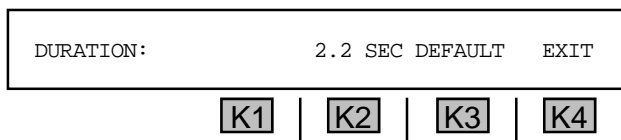
7. Use the **numeric keypad** to enter a new frequency, and then press **K4** to exit to the **MODIFY** display.

- A valid **frequency** is between 20 Hz and 5000 Hz. The default is 2100 Hz.

8. Press **K3** under **TIMING** to change the timing and phasing. The display reads:



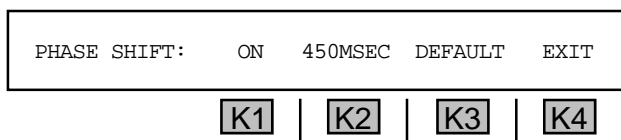
9. Press **K2** under **DURATION**. The display reads:



10. Use the **numeric keypad** to enter a new duration and then press **K4** to exit to the previous display.

- A valid **duration** is between 0 SEC and 99.9 SEC The default is 2.2 SEC.

11. Press **K3** under phasing. The display reads:



12. Press **K1** to toggle phase shift on/off.

13. Use the **numeric keypad** to change the phase shift.

- A valid **phase shift** is between 10 MSEC and 9999 MSEC. The default is 450 MSEC.

14. Press **K4** to exit to the main display.

## Section V Option Menu Numbers

---

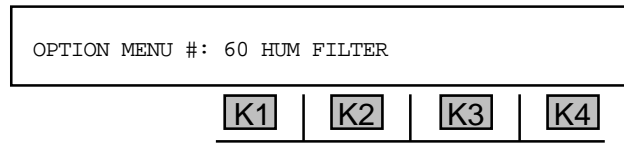
### 5-60 OPTION MENU #: 60 HUM FILTER

---

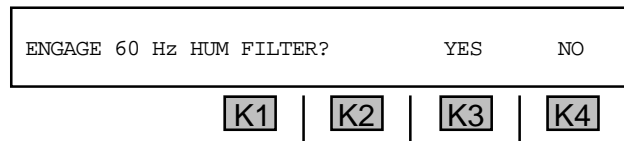
**OPTION MENU #: 60 HUM FILTER** is a standard feature that enables you to engage a **60 Hz HUM** filter.

To engage a **HUM** filter:

1. Press the **Option Menu** function key.
2. Use the **Up/Down Arrow** keys to scroll through the option menus, **OR** select **60** using the **numeric keypad** and press the **Option Menu** function key. The display reads:



3. Press **ENT** or any softkey (**K1-K4**) to activate your selection. The display reads:



4. Press **K3** under **YES** to engage a **HUM** filter, **OR K4** under **NO** to disengage the filter.
5. Press the **Option Menu** function key to exit this option.

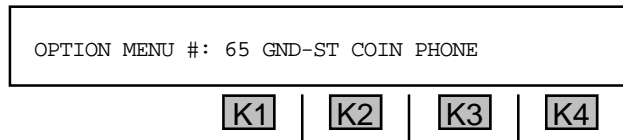


5-64 OPTION MENU #: 64 GND-ST COIN PHONE

**OPTION MENU #: 64 GND-ST COIN PHONE** is a standard feature that enables you to perform a ground start on a coin phone.

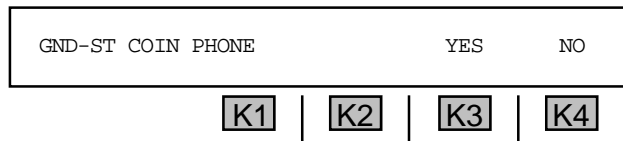
To initiate a **ground start on a coin phone**:

1. Set the **935AT** trunk type to the appropriate ground start trunk settings. (Refer to **Section 3-2.1, Trunk Type Function Key** for setup information.)
2. Press the **Option Menu** function key.
3. Use the **Up/Down Arrow** keys to scroll through the option menus, **OR** select **65** using the **numeric keypad** and press the **Option Menu** function key. The display reads:



4. Press **ENT** or any softkey (**K1-K4**) to activate your selection.

If the **935AT** is not in Ground Start mode the display reads: **NOT APPLICABLE**. Otherwise, the display reads:



5. Press **K2** under **YES** to put the **935AT** in the coin phone mode. The **935AT** functions and menu options continue to operate as usual.
6. Press the **Option Menu** function key to exit this option.

## Section V Option Menu Numbers

### 5-65 OPTION MENU #: 65 ATME FAR END RESPONDER

**OPTION MENU #: 65 ATME FAR END RESPONDER** is available only when *Purchase Option 935AT-110, Voice Circuit Test Package* is installed. This feature enables you to configure the **935AT** as an ATME Far End Responder. The **935AT** can also provide this function directly on a **E1 PCM** channel. **ATME** can measure **Loss, Noise, Noise with Tone, Gain-Slope, Return Loss, and BERT**.

To use the **935AT** as a **far-end responder**:

1. Use the **Trunk Type** function key to set up the **935AT** to operate on a **PCM** trunk. (Refer to **Section 3-2.1, Trunk Type Function Key** and **Section 4, PCM Operation** for the correct trunk type setup in Responder mode.)
2. Connect the **935AT** to the circuit.
3. Press the **Option Menu** function key.
4. Use the **Up/Down Arrow** keys to scroll through the option menus, **OR** select **65** using the **numeric keypad** and press the **Option Menu** function key. The display reads:

OPTION MENU #: 65 ATME FAR END RESPONDER

**K1** | **K2** | **K3** | **K4**

5. Press **ENT** or any softkey (**K1-K4**) to activate your selection. The display reads:

SET TLP                      0dB      USER    -2dB

**K1** | **K2** | **K3** | **K4**

6. Press **K1** to advance the display to the next display without changing any parameters, press **K2** to select **0 dB**, press **K3** under **USER** if you need to set a Send or Receive **TLP** value other than the standard **0** or **-2 dB** values, **OR** press **K4** to select **-2 dB TLP**.

If you press **K3** under **USER**, the display reads:

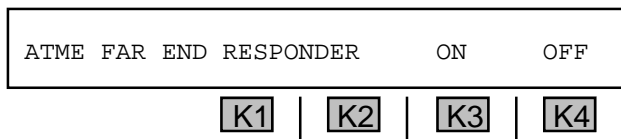
SEND:      -0002dBm    RECV: -0002dBm    EXIT

**K1** | **K2** | **K3** | **K4**

7. Press **K1** to change the **SEND TLP** or **K3** to change the **RECV TLP**.
8. Use the **numeric keypad** to enter the desired **TLP**.

- A valid **SEND TLP** is between **-25 dBm** and **+7 dBm**.
- A valid **RECV TLP** is between **-16 dBm** and **+7 dBm**.

9. Press **ENT** or any softkey (**K1-K4**) to complete the selection.
10. Press **K4** to **EXIT**. The display reads:



11. Press **K3** to enable the Far End Responder. A cursor will appear over the **ON** indication. The **935AT** is now acting as an ATME Responder waiting to be accessed. The above display appears regardless of whether or not the **935AT** is in manual sequence mode.
12. Press **K3** to enable the responder function.

When accessed by ringing or far-end seizure, the **935AT** goes off-hook. The **935AT** then waits for **MF** commands and performs the corresponding tests. The **935AT** will continue in this mode until:

1. It is released by the calling party via an **MF** "release" command.
2. The calling party goes on-hook (see following notes).
3. No **MF** command is received for **20** seconds (**935AT** defaults to Manual mode if selected).
4. The operator selects **OFF** or discontinues testing in any way.

When the **935AT** is released, or the calling party goes on-hook, the **935AT** goes on-hook for one second and then awaits seizure or ringing. If the **935AT** is allowed to time out (**20** seconds without an **MF** command), it will either go on-hook, or initiate the manual test sequence (if selected).

If the **935AT** is on a loop trunk simulating the subscriber (providing **CONTACT** rather than **BATTERY**), it will expect the far end to remain on-hook, and will not treat this as a release condition.

13. Press the **Option Menu** function key to exit this option.

## Section V Option Menu Numbers

### 5-66 OPTION MENU #: 66 ATME DIRECTOR

**OPTION MENU #: 66 ATME DIRECTOR** is available only when *Purchase Option 935AT-110, Voice Circuit Test Package* is installed. This feature enables you to set up the **935AT** as an **ATME** near end responder that controls the **ATME** far end responder featured in **OPTION MENU #: 65 ATME FAR END RESPONDER**. This feature enables you to conduct impedance, BERT and echo canceller tests, including:

- 1020Hz@0dBm
- 400Hz@0dBm
- 2800Hz@0dBm
- 1020Hz@-10dBm
- 400Hz@-10dBm
- 2800Hz@-10dBm
- Noise/CMS
- S/TDHz with -10dBm tone
- S/TD with -25dBm tone
- EC LEVEL
- Far to Near Noise
- Near to Far noise
- Bypass Loss
- BER test (in PCM only)

To use the **ATME Director** feature:

1. Select a trunk type. (Refer to **Section 3, Function Key Operation** and **Section 4, PCM Operation** for the correct trunk type setup in Responder mode.)
2. Connect the **935AT** to the circuit.
3. Press the **Option Menu** function key.
4. Use the **Up/Down Arrow** keys to scroll through the option menus, **OR** select **66** using the **numeric keypad** and press the **Option Menu** function key. The display reads:

OPTION MENU #: 66 ATME DIRECTOR

K1 | K2 | K3 | K4

5. Press **ENT** or any softkey (**K1-K4**) to activate your selection. The display reads:

ATME DIRECTOR: TEST SET-UP RESULTS

K1 | K2 | K3 | K4

#### 5-66.1 Setup

To set up the **ATME director**:

1. Press **K3** under **SET-UP**. The **SET TLP** display reads:

SET TLP 0dB USER -2dB

K1 | K2 | K3 | K4

2. Press **K1** to advance to the next display without changing any parameters, press **K2** to select **0 dB**, press **K3** under **USER** if you need to set a Send or Receive **TLP** value other than the standard **0 dB** or **-2 dB** values, or press **K4** to select **-2 dB TLP**.

If you press **K3** under **USER**, the display reads:

SEND:	+0dBm	RECV: +0dBm	EXIT
<b>K1</b>	<b>K2</b>	<b>K3</b>	<b>K4</b>

3. Press **K1** to change the **SEND TLP** or **K3** to change the **RECV TLP**.
4. Use the **numeric keypad** to enter the desired **TLP**.

- A valid **SEND TLP** is between **-25 dBm** and **+7 dBm**.
- A valid **RECV TLP** is between **-16 dBm** and **+7 dBm**.

5. Press **K4** under **EXIT** to advance to the **LEVEL** displays. The first display reads:

LEVEL:	1KHZ@0	3TONE@0	MORE
<b>K1</b>	<b>K2</b>	<b>K3</b>	<b>K4</b>

6. Press the softkey (**K1-K4**) under a level to select or deselect it. (Levels are in **kHz@dBm0**.) A cursor appears above your selections.
7. Press **K4** under **MORE**. The next **LEVEL** display reads:

LEVEL:	1KHZ@-10	3TONE@-10	MORE
<b>K1</b>	<b>K2</b>	<b>K3</b>	<b>K4</b>

8. Press the softkey (**K1-K4**) under a level to select or deselect it. (Levels are in **kHz@dBm0**.) A cursor appears above your selections.
9. Press **K4** under **MORE** to advance the **NOISE** display:

NOISE:	PSOPH	S/TD@-10	S/TD@-25	MORE
<b>K1</b>	<b>K2</b>	<b>K3</b>	<b>K4</b>	

10. Press the softkey (**K1-K4**) under a filter to select or deselect it. You can enable **Psophometric** noise, or **S/TD** at **10 dBm0** or **25 dBm0**. A cursor appears above your selections.

## Section V Option Menu Numbers

11. Press **K4** under **MORE** to advance to the **ECHO CANCELLER** display.

ECHO CAN:	FAR-EC	NEAR-EC	DISABLER	MORE
<b>K1</b>	<b>K2</b>	<b>K3</b>	<b>K4</b>	

12. Press the softkey (**K1-K4**) under an echo canceller to select or deselect it. You may select Far End Echo Canceller (**FAR-EC**), Near End Echo Canceller (**NEAR-EC**) or a **echo canceller disabler** test.

**Note:** **G.165 echo cancellers** are used to suppress unwanted echoes from the transmitted signal on a circuit. These are the most common type of echo canceller, and react to phase reversal.

Some circuits may also have older **G.164 echo cancellers (echo suppressors)**, which do not react to phase reversal. These echo suppressors turn off transmission in the reverse direction while a person is talking in order to suppress echoes. Such suppression, however, impedes fully duplexed data, such as the bidirectional flow of data between two modems and bidirectional BERT tests.

The **echo canceller disabler** on the **935AT** sends a tone (**2100Hz** with phase reversal) for **1500ms**, which is **ITU** compliant with **G.165 echo cancellers**. This tone is designed to disable all **G.165 echo cancellers**, although it also disables all **G.164 echo cancellers** on a circuit.

During an **echo canceller test**, the **935AT** sends a **500 ms** pause just before the test, which re-enables both the **G.165** and **G.164 echo cancellers**. It then sends another **2100 Hz** signal (no phase reversal) for **800 ms**, which disables only the **G.164 echo cancellers** thereby allowing the **G.165 echo cancellers** to be tested independently.

13. Press **K4** under **MORE**. If you selected a PCM trunk you will advance to the following **BERT** display. If you are in an **Analogue trunk type**. You will skip to the **CMS TONE LOCKING** display.

BERT	2↑11-1	600 SECS	EXIT
<b>K1</b>	<b>K2</b>	<b>K3</b>	<b>K4</b>

14. Press **K2** under **600 SECS** to change the **BERT** test duration.

15. Use the **numeric keypad** to enter a new test duration.

- A valid test **duration** is between **10** and **600 SECS**.

16. Press **K4** under **EXIT** to advance to the **CMS TONE LOCKING** display.

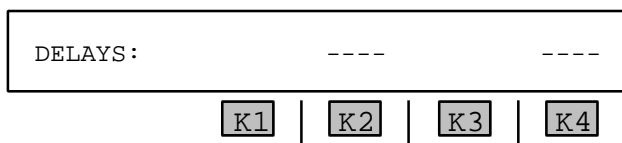
CMS TONE LOCKING?	YES	NO	
<b>K1</b>	<b>K2</b>	<b>K3</b>	<b>K4</b>

**Note:** **CMS tone locking** is tied to **G.164 echo canceller** suppression on the **935AT**. By deselecting **CMS tone locking**, the **2100 Hz** tone (no phase reversal) that is normally sent to disable **G.164 echo cancellers** during a **G.165 echo canceller test** will not be sent. This will prevent the **935AT** from isolating the **G.165 echo cancellers** from the **G.164 echo cancellers** during testing.

- 17 Press **K3** under **YES** to turn tone locking on, **OR K4** under **NO** to turn it off.
18. Press the **Option Menu** function key to exit this option.
19. Press **K2** to select **0 dB**, **K4** to select **-2 dB TLP user for a TLP**, **OR K1** to advance to the next display without changing any parameters.

If you did not select an echo canceller test, you will be returned to the main display.

If you selected an echo canceller test, you will advance to the following display:



20. Press **K1**, **K2**, or **K3** to set a delay. You can insert from one to three delays.
21. Use the **numeric keypad** to enter up to three delay durations.

- A valid **delay** is between **0 ms** and **75 ms**.

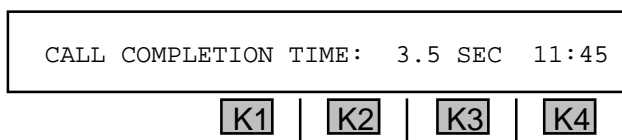
22. Press **K4** under exit to return to the main display.

## 5-66.2 Testing

---

To begin **ATME** testing:

1. Press **K2** under **TEST**. If you have connected the **935AT** to a test line and set up the test parameters correctly, the **TEST** display reads:



The **935AT** automatically conducts the test. The time for the call to be completed is displayed above **K3**. The current time is displayed above **K4**.

2. Press any softkey (**K1-K4**) to exit to the main display.

## Section V Option Menu Numbers

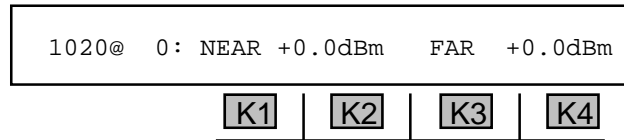
---

### 5-66.3 View

---

To view the results of the test:

1. Press **K3** under **RESULTS**. The first result display reads:



2. Use the **Arrow** keys **OR** press any softkey (**K1-K4**) to cycle through the test results. The types results are:

- 1020Hz@0dBm
- 400Hz@0dBm
- 2800Hz@0dBm
- 1020Hz@-10dBm
- 400Hz@-10dBm
- 2800Hz@-10dBm
- Noise/CMS
- S/TDHz with -10dBm tone
- S/TD with -25dBm tone
- EC LEVEL
- Far loss
- Near loss
- Bypass Loss
- BER test (in PCM only)

3. Press the **Option Menu** function key to exit to the main display.



## 5-69 OPTION MENU # 69 FAR 23 TONE RESPONDER

**OPTION MENU #: 69 FAR 23 TONE RESPONDER** is available only when *Purchase Option 935AT-100, Fax/Modem TIMS Package* is installed. This feature enables you to set up the **935AT** as a **23 tone far end responder** which is controlled by another **935AT** set up at the near-end as a **23 Tone Director**. (The **23 Tone Director** feature is described in **OPTION MENU #: 64 23 TONE DIRECTOR**.)

To use the **935AT** as a **23 tones far end responder**:

1. Use the **Up/Down Arrow** keys to scroll through the option menus, **OR** select **69** using the **numeric keypad** and press the **Option Menu** function key. The display reads:

OPTION MENU #: 69 FAR 23 TONE RESPONDER			
K1	K2	K3	K4

2. Press **ENT** or any softkey to activate your selection. The display reads:

FAR 23 TONE RESPONDER:	ON	OFF	
K1	K2	K3	K4

3. Press **K3** under **ON** to set up the **935AT** as a 23 tone far end responder, **OR** **K4** under **OFF** to deactivate the responder function.
4. Press the **Option Menu** function key to return to the main display.

## Section V Option Menu Numbers

---

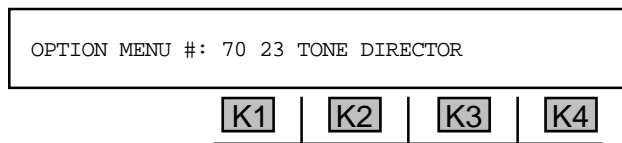
### 5-70 OPTION MENU #: 70 23 TONE DIRECTOR

---

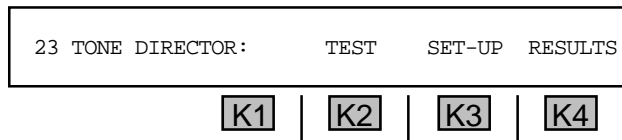
**OPTION MENU #: 70 23 TONE DIRECTOR** is available only when *Purchase Option 935AT-100, Fax/Modem TMS Package* is installed. This feature enables you to set up the **935AT** as a **23 tone director** that controls another **935AT** set up as a **23 tones far end responder**. (The **23 tone far end responder** feature is described in **OPTION MENU #: 69 FAR 23 TONE RESPONDER**.)

To use the **23 tone director**:

1. Use the **Up/Down Arrow** keys to scroll through the option menus, **OR** select **70** using the **numeric keypad** and press the **Option Menu** function key. The display reads:



2. Press **ENT** or any softkey (**K1-K4**) to activate your selection. The display reads:

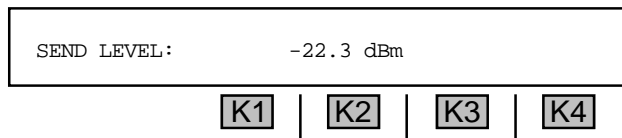


#### 5-70.1 Setup

---

To set up the **23 tones director**:

1. Press **K3** under **SET-UP**. The display reads:



2. Use the **numeric keypad** to change the level of the send tone.

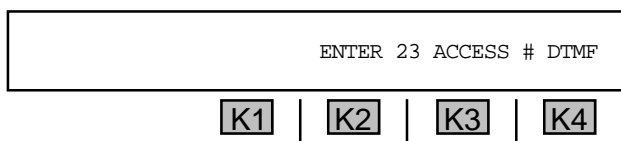
- A valid **send tone level** is between **-60.0 dBm** and **0.0 dBm**.

### 5-70.2 Test

---

To begin **23-tone testing**:

1. Press **K2** under **TEST** when you are ready to begin testing. You will see a display similar to:



The number most recently entered in the **DIAL/RING** mode will usually be displayed in place of the word **ENTER**.

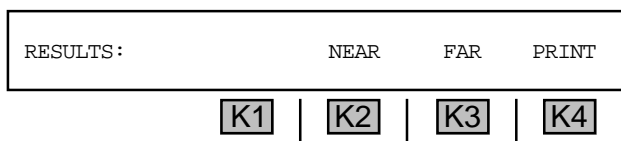
2. Press the **CLR** key to remove any previous entry and return to a display similar to the one above.
3. Press **K4** under **MF**, **DTMF**, or **DP**, depending on the mode selected, to change the outpulsing format to the type required for your circuit. This will also clear any old numbers.
4. Use the **numeric keypad** to enter the access number of the **23 tone far-end responder**.
5. Go **off-hook** with the front panel hookswitch to begin testing. The **935AT** will seize the line, send any digits you have entered in the window, and expect the responder at the far-end to answer the call. If no number has been entered in the window, no digits will be sent.

### 5-70.3 Results

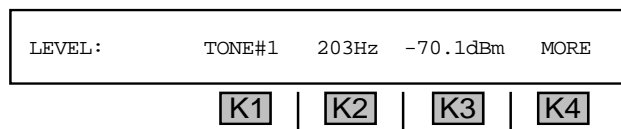
---

To view the **23 tones test results**:

1. Press **K4** under **RESULTS** from the main display. The new display reads:



2. Press **K2** under **NEAR** to view the near end results, or **K3** under **FAR** to view the far end results. The first results display reads:



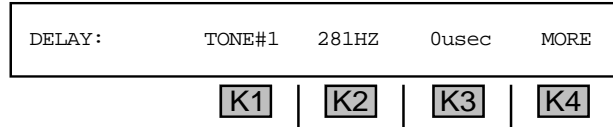
3. Press **K1** or use the **Up Arrow** key to increment the tone number. Press **K2** or use the **Down Arrow** key to decrement the tone number.

Option Menu #: 70

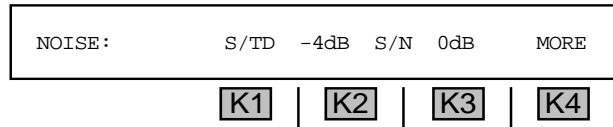
## Section V Option Menu Numbers

---

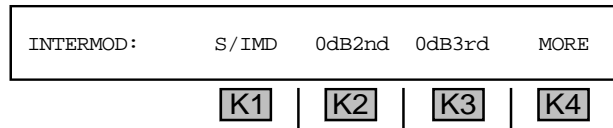
4. Press **K4** under **MORE** to advance to the **DELAY** display and view the results of the **Envelope Delay Distortion** measurement. The display reads:



5. Press **K1** or use the **Up Arrow** key to increment the tone number. Press **K2** or use the **Down Arrow** key to decrement the tone number.
6. Press **softkey 4** under **MORE** to advance to the **NOISE** display and view the results of the **Signal-to-Noise Ratio (S/N)** and **Signal-to total-Distortion (S/TD)** measurements. The display reads:



7. Press **K4** to advance to the **INTERMOD** display and view the results of the **Intermodulation Distortion (IMD)** measurement. The display reads:



The second order **IMD** product is displayed above **K2**, and the third order product is displayed above **K3**.

8. Press the **Option Menu** function key to return to the main display.

### 5-70.3.1 Print

---

You may connect a printer or computer to the **935AT** and view the results via terminal or printout. (Refer to **Section 6, Remote Control Operation** for instructions on connecting a printer or computer and **Section 6-4.4 Printing Test Results** for instructions on the print function.)

To print **23 tones test** results:

1. Press **K4** under **PRINT**. The message **--PRINTING--** will appear on the display as the **935AT** sends the results to be printed.

## 5-71 OPTION MENU #: 71 23 TONES TEST

**OPTION MENU #: 71 23 TONES TEST** is available only when *Purchase Option 935AT-100, Fax/Modem TIMS Package* is installed. This feature enables you to make a variety of transmission impairment measurements across the full channel spectrum in a short period of time.

The test signal consists of 23 equally spaced, phase coherent tones ranging from 203 Hz to 3228 Hz. The phase relationships of the tones create a signal that simulates the probability density of high speed modems such as V.29, V.32, and V.34. A single burst of 23 tones lasting only three seconds can yield multiple measurements:

- **Attenuation Distortion** at 23 frequencies
- **Envelope Delay Distortion (EDD)** at 22 frequencies
- **Signal to Total Distortion Ratio (S/TD)**
- Second and Third Order **Intermodulation Distortion (IMD)**

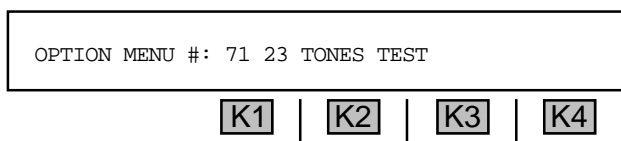
In addition, some of the measurements that correspond to conventional impairments tests have capabilities not available with traditional techniques:

- **Two wire EDD** is measured immediately without a return path.
- The **23-Tone S/TD** measurement uses a complex signal that stresses the channel much better than a single tone and intermodulation products are included in the reading.
- **ADPCM detection**: the complexity of the **23-Tone** signal causes channels that use signal compression to exhibit a characteristically high **S/TD** ratio.

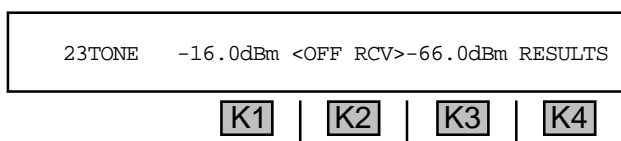
4-wire measurements can be made through a loopback, while 2-wire measurements require a repeater at the far end. The far end repeater can be provided as a responder option.

To use the **23 tones** test feature:

1. Press the **Option Menu** function key.
2. Use the **Up/Down Arrow** keys to scroll through the option menus, **OR** select **61** using the **numeric keypad** and press the **Option Menu** function key. The display reads:



3. Press **ENT** or any softkey (**K1-K4**) to activate your selection. The display reads:



## Section V Option Menu Numbers

### 5-71.1 Setup

To set up a **23 tones test**:

1. Use the **numeric keypad** to change the level of the send tone.

- A valid **send tone level** is between **-60.0 dBm** and **0.0 dBm**. This is the sum of each tone level. All 23 tones are each 13.6 dB below this level.

2. Press **K2** to toggle **SND** 23-tone on/off. The send 23-tone level is displayed above **K1**.

The **935AT** automatically performs the 23 tones test when you finish selecting your test parameters.

### 5-71.2 View

To view the **23 tones test** results:

1. Press **K4** under **RESULTS** to advance to the measurement results.

**Attenuation Distortion** is caused by a reduction in power level due to line resistance, leakages, induction, etc., resulting in the received signal being lower in volume than the original signal.

The **LEVEL** display reads:

LEVEL:	TONE#1	203Hz	-70.1dBm	MORE
<b>K1</b>	<b>K2</b>	<b>K3</b>	<b>K4</b>	

2. Press **K1** or use the **Up Arrow** key to increment the tone number **OR** press **K2** or use the **Down Arrow** key to decrement the tone number.
3. Press **K4** under **MORE** to advance to the **DELAY** display and view the results of the **Envelope Delay Distortion** measurement.

**Envelope Delay Distortion (EDD)** results when different frequencies travelling along a circuit arrive at different times, even though the frequencies were transmitted together. This occurs when the rate of change of phase shift with frequency over the bandwidth of interest is not constant. **EDD** measurements are usually stated as one-half the difference between the delays of the two frequency extremes of the band of interest.

The **DELAY** display reads:

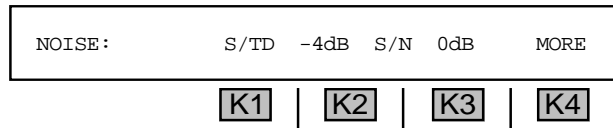
DELAY:	TONE#1	281HZ	0usec	MORE
<b>K1</b>	<b>K2</b>	<b>K3</b>	<b>K4</b>	

- Press **K1** or use the **Up Arrow** key to increment the tone number. Press **K2** or use the **Down Arrow** key to decrement the tone number.
- Press **K4** under **MORE** to advance to the **NOISE** display and view the results of the **Signal-to-Noise Ratio** and **Signal-to-Total-Distortion** measurements.

**Signal to Noise Ratio (S/N)** is the ratio of the amplitude of the desired signal to the amplitude of noise at a single point in time.

**Signal to Total Distortion (S/TD)** is the ratio of the amplitude of the desired signal to the amplitude of all forms of distortion, including noise, at a single point in time.

The **NOISE** display reads:

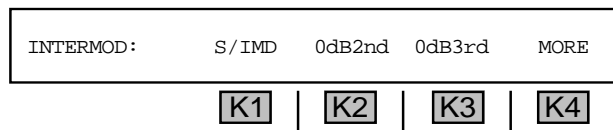


The Signal-to-Total-Distortion Ratio (**S/TD**) is displayed above **K2**, and the Signal-to-Noise Ratio (**S/N**) is displayed above **K3**.

- Press **K4** to advance to the **INTERMOD** display and view the results of the **Intermodulation Distortion** measurement.

**Intermodulation Distortion (IMD)** is a form of nonlinear distortion caused by two or more waves passing through a nonlinear device such as an amplifier, modulator, demodulator, or switch. The frequencies produced are the sum and difference products of the input frequencies and their harmonics. In **PCM**, this distortion is caused by the quantizing process, which uses the logarithmic compression law to provide more steps per volt for small speech signals than for large samples.

The **INTERMOD** display reads:



The second order **IMD** product is displayed above **K2**, and the third order product is displayed above **K3**.

- Press the **Option Menu** function key to return to the main display.

## Section V Option Menu Numbers

---

### 5-72 OPTION MENU # 72 SS-7 LEVEL 2 ANALYSIS

---

**5-72 OPTION MENU # 72 SS-7 LEVEL 2 ANALYSIS** is available only when *Purchase Option 935AT-210, SS-7 Call Trace and Error Analysis* is installed. This feature provides the **935AT** with **level 2 SS-7** monitoring capability. It can monitor four **PCM** trunks simultaneously for **SS-7** signaling errors. These errors include:

Errored SUs	Total SUs
LinkStatus SUs	Message signal units
Fill-in SUs	Percent Utilization
Retransmissions	Elapsed Time
Errored Seconds	Percent Errored Seconds

To enter the **SS-7 level 2 analysis** function:

1. Press the **Option Menu** function key.
2. Use the **Up/Down Arrow** keys to scroll through the option menus, **OR** select **72** using the **numeric keypad** and press the **Option Menu** function key. The display reads:

```
OPTION MENU #: 72 SS-7 LEVEL 2 ANALYSIS
K1 | K2 | K3 | K4
```

3. Press **ENT** or any softkey (**K1-K4**) to activate your selection. The display reads:

```
SELECT:      SETUP  TEST  HISTORY  EXIT
K1 | K2 | K3 | K4
```

#### 5-72.1 Setup

---

To **set up** the **935AT** to provide **SS-7 monitoring**:

1. Press **K1** under **SETUP**. The display reads:

```
SETUP:      PCM  PROTOCOL  EXIT
K1 | K2 | K3 | K4
```

2. Press **K1** under **PCM**. The display reads:

```
DEFAULT ALL TO AUTO?      YES  NO
K1 | K2 | K3 | K4
```



- Press **K3** under **YES** to set all **PCM** spans to the same default parameters, **OR** press **K4** under **NO** to manually set each of the **PCM** spans to different settings.

Selecting **YES** from the previous display enables you to set all **PCM** spans (**PCM1-PCM4**) to the same default setup parameters, or set some spans to the default parameters while customizing others. Selecting **NO** enables you to customize the setup parameters for each **PCM** span separately.

If **YES** was selected, the display reads:

PCM SETUP FOR:	ALL	CONTINUE	EXIT
<b>K1</b>	<b>K2</b>	<b>K3</b>	<b>K4</b>

The message **ALL** above **K2** is replaced by **PCM1** if **NO** was selected.

- Press **K2** to scroll through the available interfaces, which include: **ALL**, **PCM1**, **PCM2**, **PCM3**, and **PCM4**.
- Press **K3** to advance into the setup display for the interface shown above **K2**. The display reads:

(??) ENABLED:	YES	NO	EXIT
<b>K1</b>	<b>K2</b>	<b>K3</b>	<b>K4</b>

(??) is replaced by **ALL**, **PCM1**, **PCM2**, **PCM3**, or **PCM4** in the display, depending on the span chosen.

- Press **K2** to enable the interface, or **K3** to disable it. The default is **ENABLED**. If you selected **NO**, you will be returned to the previous display. If you selected **YES**, you will advance to the **CHANNEL** display:

(??) CHANNEL:	AUTO	EXIT
<b>K1</b>	<b>K2</b>	<b>K3</b>
<b>K4</b>		

- Press **K2** to select auto channel detect. The display reads:

(??) CHANNEL:	AUTO	EXIT
<b>K1</b>	<b>K2</b>	<b>K3</b>
<b>K4</b>		

- Press **K2** to select the currently displayed channel.
- Use the **numeric keypad** to change the channel.

## Section V Option Menu Numbers

---

10. Press **K3** to select auto channel detection. You will advance to the **FRAMING** display:

(??) FRAM:	AUTO	ESF	D4/SF	EXIT
<b>K1</b>	<b>K2</b>	<b>K3</b>	<b>K4</b>	

11. Press **K1** to select **AUTO** framing, **K2** to select **ESF**, or **K3** to select **D4/SF**. You will advance to the data **RATE** display:

(??) RATE:	AUTO	56KB	64KB	EXIT
<b>K1</b>	<b>K2</b>	<b>K3</b>	<b>K4</b>	

12. Press **K1** to select **AUTO** data rate detect, **K2** to select **56 kb** rate detect, or **K3** to select **64KB** rate detect. You will advance to the **IMPEDANCE** display:

(??) IMPEDANCE:	100 OHM	>1K OHM	EXIT
<b>K1</b>	<b>K2</b>	<b>K3</b>	<b>K4</b>

13. Press **K2** to select **100 OHM** impedance or **K3** to select **>1K OHM** impedance.

14. Press **K4** twice to return to the main **SETUP** display.

### 5-72.1.1 Selecting a Protocol

---

To select a testing protocol:

1. Press **K2** from the main display. The **PROTOCOL** display reads:

PROTOCOL:	BELLCORE	EXIT	
<b>K1</b>	<b>K2</b>	<b>K3</b>	<b>K4</b>

2. Press **K1** or **K2** under **BELLCORE** to scroll through available protocols.

At this time, only the **BELLCORE** protocol is available.

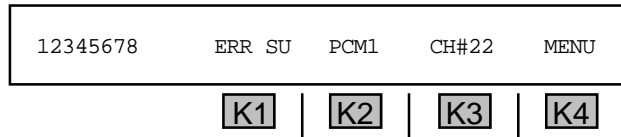
3. Press **K4** to exit to the main display.

**5-72.2 Test**

---

To begin an **SS-7** measurement:

1. Press **K2** under **TEST** from the main display. The **935AT** begins testing then displays the first test results:



2. Press the **Up/Down Arrow** keys to scroll through the error results shown on the far left of the display.

If the link is not operating normally, the measurement is replaced by one of the following link status messages:

<b>NO PCM</b>	Carrier Loss
<b>FRAME LOSS</b>	Frame Loss
<b>YELLOW ALARM</b>	Yellow alarm received and no SS-7 SUs
<b>NO SS7</b>	No SS-7 signal units on selected channel
<b>OUT OF ALIGN</b>	Link out of alignment
<b>NORMAL ALIGN</b>	Link in normal alignment procedure
<b>EMERG ALIGN</b>	Link in emergency alignment
<b>OUT OF SERV</b>	Link out of service
<b>PROCESSOR OUT</b>	Processor out of service
<b>LINK FLOW CTRL</b>	Level 2 flow control

Option Menu #: 72

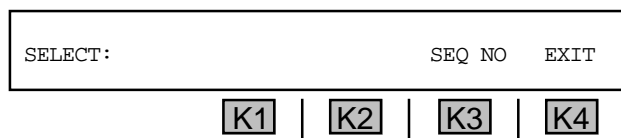
The status field above **K1** displays the error type. The following is a list of error types:

<b>ERR SU</b>	Errored SUs	<b>TOT SU</b>	Total SUs
<b>LSSU</b>	LinkStatus SUs	<b>MSU</b>	Message signal units
<b>FISU</b>	Fill-in SUs	<b>% UTIL</b>	Percent Utilization
<b>RETRNS</b>	Retransmissions	<b>ELAPSED</b>	Elapsed Time
<b>ES</b>	Errored Seconds	<b>% ES</b>	Percent Errored Seconds

3. The status field above **K2** displays the span carrying the link on which the errors are being received (**PCM1**, **PCM2**, **PCM3**, **PCM4**). Press **K2** to toggle between the two spans.

The status field above **K3** displays the channel monitored on the **DS1**.

4. Press **K4** under **MENU**. The display reads:



## Section V Option Menu Numbers

5. Press **K3** under **SEQ NO** to display the forward and backward sequence numbers and indicator bits in a live format.

*for example:*

PCM1: FSN:122 FIB:0 BSMN:102 BIB:1 EXIT				
<table style="margin: auto; border-collapse: collapse;"> <tr> <td style="border: 1px solid black; padding: 2px 10px;">K1</td> <td style="border: 1px solid black; padding: 2px 10px;">K2</td> <td style="border: 1px solid black; padding: 2px 10px;">K3</td> <td style="border: 1px solid black; padding: 2px 10px;">K4</td> </tr> </table>	K1	K2	K3	K4
K1	K2	K3	K4	

6. Press **K1** to toggle between **PCM1**, **PCM2**, **PCM3**, and **PCM4**.

### 5-72.3 Level 2 History

The history feature collects the error history over a 24 hour period in 96 fifteen-minute blocks. This history can be viewed or printed.

To enter the **error history** function:

Press **K3** from the main display. The **HISTORY** display reads:

SS7 L2 HISTORY: VIEW PRINT EXIT				
<table style="margin: auto; border-collapse: collapse;"> <tr> <td style="border: 1px solid black; padding: 2px 10px;">K1</td> <td style="border: 1px solid black; padding: 2px 10px;">K2</td> <td style="border: 1px solid black; padding: 2px 10px;">K3</td> <td style="border: 1px solid black; padding: 2px 10px;">K4</td> </tr> </table>	K1	K2	K3	K4
K1	K2	K3	K4	

#### 5-72.3.1 Viewing Level 2 Histories

To view the **error history**:

1. Press **K2** from the **HISTORY** display. The **VIEW** display reads:

12345678 ERR SU PCM1 BLK:96 11:22:33				
<table style="margin: auto; border-collapse: collapse;"> <tr> <td style="border: 1px solid black; padding: 2px 10px;">K1</td> <td style="border: 1px solid black; padding: 2px 10px;">K2</td> <td style="border: 1px solid black; padding: 2px 10px;">K3</td> <td style="border: 1px solid black; padding: 2px 10px;">K4</td> </tr> </table>	K1	K2	K3	K4
K1	K2	K3	K4	

The status field above **K1** displays the error type. The following is a list of error types:

<b>ERR SU</b>	Errored SUs	<b>TOT SU</b>	Total SUs
<b>LSSU</b>	LinkStatus SUs	<b>MSU</b>	Message signal units
<b>FISU</b>	Fill-in SUs	<b>% UTIL</b>	Percent Utilization
<b>RETRNS</b>	Retransmissions	<b>ELAPSED</b>	Elapsed Time
<b>ES</b>	Errored Seconds	<b>% ES</b>	Percent Errored Seconds

2. Press the **Up/Down Arrow** keys to scroll through the error results shown on the far left of the display.

3. The field above **K2** displays the span carrying the link on which the errors are being received (**PCM1**, **PCM2**, **PCM3**, or **PCM4**). Press **K2** to toggle between the two spans.
4. The field above **K3** displays the number of the 15 minute time block being viewed. Press **K3** to increment through the blocks, **OR** use the numeric keypad to enter a block number directly. Only blocks with valid data are displayed.

The status field above **K4** displays the start time of the block if it is not the current block, otherwise, it shows the current time.

### 5-72.3.2 Printing Level 2 Histories

---

You may connect a printer or computer to the **935AT** and view the results via terminal or printout. (Refer to **Section 6, Remote Control Operation** for instructions on connecting a printer or computer and **Section 6-4.4 Printing Test Results** for instructions on the print function.)

## Section V Option Menu Numbers

---

### 5-73 OPTION MENU # 73 SS-7 CALL TRACE

---

**OPTION MENU # 73 SS-7 CALL TRACE** is available only when *Purchase Option 935AT-210, SS-7 Call Trace and Error Analysis* is installed. This function enables you to trap on:

- **Calling Numbers** (Up to 5 numbers set with wildcards)
- **Called Numbers** (Up to 5 numbers set with wildcards)
- **Destination Point Code (DPC)** (one number can be set, wildcards are excepted)
- **Origination Point Code (OPC)** (one number can be set, wildcards are excepted)
- **Circuit Identification Code (CIC)**
- **Carrier Identification (CRC-ID)**

This function also allows you to trap on the following signaling messages at the T1 board:

- **Address Complete Message (ACM)**
- **Answer Message (ANM)**
- **Initial Address Message (IAM)**
- **Release Message (REL)**
- **Release Complete Message (RLC)**

To access the **SS-7 call trace** feature:

1. Press the **Option Menu** function key.
2. Press the **Up/Down Arrow** keys to scroll through the option menus, **OR** select **73** using the **numeric keypad** and press the **Option Menu** function key. The display reads:

OPTION MENU #: 73 SS-7 CALL TRACE
-----------------------------------

K1	K2	K3	K4
----	----	----	----

3. Press **ENT** or any softkey (**K1-K4**) to enter the **SELECT** display. The display reads:

SELECT:	SETUP	TEST	REVIEW	EXIT
---------	-------	------	--------	------

K1	K2	K3	K4
----	----	----	----

#### 5-73.1 Setup

---

To set up the **SS-7 call trace** feature:

Press **K1** under **SET-UP**. The display reads:

SETUP:	PCM	TRAPS	CONFIG	EXIT
--------	-----	-------	--------	------

K1	K2	K3	K4
----	----	----	----

### 5-73.1.1 PCM Configuration

To setup **PCM** mode:

1. Press **K1** from the **SETUP** display. The main **PCM** display reads:

DEFAULT ALL TO AUTO?	YES	NO
<b>K1</b>	<b>K2</b>	<b>K3</b>   <b>K4</b>

2. Press **K3** to default all interfaces to **AUTO** OR **K4** to customize the interface setups.

Selecting **YES** from the previous display enables you to set all **PCM** spans (**PCM1-PCM4**) to the same default setup parameters, or set some spans to the default parameters while customizing others. Selecting **NO** enables you to customize the setup parameters for each **PCM** span separately.

If you selected **YES**, the display advances to:

PCM SETUP FOR:	ALL	CONTINUE	EXIT
<b>K1</b>	<b>K2</b>	<b>K3</b>	<b>K4</b>

**ALL** above **K2** is replaced by **PCM1** if **NO** was selected.

3. Press **K2** to scroll through the available interfaces, which include: **ALL**, **PCM1**, **PCM2**, **PCM3**, and **PCM4**.
4. Press **K3** to advance to the setup display for the interface shown above **K2**. The display reads:

(??) ENABLED:	YES	NO	EXIT
<b>K1</b>	<b>K2</b>	<b>K3</b>	<b>K4</b>

(??) is replaced by **ALL**, **PCM1**, **PCM2**, **PCM3**, or **PCM4** in the display, depending on the span chosen.

5. Press **K2** to enable the interface, or **K3** to disable it. The default is **ENABLED**. If you selected **YES**, you will advance to the **CHANNEL** display:

(??) CHANNEL:	AUTO	EXIT
<b>K1</b>	<b>K2</b>	<b>K3</b>   <b>K4</b>

## Section V Option Menu Numbers

---

6. Press **K2** to select auto channel detect. The display reads:

(??) CHANNEL:	22	AUTO?	EXIT
<b>K1</b>	<b>K2</b>	<b>K3</b>	<b>K4</b>

7. Press **K2** to change the currently displayed channel.  
8. Use the **numeric keypad** to enter a new channel.  
9. Press **K3** to select auto channel detection. You will advance to the **FRAMING** display:

(??) FRAM:	AUTO	ESF	D4/SF	EXIT
<b>K1</b>	<b>K2</b>	<b>K3</b>	<b>K4</b>	

10. Press **K1** to select **AUTO** framing, **K2** to select **ESF**, or **K3** to select **D4/SF**. You will advance to the data **RATE** display:

(??) RATE:	AUTO	56KB	64KB	EXIT
<b>K1</b>	<b>K2</b>	<b>K3</b>	<b>K4</b>	

11. Press **K1** to select **AUTO** data rate detect, **K2** to select **56 kb** rate detect, or **K3** to select **64KB** rate detect. You will advance to the **IMPEDANCE** display:

(??) IMPEDANCE:	100 OHM	>1K OHM	EXIT
<b>K1</b>	<b>K2</b>	<b>K3</b>	<b>K4</b>

12. Press **K2** to select **100 OHM** impedance or **K3** to select **>1K OHM** impedance.  
13. Press **K4** twice to return to the main **SETUP** display.

### 5-73.1.2 Traps

---

To set up the **traps**:

1. Press **K2** under **TRAP** from the main **SETUP** display. The new display reads:

CLEAR ALL PREVIOUS TRAPS?	YES	NO	
<b>K1</b>	<b>K2</b>	<b>K3</b>	<b>K4</b>



2. Press **K3** under **YES** to clear the traps, or **K4** under **NO** to keep existing traps. You will advance to the following display:

TRAP:	NUMBER	ROUTING	TRUNK-ID	EXIT
<b>K1</b>	<b>K2</b>	<b>K3</b>	<b>K4</b>	

### 5-73.1.2.1 Trap Numbers

To set the **calling** and **called** trap numbers:

1. Press **K1** under **NUMBER**. The display reads:

CALLING#	CALLED#	EXIT	
<b>K1</b>	<b>K2</b>	<b>K3</b>	<b>K4</b>

2. Press **K2** to change the **CALLING NUMBER** **OR** **K3** to change the **CALLED NUMBER**.

If you selected **CALLING #** the display reads:

TRAP CLG#1: XXXXXXXXX	NEXT	EXIT	
<b>K1</b>	<b>K2</b>	<b>K3</b>	<b>K4</b>

If you selected **CALLED #** the display reads:

TRAP CLD#1: XXXXXXXXX	NEXT	EXIT	
<b>K1</b>	<b>K2</b>	<b>K3</b>	<b>K4</b>

3. Use the **numeric keypad** to enter number and press **ENT**. The position of the number and wildcards (**x**) is important. For example, **xx9xxxxxxx** will get all numbers with a 9 as a third digit, followed by any seven digits.
4. Press **K3** to advance to the next number.
5. Press **K4** to exit to the main **TRAP** display.

### 5-73.1.2.2 Trap Routing Parameters

To set the **routing origin** and **destination**:

1. Press **K2** from the main **TRAP** display.

## Section V Option Menu Numbers

---

The new display reads:

ROUTING:	ORIGIN	DESTINATION	EXIT
<input type="button" value="K1"/>	<input type="button" value="K2"/>	<input type="button" value="K3"/>	<input type="button" value="K4"/>

2. Press **K1** to change the **ORIGIN** trap **OR K3** to change the **DESTINATION** trap.

If you choose **ORIGIN**, the display reads:

OPC:	XXX-XXX-XXX	EXIT	
<input type="button" value="K1"/>	<input type="button" value="K2"/>	<input type="button" value="K3"/>	<input type="button" value="K4"/>

If you choose **DESTINATION**, the display reads:

DPC:	XXX-XXX-XXX	EXIT	
<input type="button" value="K1"/>	<input type="button" value="K2"/>	<input type="button" value="K3"/>	<input type="button" value="K4"/>

3. Use the **numeric keypad** to enter the new trap number.
4. Press **K4** to **EXIT** to the main **ROUTING** display.

### 5-73.1.2.3 Trunk ID

---

To set up the **TRUNK ID**:

1. Press **K2** from the main **TRAP** display. The new display reads:

TRUNK ID:	CIC: XXXXX	CRX-ID: XXXX	EXIT
<input type="button" value="K1"/>	<input type="button" value="K2"/>	<input type="button" value="K3"/>	<input type="button" value="K4"/>

2. Press **K1** to change the **CIC** **OR K3** to change the **CRX-ID #**.
3. Use the **numeric keypad** to enter a new **TRUNK ID** number.
4. Press **K4** to **EXIT** to the main **TRAP** display.

### 5-73.1.3 SS-7 Configuration

To configure the 935AT for **SS-7** operation:

Press **K3** from the **SETUP** display. The new display reads:

CONFIG:	BUFFER	PROTOCOL	MSG-TYPE	EXIT
<b>K1</b>	<b>K2</b>	<b>K3</b>	<b>K4</b>	

#### 5-73.1.3.1 Buffer

To configure the **buffer**:

1. Press **K1** to configure the buffer. The display reads:

BUFFER:	STOP WHEN BUFFER FULL	EXIT	
<b>K1</b>	<b>K2</b>	<b>K3</b>	<b>K4</b>

2. Press **K1**, **K2**, or **K3** to toggle between the previous display and the following:

BUFFER:	CONT	OVERWRITE	OLDEST	EXIT
<b>K1</b>	<b>K2</b>	<b>K3</b>	<b>K4</b>	

3. Press **K4** to select the displayed message and exit to the **CONFIG** display.

#### 5-73.1.3.2 Protocol

To select a **protocol**:

1. Press **K2** under **PROTOCOL**. The display reads:

PROTOCOL:	BELLCORE	EXIT	
<b>K1</b>	<b>K2</b>	<b>K3</b>	<b>K4</b>

2. Use the **Up/Down Arrow** keys to scroll through the available protocols.
3. Press **K4** to select the displayed protocol **EXIT** to the **CONFIG** display.

**Note:** Currently, only the **Bellcore** protocol is available.

## Section V Option Menu Numbers

---

### 5-73.1.3.3 Message Type

---

To select a **message type**:

1. Press **K3** under **MSG-TYPE**. The display reads:

MSG-TYPE:	ISUP	TCAP	BOTH	EXIT
<b>K1</b>	<b>K2</b>	<b>K3</b>	<b>K4</b>	

2. Press **K1** to select **ISUP** (Integrated Services Digital Network User Part) trunking messaging, press **K2** to select **TCAP** (Transactional Capabilities Transaction Part) messaging, **OR** press **K3** to select both **ISUP** and **TCAP** messaging.
3. Press **K4** to exit to the **CONFIG** display.

### 5-73.2 Test

---

To check the setup status before testing:

1. Press **K2** under **TEST** from the main **SETUP** display. The first status display reads:

PCM1: SCANNING FOR SETUP CRITERIA			
<b>K1</b>	<b>K2</b>	<b>K3</b>	<b>K4</b>

If no carrier is detected after **5** seconds, the display changes to:

PCM1: NO CARRIER DETECTED -- DISABLED			
<b>K1</b>	<b>K2</b>	<b>K3</b>	<b>K4</b>

The display will then advance to the next interface type.

If no **SS-7** is detected after **5** seconds, the display advances to:

PCM1: NO SS7 DETECTED --	SET	DISABLE	
<b>K1</b>	<b>K2</b>	<b>K3</b>	<b>K4</b>

2. Press **K3** to set the parameters for the displayed interface **OR K4** to disable the interface and advance to the next interface. If you choose to set the parameters, the display reads:

PCM1:	ESF	CHAN:--	--	CONTINUE
<b>K1</b>	<b>K2</b>	<b>K3</b>	<b>K4</b>	

3. Press **K1** to change the framing selection. The options are: **ESF**, **AUTO** and **D4/SF**.
4. Press **K2** to change the channel.

If a channel was specified in the previous display, the new display reads:

AUTO SEARCH TO NEXT CHAN	YES	NO
<b>K1</b>	<b>K2</b>	<b>K3</b>
<b>K4</b>		

If you press **K3** under **YES**, the display reads:

PCM1:	SCANNING FOR NEXT VALID CHANNEL
<b>K1</b>	<b>K2</b>
<b>K3</b>	<b>K4</b>

If you press **K4** or there is no channel specified in the previous display, the next display reads:

ENTER NEW CHANNEL NUMBER	22	CONT
<b>K1</b>	<b>K2</b>	<b>K3</b>
<b>K4</b>		

You can then use the **numeric keypad** to enter a new channel number.

5. Upon completion of the setup for an interface, you will be returned to the second setup display to repeat the procedure for the remaining interfaces.
6. The SS-7 test will begin automatically when the setup is completed. During testing, the display increments through a series of test results at **5** second intervals.

If you selected **ISUP** messaging, the results are:

<b>IAM</b>	<b>CIC</b>	Initial Address Message Circuit ID Code	<b>ACM</b>	<b>CIC</b>	Answer Complete Message Circuit ID Code
<b>CLG#</b>		Calling Number	<b>ANM</b>	<b>CIC</b>	Answer Message Circuit ID Code
<b>CLD#</b>		Called Number	<b>RLS</b>	<b>CIC</b>	Release Circuit ID Code
<b>OPC</b>		Originating Point Code	<b>RLS</b>		Release
<b>DPC</b>		Destination Point Code	<b>RLC</b>	<b>CIC</b>	Release Complete Message Circuit ID Code
<b>CRX</b>		Carrier ID			

## Section V Option Menu Numbers

---

If you selected **TCAP** messaging, the results are:

<b>T ID</b> TCAP ID	<b>LATA#</b> Local Transport and Transport Area #
<b>TCLG#</b> TCAP Calling #	<b>TRET#</b> TCAP Return #
<b>TCLD#</b> TCAP Called #	<b>TCRX#</b> TCAP Carrier ID#
<b>TOPC</b> TCAP Originating Point Code	
<b>TDPC</b> TCAP Destination Point Code	

If you selected **BOTH** messaging types, use the **Left/Right Arrow** keys to toggle between the **ISUP** and **TCAP** displays.

7. Use the **Up Arrow** key or any softkey (**K1-K4**) to increment through the test displays, or use the **Down Arrow** key to decrement through the tests.
8. Press the **Option Menu** function key to exit to the **SELECT** display.

### 5-73.3 Review

---

To review **test results**:

Press **K3** under **REVIEW** from the **SELECT** display. The **REVIEW** display reads:

REVIEW:	LEVEL-1	LEVEL-2	TRACE	EXIT
<b>K1</b>	<b>K2</b>	<b>K3</b>	<b>K4</b>	

#### 5-73.3.1 View Level-1 History

---

To view the **level-1 history** (PCM data):

1. Press **K1** under **LEVEL-1**. The **LEVEL-1** display reads:

LEVEL-1 HISTORY:	VIEW	PRINT	EXIT
<b>K1</b>	<b>K2</b>	<b>K3</b>	<b>K4</b>

2. Press **K2** under **VIEW**. The display reads:

-----	BPV	ERRS	PCM1	---:---:---	EXIT
<b>K1</b>	<b>K2</b>	<b>K3</b>	<b>K4</b>		

3. Press **K1** under **BPV ERRS** to scroll through the error types listed below:

<b>BPV ERRS</b>	<b>BPV RATE</b>	<b>CRC/FRM</b>	<b>ERRORS</b>
<b>BIT SLIP</b>	<b>FR SLIP</b>	<b>FR LOSS</b>	<b>NO PCM</b>
<b>EFS</b>	<b>%EFS ES</b>	<b>ES</b>	<b>%ES</b>
<b>SES</b>	<b>%SES</b>	<b>FAILED</b>	<b>%FAILED</b>
<b>AVAIL</b>	<b>%AVAIL</b>	<b>UNAVAIL</b>	<b>%UNAVAIL</b>

4. Press **K2** to scroll through the available **PCM** interfaces listed below:

<b>PCM1</b>	<b>PCM2</b>	<b>PCM3</b>	<b>PCM4</b>
-------------	-------------	-------------	-------------

5. Press **K3** to change the elapsed time format from **24 hour clock** to **elapsed sec display**.
6. Press **ENT** if you are in **COMPUTER** or **PRINTER** mode to print out the current totals.

### 5-73.3.2 View Level-2 History

To view the **level-2 history** (SS-7 error data):

1. Press **K2** under **LEVEL-2** from the **SELECT** display. The **LEVEL-2** display reads:

LEVEL-2 HISTORY:	VIEW	PRINT	EXIT
<b>K1</b>	<b>K2</b>	<b>K3</b>	<b>K4</b>

2. Press **K1** under **VIEW**. The display reads:

12345678	ERRS SU	EXIT	
<b>K1</b>	<b>K2</b>	<b>K3</b>	<b>K4</b>

3. Press **K1** under **ERR SU** to scroll through the available error types listed below:

<b>ERR SU</b>	<b>LSSU</b>	<b>FISU</b>	<b>RETRNS</b>
<b>ES</b>	<b>%ES</b>	<b>TOT SU</b>	<b>MSU</b>
<b>%UTIL</b>	<b>SU ERM</b>	<b>AERM</b>	<b>ELAPSED</b>

4. Press **K2** under **PCM1** to scroll through the available PCM interfaces (**PCM1-PCM4**).
5. Press **K3** to view the results of the currently selected interface. The display reads:

PCM1:	FSN:xxx	FIB:x	BSN:xxx	BIB:x	EXIT
<b>K1</b>	<b>K2</b>	<b>K3</b>	<b>K4</b>		

## Section V Option Menu Numbers

---

6. Press **K1** or the **Up Arrow** to increment the interface or the **Down Arrow** key to decrement the interface.
7. Press **K4** to exit back to the previous display.

### 5-73.3.3 Print Level-1 and Level-2 Histories

---

You may connect a printer or computer to the **935AT** and view the results via terminal or printout. (Refer to **Section 6, Remote Control Operation** for instructions on connecting a printer or computer and **Section 6-4.4 Printing Test Results** for instructions on the print function.)

### 5-73.3.4 Call Trace History

---

To use the **call trace history** feature:

Press **K3** under **TRACE** from the **REVIEW** display. The **CALL TRACE** display reads:

CALL TRACE HIST:	VIEW	PRINT	EXIT
<b>K1</b>	<b>K2</b>	<b>K3</b>	<b>K4</b>

#### 5-73.3.4.1 View

---

To view the **call trace history**:

1. Press **K2** under **VIEW**. The display reads:

---:---:---.---	R: 223	IAM	CIC:-----
<b>K1</b>	<b>K2</b>	<b>K3</b>	<b>K4</b>

If you selected **ISUP** messaging, the result displays are:

<b>IAM</b>	<b>CIC</b>	Initial Address Message Circuit ID Code	<b>DPC</b>	Destination Point Code
<b>OPC</b>		Originating Point Code	<b>CLD#</b>	Called #
<b>ANM</b>		Answer Message	<b>ACM</b>	Answer complete Message
<b>RLC</b>		Release Complete	<b>RLS</b>	Release Cause
<b>CLG#</b>		Calling #		



If you selected **TCAP** messaging, the result displays are:

<b>TID#</b> TCAP ID#	<b>TDPC</b> TCAP Destination Point Code
<b>TOPC</b> TCA Originating Point Code	<b>TCRX#</b> TCAP Carrier ID
<b>TRET#</b> TCAP Return #	<b>TCLD#</b> TCAP Called #
<b>TCLG#</b> TCAP Calling #	<b>LATA#</b> Local Transport and Transport Area #

2. Press **K1** to increment the record number or use the **numeric keypad** to input the desired record number directly.
3. Press any softkey (**K1-K4**) to scroll through the decode.
4. Press **ENT** if you are in **COMPUTER** or **PRINTER** mode to print out the current totals.

---

#### **5-73.3.4.2 Print**

To print **call trace histories**:

1. Press **K2** under **PRINT** from the **CALL TRACE** display.
2. Refer to **Section 6-4, Printer mode** for instructions on using the print function.

## Section V Option Menu Numbers

---

### 5-75 OPTION MENU #: 75 REMOTE UPGRADE

---

**OPTION MENU #: 75 REMOTE UPGRADE** is a standard feature that you can use to download software to the **935AT**. You can download software in one of two ways:

- From a computer connected directly to the **RS-232** port on the **935AT**.
- From Sage instruments or a remote terminal using a dial-up connection.

**Note:** The **935AT** must be in **COMPUTER** or **TERMINAL** remote mode to use this option. (Refer to **SECTION 5-3, OPTION MENU #:3 REMOTE CONTROL** for setup information.)

#### 5-75.1 Installing Sage Software Upgrade Files on a Hard Disk

---

This procedure enables you to copy the Sage software upgrade files from the diskette to the hard disk of the computer that will be used to perform the upgrade.

To install the software upgrade to your hard drive:

1. Exit from any applications you may have been running on the computer.
2. Go to the **C: prompt**.
3. Type **md tempy**. This command will create a temporary subdirectory so you can copy the files from the upgrade diskette to the computer's hard disk.
4. Type **cd tempy**
5. Insert the software upgrade diskette into the PC's floppy disk drive.
6. Type **copy a:\*.\* c:\tempy**. This will copy all the files on the diskette to the **tempy** directory.
7. Type **c:install** and press the **RETURN** key. You will be prompted for the PC "COM" port (serial port) number with a display similar to the following: **Select COM: port #[1,2,3,4]?**
8. Type the computer's **COM** port number (typically **1** or **2**) that is connected to the **935AT RS-232** port, or the modem that will be used to dial the **935AT**.
9. The installation program prompts you to select the data transmission baud rate:

**Select BAUD rate: 1=38400 2=19200 3=9600 4=2400 5=1200**

Type the number corresponding to the baud rate you want to use.

**Hint:** With the typical dial-up connection, **9600** baud tends to provide the fastest reliable transmission, although the **935AT** does support **19200**. (Sage Instruments does not currently support modem download at **38400**.) When the computer is connected directly to the **RS-232** port on the **935AT**, use **38400**.

10. You are now prompted to confirm your selections, and are given a chance to change them.
11. Finish the downloading procedure.

If you are downloading directly from a computer, refer to steps 4 -10 in **Section 5-75.2 Downloading Software to the 935AT from a Computer**.

If you are downloading to the **935AT** remotely using a modem, refer to **Section 5-75.3 Downloading Software to the 935AT Remotely Using a Modem**.

### 5-75.2 Downloading Software to the 935AT from a Computer

This procedure allows you to download new software to the **935AT** from a computer via the **RS-232** port located on the rear panel of the **935AT** test set. To use this upgrade method, your personal computer (PC) must be equipped with a 3.5" floppy disk drive and a hard disk with 2 Mb of free disk space

To download software to the **935AT** from a computer connected directly to the **RS-232** port:

1. Connect an **RS-232** cable from the **COM1** port on your **PC** to the **RS-232** port on the rear of the **935AT**. (Refer to **Section 6, Remote Control Operation** for further information.)
2. Use **OPTION MENU #:3 REMOTE CONTROL** to setup the **935AT** for **COMPUTER** mode.
3. Follow the procedure in **Section 5-75.1 Installing Sage Software Upgrade Files on a Hard Disk**. When you finish step **11** of the procedure, you will continue the software download to the **935AT** starting on step **4** below.
4. Press the **Option Menu** function key on the **935AT**.
5. Use the **Up/Down Arrow** keys to scroll through the option menus, **OR** select **75** using the **numeric keypad** and press the **Option Menu** function key. The display reads:

OPTION MENU #: 75 REMOTE UPGRADE

**K1** | **K2** | **K3** | **K4**

6. Press **ENT** or any softkey (**K1-K4**) to activate your selection. The display reads:

REMOTE UPGRADE:                    YES                    NO

**K1** | **K2** | **K3** | **K4**

## Section V Option Menu Numbers

---

7. Press **K4** under **NO** to discontinue the upgrade process or press **K2** under **YES** to proceed. If you select **YES**, the display reads:

ARE YOU SURE?	YES	NO	
<b>K1</b>	<b>K2</b>	<b>K3</b>	<b>K4</b>

8. Press **K4** under **NO** to stop the upgrade process, **OR** press **K2** under **YES** to proceed. The **935AT** display reads: **FIRMWARE UPDATE -- WAITING FOR CONNECT**.

The **935AT** will cold-boot if it does not receive any communication within one minute.

If the downloading procedure is interrupted, turn off the **935AT**, hold down the **ENT** and **HELP** keys and turn the **935AT** on again. The **935AT** returns to the **FIRMWARE UPDATE -- WAITING FOR CONNECT** display.

9. The install program on the computer asks you if you will be using a modem:

Dialing the 930 through a modem? (y/n)

Type the letter **n**.

10. The installation program runs automatically from here. The PC downloads the software to the **935AT**. If any questions arise during the installation, they appear on the display.

### 5-75.3 Downloading Software to the 935AT Remotely Using a Modem

---

Follow this procedure to download a software upgrade remotely after completing step **12** of **Section 5-75.1 Installing Sage Software Upgrade Files on a Hard Disk**.

#### 5-75.3.1 Preparing the Equipment

---

##### Prerequisites

- Personal computer (PC) equipped with a 3.5" floppy disk drive and a hard disk with 2 Mb (megabytes) of free disk space.
- Internal or external **US Robotics Sportster Modem<sup>1</sup>** for the PC.
- Telephone line for the modem at the PC.
- Sage Instruments Model **935AT** Telecommunications Test Set.
- US Robotics Sportster Modem<sup>1</sup> for the **935AT**.
- Null modem cable to connect the modem to the **935AT**'s rear panel **DB25** serial port connector.
- Telephone line for the modem at the **935AT**.

**Note 1:** Other manufacturers' modems may be used but, due to command variations between modem brands, these instructions only assume use of a **US Robotics Sportster** Modem. If you use another manufacturer's modem, refer to your modem manual and *Tables 1 & 2* of these instructions for setup of your modem.

### 5-75.3.1.1 PC Cable Connections

---

#### For PC's using an internal modem

Plug the telephone cord into the phone line connector on the modem.

#### For PC's using an external modem

1. Connect a standard **RS-232** serial cable between the PC's **COM** port and the **DB25** connector located on the modem's rear panel.
2. Plug the phone line into the phone line connector on the modem.

#### 935AT Cable Connections

Connect a null modem **RS-232** serial cable between the modem and the **DB25** connector located on the **935AT's** rear panel.

### 5-75.3.1.2 Modem Configurations

---

#### Setting Up the 935AT

Use **Option Menu#: 3 Remote Control**, to set the **935AT** with the following settings:

- Computer Mode
- Baud Rate = 1200, 2400, 9600 or 19200 (Depends on the speed of the modem used. (19200 or 9600 is recommended for minimum download time.)
- Data Bits = 8
- Parity = None
- Stop Bits = 1

#### Setting Up the Modems

If you are using a modem type other than the **US Robotics Sportster**, you must consult the modem manufacturer's instructions and interpret the settings according to **Table 75-1**.

**Note:** Carefully refer to the section of your modem manual covering DIP switch settings to ensure you know which way is "on" and "off".

**Section V Option Menu Numbers**

Set the **DIP** switches on the **US Robotics Sportster Modems** connected to your **PC** and **935AT** according to the specifications in **Table 75-1**.

**Table 75-1 — External US Robotics Sportster DIP Switch Settings**

Switch	Factory Default	935AT Download Setting	Function
1	OFF	ON	<b>Data Terminal Ready (DTR) Override</b> OFF = Normal DTR operations: computer must provide DTR signal for modem to accept commands; dropping DTR terminates a call ON = Modem ignores DTR (Override)
2	OFF	OFF	<b>Verbal/Numeric Result Codes</b> OFF = Verbal (word) results ON = Numeric results
3	ON	OFF	<b>Result Code Display</b> OFF = Suppresses result codes ON = Enables result codes
4	OFF	ON	<b>Command Mode Local Echo Suppression</b> OFF = Displays keyboard commands ON = Suppresses echo
5	ON	ON (PC)	<b>Auto Answer Suppression</b> OFF = Modem answers on first ring, or higher if specified in NVRAM (Non-Volatile Random Access Memory) ON = Disables auto answer
6	OFF	OFF	<b>Carrier Detect (CD) Override</b> OFF = Modem sends CD signal when it connects with another modem, drops CD on disconnect ON = CD always ON (Override)
7	OFF	ON	<b>Power-on and ATZ Reset Software Defaults</b> OFF = Loads Y or Y1 configuration from user-defined nonvolatile memory (NVRAM) ON = Loads &F0 — Generic template from read only memory (ROM)
8	ON	ON	<b>AT Command Set Recognition</b> OFF = Disables command recognition (Dumb Mode)

Option Menu #: 75

### 5-75.3.2 Performing a Remote Download

---

Be sure your modems are connected and configured at the **935AT** and at the downloading computer before proceeding with this part of the software download.

To download software to the **935AT** remotely:

1. The install program will ask you if you will be using a modem:

`Dialing the 930 through a modem? (y/n)`

Answer by typing the letter **y**.

2. You will then be prompted for the dialup string with a display similar to the following:

`Enter the dialup string (Example: dt555-1122) followed by Ctrl-Z ENTER:`

Type the dialup string as instructed (Example: `dt555-1122`), followed by a **CTRL-Z**, then press **RETURN**.

- Dashes in the dial-up string are allowed, but not necessary.
- To cause a 2-second pause between dialed digits, type a comma “,” between those digits. (Example: `dt9,5551212`)
- **CTRL-Z** is a two-key sequence: Hold down the **Ctrl** key and type the letter “**Z**”.
- For transmission baud rates greater than 9600 baud, prefix the dialup string with “**&h1&b1&k2&a3**” (Example: `&h1&b1&k2&a3dt5551212`). Do *not* insert spaces between any characters preceding the “**dt**”.

3. The installation program runs automatically from here. The PC dials the phone number for the **935AT**, downloads the software update and disconnects the phone call. If any questions need to be answered during the installation, they will appear on the display.

**Section V Option Menu Numbers**

---

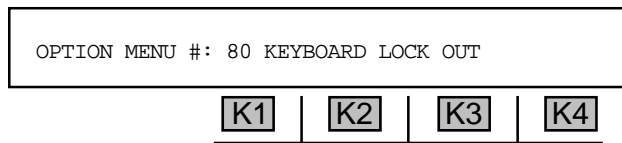
**5-80 OPTION MENU #: 80 KEYBOARD LOCK OUT**

---

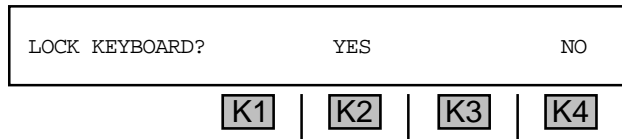
**OPTION MENU #: 80 KEYBOARD LOCK OUT** is a standard feature that enables you to lock out all keys on the **935AT** front panel. This allows only **REMOTE** mode to affect the **935AT**.

To **lock out** the **935AT** front panel:

1. Press the **Option Menu** function key.
2. Use the **Up/Down Arrow** keys to scroll through the option menus, **OR** select **80** using the **numeric keypad** and press the **Option Menu** function key. The display reads:



3. Press **ENT** or any softkey (**K1-K4**) to activate your selection. The display reads:



4. Press **K4** under **NO** to discontinue this procedure, **OR** press **K2** under **YES** to lock out all keys on the **935AT** front panel.

If any key is pressed while in the lockout state, the display reads: **KEYBOARD LOCKED! 9999 TO UNLOCK.**

5. To return the **935AT** to normal functionality, type **9999** using the **numeric keypad**.

Option Menu #:  
80

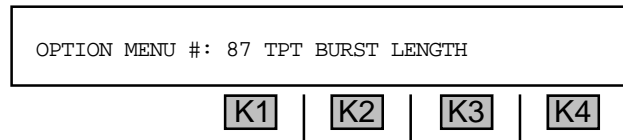


5-87 OPTION MENU #: 87 TPT BURST LENGTH

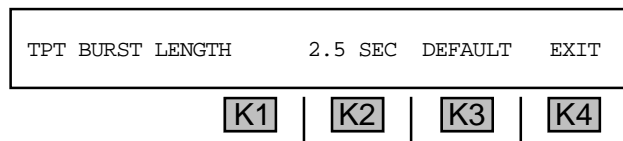
**OPTION MENU #: 87 TPT BURST LENGTH** is available only when *Purchase Option 935AT-110, Voice Circuit Test Package* is installed. This function enables you to set the length of the TPT tone sent from the **935AT** when acting as a Type 105 responder. This affects **OPTION MENU #: 25 FAR END RESPONDER** and **OPTION MENU #: 4 DIGIT RECEIVER**. This feature allows the **935AT** to be compatible with most near-end responders.

To set the **length of the TPT tone sent**:

1. Press the **Option Menu** function key.
2. Use the **Up/Down Arrow** keys to scroll through the option menus, **OR** select **87** using the **numeric keypad** and press the **Option Menu** function key. The display reads:



3. Press **ENT** or any softkey (**K1-K4**) to activate your selection. The display reads:



4. Use the **numeric keypad** to enter the burst length.

• A valid **burst length** is between **.01 sec** and **99.9 sec**. The default parameter is **2.5 sec**.

5. Press **K4** under **EXIT** or the **Option Menu** function key to exit this display.

## Section V Option Menu Numbers

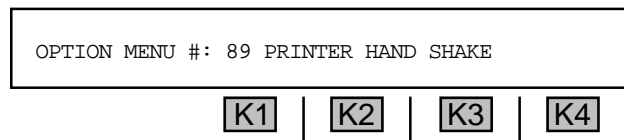
### 5-89 OPTION MENU #: 89 PRINTER HAND SHAKE

**OPTION MENU #: 89 PRINTER HAND SHAKE** is a standard feature that enables you to select a form of flow control when the **935AT** sends data to the printer. This allows the printer to tell the **935AT** to stop sending when the printer's buffer is full or the printer is off-line.

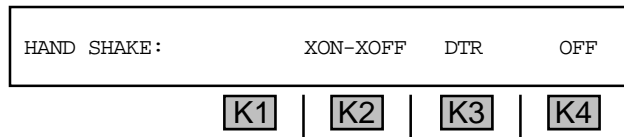
If your printer misses characters sent by the **935AT**, especially during long printouts such as digit analysis or **T1 BERT** history, select a lower baud rate or use **OPTION MENU #: 89 PRINTER HAND SHAKE** to output data more efficiently. The **935AT** supports **DTR** and **XON/XOFF** protocols.

To select a form of **flow control** when data is sent to a printer:

1. Press the **Option Menu** function key.
2. Use the **Up/Down Arrow** keys to scroll through the option menus, **OR** select **89** using the **numeric keypad** and press the **Option Menu** function key. The display reads:



3. Press **ENT** or any softkey (**K1-K4**) to activate your selection. The display reads:



The factory default is **OFF** (no hand shake).

4. Press **K2** under **XON-XOFF** to tell the **935AT** to wait for a n **XOFF** character. A cursor will appear over your selection.

**XON-XOFF** enables the **935AT** to stop sending characters to the printer when it receives the **XOFF** character (**CNTL-S**) from the printer. It will resume sending characters when it receives the **XON** character (**CNTL-Q**). **XON-XOFF** protocol is useful when communicating over modems or other media which do not allow a separate hardware hand shake, such as the **DTR** line.

5. Press **K3** to enable **DTR** handshaking. A cursor will appear over your selection.

**DTR handshaking** allows the **935AT** to send characters to the printer only when it sees positive voltage on **DTR** (pin 20). If your printer is off-line, powered down, or has a full buffer, it will not provide this voltage and the **935AT** will "hang" when attempting to print. **DTR** handshaking allows the printer to "catch up" by printing the contents of its buffer while the **935AT** waits. (The printers supplied by Sage Instruments are shipped with **DTR** handshaking enabled.)

6. Press **K4** under **OFF** to allow the **935AT** to send to any serial device.

After making your selection, you will be returned to the main display.

When the **935AT** attempts to send characters and the hand shake fails (there is no voltage on DTR or an **XOFF** character was received without an **XON**), it “hangs” until either the hand shake succeeds or **10 seconds** have passed. If **10 seconds** pass without a successful hand shake, the **935AT** turns the hand shake **OFF** and proceeds normally. If a hand shake fails because a printer is turned off or left off-line when the **935AT** needs to print, you will need to re-enable the hand shake by using **OPTION MENU #: 89 PRINTER HAND SHAKE** again. As long as the hand shake is successful, the hand shake protocol is stored in battery-backed RAM and will remain set.

## Section V Option Menu Numbers

---

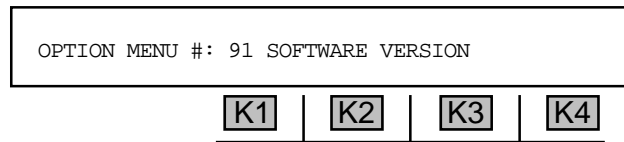
### 5-91 OPTION MENU #: 91 SOFTWARE VERSION

---

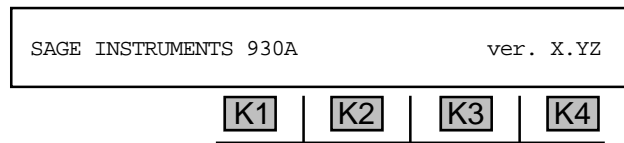
**OPTION MENU #: 91 SOFTWARE VERSION** is a standard feature that enables you to view the version of software that is currently installed on your **935AT**.

To display the **current software version**:

1. Press the **Option Menu** function key.
2. Use the **Up/Down Arrow** keys to scroll through the option menus, **OR** select **91** using the **numeric keypad** and press the **Option Menu** function key. The display reads:



3. Press **ENT** or any softkey (**K1-K4**) to activate your selection. The **935AT** will display the software version installed:



4. Press the **Option Menu** function key to exit this display.

5-92 OPTION MENU #: 92 RESET 935

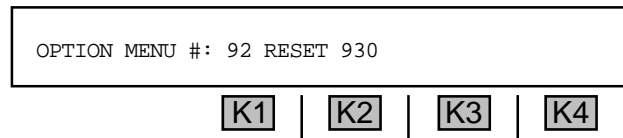
**OPTION MENU #: 92 RESET 935** is a standard feature that restores the **935AT** to its factory default settings through either a **cold** or a **warm boot**.

- A **cold boot** retains all serial I/O settings but resets everything else to the factory default parameters.
- A **warm boot** is the equivalent of turning the **935AT** off and on. It does not default the parameters.

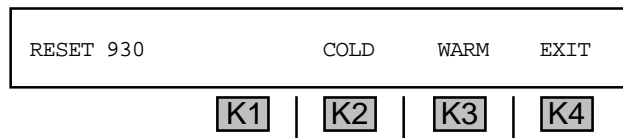
Selecting this option does not affect the Remote Control settings.

To perform a **cold or warm boot**:

1. Press the **Option Menu** function key.
2. Use the **Up/Down Arrow** keys to scroll through the option menus, **OR** select **92** using the **numeric keypad** and press the **Option Menu** function key. The display reads:

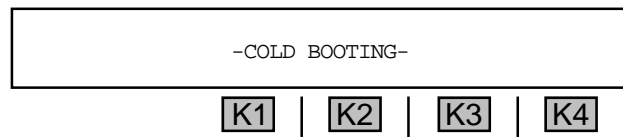


3. Press **ENT** or any softkey (**K1-K4**) to activate your selection. The display reads:



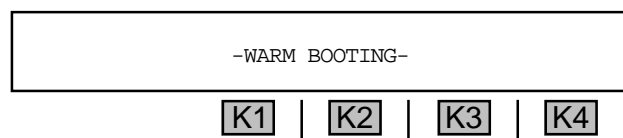
4. Press **K2** under **COLD** to cold-boot **OR** press **K3** under **WARM** to warm boot.

If you select **cold boot**, the display reads:



The display and LEDs will then run through the initial **935AT** start-up sequence.

If you select **warm boot** the display reads:



The display and LEDs will then run through the initial **935AT** start-up sequence.

Option Menu #: 92

## Section V Option Menu Numbers

---

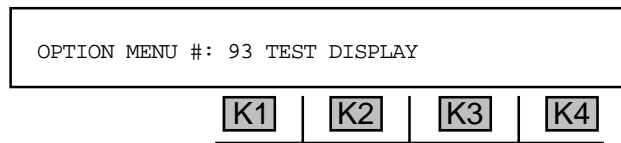
### 5-93 OPTION MENU #: 93 TEST DISPLAY

---

**OPTION MENU #: 93 TEST DISPLAY** is a standard feature that enables you to test the display and the LEDs by turning everything on.

To test the display:

1. Press the **Option Menu** function key.
2. Use the **Up/Down Arrow** keys to scroll through the option menus, **OR** select **93** using the **numeric keypad** and press the **Option Menu** function key. The display reads:



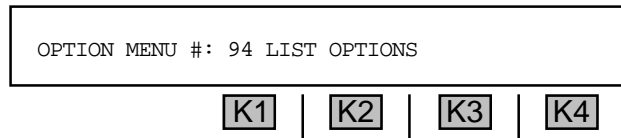
3. Press **ENT** or any softkey (**K1-K4**) and all lights and LEDs will go on.
4. Press the **Option Menu** function key to exit this test.

5-94 OPTION MENU #: 94 LIST OPTIONS

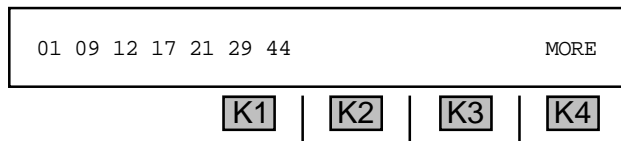
**OPTION MENU #: 94 LIST OPTIONS** is a standard feature that lists the Purchase Options that are installed on your **935AT**.

To list the **Purchase Options** installed on your **935AT**:

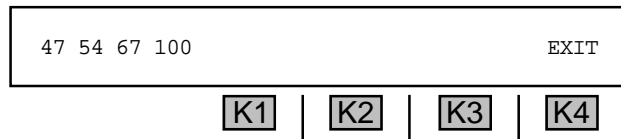
1. Press the **Option Menu** function key.
2. Use the **Up/Down Arrow** keys to scroll through the option menus, **OR** select **94** using the **numeric keypad** and press the **Option Menu** function key. The display reads:



3. Press **ENT** or any softkey (**K1-K4**) to see a display similar to:



4. Press **K4** under **MORE** to display any further Purchase Options:



5. Press **K4** under **EXIT** to return to the main display.

Refer to the following table for a list of which Option Menus correspond to each Purchase Option.

<u>Purchase Option #</u>	<u>Description</u>	<u>OPTION MENU #</u>
100	Fax/Modem TMS Package	11, 13, 17, 18, 19, 22, 69, 70, 71
110	Voice Circuit Test Package	24, 25, 26, 27, 29, 52, 53, 65, 66, 87
200	BERT Test Package	46, 55, 56, 57, 58
210	SS7 Call Trace and Error Analysis	72, 73
320	Digital Rear Panel Access	
330	Ring Generator/True REN-3 Load	5
340	Wideband TMS	
346	Extended Warranty	extends warranty to three years
347	Remote Audio Monitor	39
348	-48V DC Office Battery Power	allows for this method of power supply

Option Menu #: 94

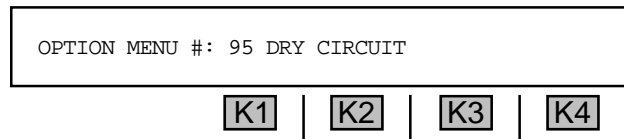
## Section V Option Menu Numbers

### 5-95 OPTION MENU #: 95 DRY CIRCUIT

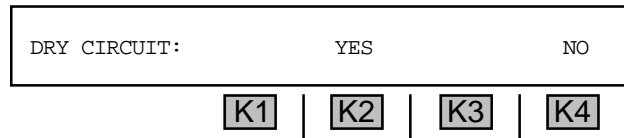
**OPTION MENU #: 95 DRY CIRCUIT** is a standard feature that puts the **935AT** in the mode that tests these circuits. The **935AT** normally expects to see supervision on the trunks it is testing. Dry circuits are trunks that have no supervision. These are usually dedicated lines found in special services point-to-point applications.

To bring the **935AT** to **dry circuit**:

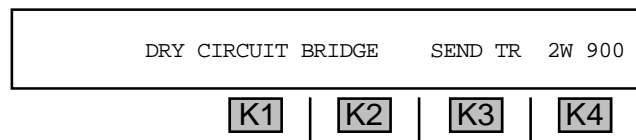
1. Press the **Option Menu** function key
2. Use the **Up/Down Arrow** keys to scroll through the option menus, **OR** select **95** using the **numeric keypad** and press the **Option Menu** function key. The display reads:



3. Press **ENT** or any softkey (**K1-K4**) to activate your selection. The display reads:



4. Press **K2** under **YES** to bring **935AT** to **Dry Circuit** mode. The display reads:



The default parameters are shown above.

5. Press **K2** to toggle **BRIDGE** to **TERM** (terminate).
6. Press **K4** to scroll through the available impedances.

- Valid **impedances** are **2W** or **4W** at **135**, **600**, **900**, or **1200 Ohms**

After setting the correct operating conditions, the **935AT** functions as it would in any other trunk type.

7. Press **K1** to exit this trunk type and remain in trunk type selection mode. Once the trunk type is changed, **Dry Circuit** mode is disabled. You must reenter this option to enable **Dry Circuit** mode again. If the trunk type selection does not change, the **935AT** remains in **Dry Circuit** mode until this option is reentered and **K4** under **NO** (disable) is selected.

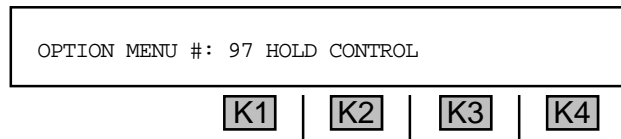


5-97 OPTION MENU #: 97 HOLD CONTROL

**OPTION MENU #: 97 HOLD CONTROL** is a standard feature that provides a path for DC current and allows the **935AT** to control one or both hold coils, or “hold the Central Office equipment up”. This may be accomplished in 4-wire normal loop, 4-wire E&M, or dry circuit trunk types.

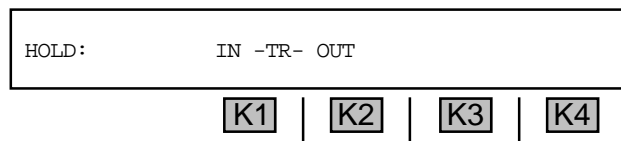
To control one or both **hold coils**:

1. Set up a 4-wire normal loop or 4-wire E&M under the Trunk Type function key, **OR** set up a dry circuit in **OPTION MENU #: 95 DRY CIRCUIT**.
2. Press the **Option Menu** function key.
3. Use the **Up/Down Arrow** keys to scroll through the option menus, **OR** select **97** using the **numeric keypad** and press the **Option Menu** function key. The display reads:

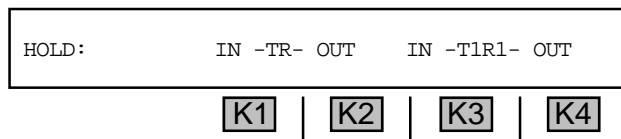


4. Press **ENT** or any softkey (**K1-K4**) to activate your selection.

If you are in **2W** trunk type, the display reads:



If you are in **4W** trunk type, the display reads:



The default settings are **OUT**.

5. Press **K1** or **K3** under **IN** to enable the hold coils. Testing may be performed with either **TR IN** or **OUT, T1R1 IN** or **OUT, both IN** or both **OUT**.
6. Press the **Option Menu** function key to exit this display.

Option Menu #: 97



## SECTION VI

### REMOTE CONTROL OPERATION

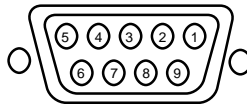
#### 6-1 INTRODUCTION

The **935AT** can be remotely controlled, or may itself control a printer through the **RS-232** serial port located on the **935ATs** rear panel.

#### 6-2 CONNECTIONS

The **935AT** works with most printers and terminals without modification to cables or reconfiguration of pins. The **935AT** serial interface is configured as Data Communication Equipment (DCE) and wants to “see” a Data Terminal Equipment (DTE) connection. If your printer or computer has the capability of being either a DTE or a DCE, make sure that it is set to DTE emulation **before** connecting it to the **935AT**. If the equipment cannot be configured as DTE, it will be necessary to swap pins 2 and 3 (Transmit and Receive Data). This is accomplished by using a special cable known as a null modem cable, or by using a breakout box.

Installation requires a standard female 9-pin miniature “D” type connector (DB-9). (Refer to **Section 3** for the location of the serial port on the rear panel.) The pinouts for the **935AT** connector are shown in **Figure 6-1**.



PIN	TO DTE	TO DCE	NAME	FUNCTION
1	←		DCD	DATA CARRIER DETECT
2	←		RD	RECEIVED DATA
3	←		SD	TRANSMITTED DATA
4		→	DTR	DATA TERMINAL READY
5			SG	SIGNAL GROUND
6		→	DSR	DATA SET READY
7		→	RTS	REQUEST TO SEND
8	←		CTS	CLEAR TO SEND
9	←		RI	RING INDICATOR

**Figure 6-1**  
**RS-232 (DB-9) Connector Pinouts**

**Note:** Older units have a 25 pin RS-232C connector in place of the DB-9 Connector.

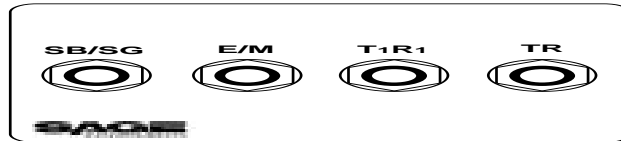
Remote Control Operation

## Section VI Remote Control Operation

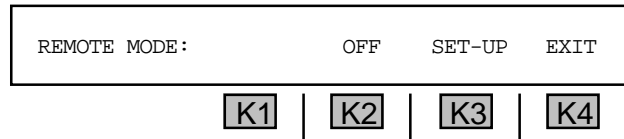
### 6.3 935AT REMOTE CONTROL SETUP

To set up the **935AT** for remote control operation:

1. Press the **Option Menu** function key.
2. Use the **Up/Down Arrow** keys to scroll through the option menus, **OR** select **3** using the **numeric keypad** and press the **Option Menu** function key twice. The display reads:



3. Press **ENT** or any softkey (**K1-K4**) to activate your selection. The display reads:

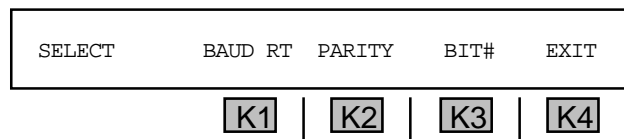


4. Press **K2** to scroll through the different remote modes. The available modes are:

<b>OFF</b>	Manual control (no remote control)
<b>TERMINAL</b>	For use with dumb terminals
<b>MASTER</b>	For future use
<b>SLAVE</b>	For future use
<b>ATR</b>	For future use
<b>COMPUTER</b>	For use under computer control
<b>PRINTER</b>	Used to drive a printer connected to the RS-232 serial port.

The above modes are explained in detail in **Section 6, Remote Control Operation**

5. Press **K1** to put the **935AT** into **STANDBY MODE**. The messages **REMOTE MODE** and **STANDBY MODE** will alternately flash on the display until **K1** is pressed again, releasing **STANDBY MODE**. Use **STANDBY MODE** to operate the **935AT** manually without losing remote access capability.
6. Press **K3** under **SET-UP**. The display reads:

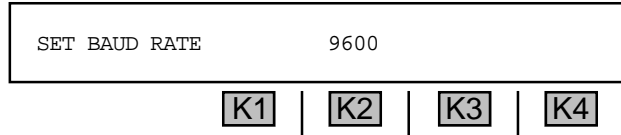


### 6-3.1 Baud Rate

**Baud rate** is the number of bits of data transmitted per second in data transmissions.

To change the **baud rate**:

1. Press **K1** from the **SELECT** display. The new display reads:



2. Use the **numeric keypad** to enter a new baud rate.

- A valid **baud rate** is between 300 and 38400. The default value is 38400 baud.

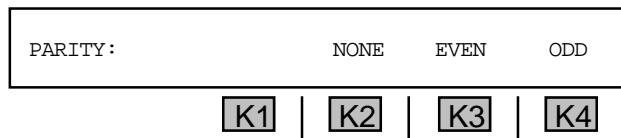
3. Press **ENT** or any softkey (**K1-K4**) to exit this display. You will be returned to the **SELECT** display.

### 6-3.2 Parity

**Parity** is a method of minimizing errors in data transmissions by adding an extra binary signal to each character to make the total number of 1s or 0s either odd or even for each character.

To change the **parity**:

1. Press **K2**. The display reads:



2. Press **K2** under **OFF** for no parity, **K3** for **EVEN** parity **OR** press **K4** for **ODD** parity. The default parity is **EVEN**. You will be returned to the **SELECT** display.

### 6-3.3 Bit Number

The **bit number** is the number of bits that make up a character. 7 bits are used to produce standard ASCII characters.

**Stop bits** are the bit or bits following character code in start stop transmissions.

## Section VI Remote Control Operation

---

To change the **data format**:

1. Press **K3** under **BIT#** from the **SELECT** display. The new display reads:

BITS PER CHARACTER:	7	8	
<b>K1</b>	<b>K2</b>	<b>K3</b>	<b>K4</b>

2. Press **K2** to select **7** bits **OR** **K4** to select **8** bits. The default format is **7** bits per character. Some printers and terminals treat characters with bit **8** used as graphics characters. The display reads:

STOP BITS:	1	1-1/2	2
<b>K1</b>	<b>K2</b>	<b>K3</b>	<b>K4</b>

3. Press **K2** to select **1** stop bit, **K3** to select **1-1/2** stop bitS, **OR** press **K4** to select **2** stop bits. The default stop bit value is **1**. You will be returned to the main display.

## 6-4 PRINTER MODE

---

### 6-4.1 Supported Printer Configurations

---

The **935AT** will work with most printers provided that the printer:

- has an asynchronous RS-232C serial input port
- prints both upper and lower case
- is ASCII compatible
- has a carriage width of at least 50 characters (preferably 80 characters)
- accepts input at 9600 baud
- has at least a 2K buffer
- accepts continuous feed paper.

Sage Instruments currently recommends the Okidata 182 with Super Speed Serial Interface. You may obtain this printer from Sage Instruments by purchasing accessory number *9400-0001-01, 80 Column Printer with Cable*.

Use care with printers that do not have buffers. These printers must be run at a speed at, or below their print speeds multiplied by a factor of 10. That is, an unbuffered printer with a print speed of 30 cps must be run at or below 300 baud, and an unbuffered 120 cps printer would have to be run at or below 1200 baud. If your printer cannot keep up with the **935AT**, switch to a lower baud rate or use one of the printer flow control hand shakes described in **Section 6-4.4** of this manual. Hard copy terminals, such as Teletypes and DECwriters, may also be used as printers, but their low speed tends to degrade **935AT** performance.

While the 935AT can be connected to most serial printers without modification or special cables, printers vary widely in terms of interface requirements. Some may require special cables or an adaptor. Refer to Figure 7-2 for the pinouts of the 935AT serial interface.

### 6-4.2 Printer Applications

ERRORS, RECEIVED DIGITS, DIGIT ANALYSIS and WINK TIMING may be printed. The results of ROTL/Responder tests, frequency sweep and envelope delay measurements will be printed out automatically as they occur if the 935AT is in PRINTER remote mode. The 935AT will also automatically print out every 4 hours or whenever its buffer is full when it is in OPTION MENU #: 8 SUPERVISION MONITOR.

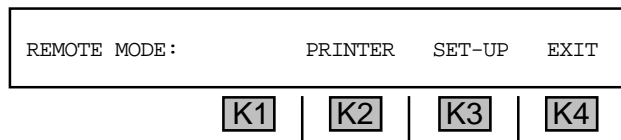
If ERROR reporting is selected, all detected PCM errors will be time stamped and printed out as they occur. If RECEIVED DIGITS reporting is selected, received calls will be printed out whenever a Digit Receiver sequence is completed, or whenever the originating end abandons the call (goes on-hook) in mid-sequence. The number of calls, frequency of inter-LATA vs. intra-LATA calls, the number of incomplete ANI sequences and abandoned calls can all be determined from the 935AT's reports. All reports include a time and date stamp. If DIGIT ANALYSIS has also been selected, the frequency and amplitude of each MF or DTMF tone is displayed together with the Interdigit time, as well as any spurious tones. Dial Pulse digits are analyzed in terms of % Break, Pulses per second and Interdigit time.

WINK TIMING information will be printed out whenever a record sequence is complete, a call is abandoned, or a wink fails. The 935AT times supervision events such as winks when it sends digits or when it receives digits in MONITOR mode. When the 935AT acts as a terminating digit receiver, it provides the winks rather than timing them. WINK TIMING printouts can show the time between line seizure and the first wink, the length of all winks, the time between the end of a digit sequence and a wink, and the time between call completion and answer supervision.

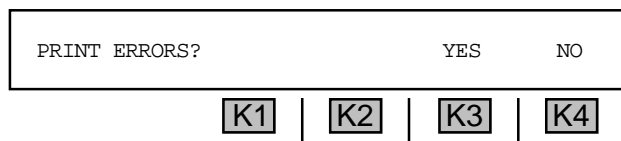
### 6-4.3 Setting Printer Mode Parameters

To set the printing parameters:

1. Follow the remote control setup procedure described in Section 6-3 EXCEPT select PRINTER mode instead of OFF. The display reads:



2. Press K4 under EXIT after completing the setup. The 935AT will advance to a series of questions regarding printing parameters.



## Section VI Remote Control Operation

---

3. Press **K3** under **YES** to send **PCM** errors to the printer **OR** press **K4** under **NO** to omit them. The display reads:

PRINT RECEIVED RECORDS?	YES	NO	
<b>K1</b>	<b>K2</b>	<b>K3</b>	<b>K4</b>

4. Press **K3** under **YES** to send calls captured by the digit receive to the printer, **OR** press **K4** under **NO** to omit them. Selecting **YES** displays the following display. Selecting **NO** skips it:

PRINT DIGIT ANALYSIS?	YES	NO	
<b>K1</b>	<b>K2</b>	<b>K3</b>	<b>K4</b>

5. Press **K3** under **YES** to send the analysis of the received digits to the printer **OR** press **K4** under **NO** to omit them. The display reads:

PRINT WINK TIMING?	YES	NO	
<b>K1</b>	<b>K2</b>	<b>K3</b>	<b>K4</b>

6. Press **K3** to send the wink timing measurements, otherwise press **K4** under **NO** to omit them. The **935AT** will exit the **Option Menu**. The printer will begin to print whenever one of the conditions occurs, or whenever the **ENT** key is pressed.
7. Press the **ENT** key to test your connection. If the output is garbled, adjust the baud rate, parity, or number of bits.

Taking the printer off-line instead of turning off the power may not have the desired effect. The printer buffer may fill up with unwanted material which will be printed out when the printer is placed back on-line.

You will be returned to the **PRINT** display.

### 6-4.4 Printing Test Results

---

Test results are printed from within the option menu functions. The option menu functions that support printing are:

- Option Menu #: 44 T1 Error History
- Option Menu #: 46 DS-1 Bit Error rate
- Option Menu #: 55 DS-0 Fractional T1-BERT
- Option Menu #: 56 DS-0 Bit Error Rate
- Option Menu #: 58 DDS Bit Error Rate



To **print** test results when in printer mode:

1. Set the **935AT** to **PRINTER** mode in **OPTION MENU #: 3 REMOTE CONTROL**.
2. Enter the option menu function in which you will be testing.
3. Go to the **T1 HISTORY** display in the desired **option menu** function. The display reads:

T1 HISTORY:	VIEW	PRINT	EXIT
K1	K2	K3	K4

4. Press **K3** under **PRINT** to send the results to date to a printer or terminal. The display reads:

PRINT:	RANGE	TOTAL	ALL	EXIT
K1	K2	K3	K4	

5. Press **K2** under **TOTAL** to send the accumulated total of errors in each block, press **K3** under **ALL** to send every test in every block, **OR** press **K1** under **RANGE** to specify the number of blocks to print. If you are in **PRINTER** mode, the display reads:

PRINT BLOCK:	1 TO: XX	PRINT	EXIT
K1	K2	K3	K4

If you have not set the **935AT** to **PRINTER**, **COMPUTER** or **TERMINAL** mode (via **OPTION MENU #: 3 REMOTE CONTROL**) you will see a brief message: **NOT IN PRINTER MODE!** The display then reads:

SET PRINTER?	YES	NO	
K1	K2	K3	K4

Press **K2** under **YES** to advance to the **REMOTE MODE** display. This lets you set the parameters for your printer. (Refer to **Section 6-4.1 Setting Printer Mode Parameters**.)

6. Press **K1** to change the beginning block number **OR** **K2** to change the ending block number.
7. Use the **numeric keypad** to enter the valid parameters. The default will show **1 TO <largest block number>**. Up to 96 15-minute blocks may be printed.
8. Press **K3** under **PRINT** when complete.

Remote Control Operation

## Section VI Remote Control Operation

---

9. Press any softkey (K1-K4) or the **Option Menu** function key to abort printing. The display reads:

ABORT PRINTING?	YES	NO	
<b>K1</b>	<b>K2</b>	<b>K3</b>	<b>K4</b>

10. Press **K1** or **K2** under **YES** to abort printing. You will see the message **FINISHING CURRENT BLOCK BEFORE ABORT**. Otherwise, press **K3** or **K4** under **NO**, to resume printing.

If you select nothing, you will be returned to the **PRINT** display.

11. Press **K4** to exit this display **OR** press the **Option Menu** function key to return to the top level display. Before exiting, the display reads:

EXIT WILL CLEAR! OK?	YES	NO	
<b>K1</b>	<b>K2</b>	<b>K3</b>	<b>K4</b>

12. Press **K4** under **NO** to continue within this option **OR** **K3** under **YES** to end (interrupt). You will return to the main display.

### 6-4.5 Printer Handshake

---

**OPTION MENU #: 89 PRINTER HAND SHAKE** allows you to select a form of flow control when the **935AT** sends data to the printer. This allows the printer to tell the **935AT** to stop sending when the printer's buffer is full or the printer is off-line. The factory default setting for the **935AT** is hand shake **OFF** because it is not usually necessary. (Refer to **Section 5-89** for information on printer hand shake setup.)

If your printer misses characters sent by the **935AT**, especially during long printouts such as digit analysis or **T1 BERT** history, select a lower baud rate or use **OPTION MENU #: 89 PRINTER HAND SHAKE** to select a form of flow control.

### 6-4.6 Print Formats

---

This section provides report format details and examples of **935AT** test result printouts.

#### PCM Error Reports

Description: The label **PCM1:** followed by one blank and the error detected on **PCM1** (if any). The label **PCM2:** followed by one blank and the error detected on **PCM2** (if any). An error report is a 40 character string terminated by a line feed and carriage return.

The error report will have the following form:

```

PCM1: NO PCM!           PCM2: NO PCM!
FRAME LOSS              FRAME LOSS
FRAME ERROR             FRAME ERROR
SLIP                    SLIP
BIPOLAR VIO            BIPOLAR VIO
REMOTE ALARM           REMOTE ALARM
BLUE ALARM (ESF)       BLUE ALARM (ESF)
CRC ERROR (ESF)        CRC ERROR (ESF)
>15 ZEROS              >15 ZEROS

```

**Received Record Reports**

A report may consist of up to four received records. Each record is a string of 40 characters terminated by a line and feed carriage return. The final record is followed by an additional carriage return and line feed.

Each record takes the form:

```

0123456789#*ABCD REC#N HOLD DTMF

```

Description: There is a 17 character record field, followed by the label "REC#", the record number (1-4), three blanks, the word "HOLD", three blanks, and the label "MF", "DTMF" or "DP". Dial Pulse records can be digits from 0 to 9. DTMF records can be all digits from 0 to 9 plus the characters "A", "B", "C", "D", "\*", and "#". MF records may additionally include the characters "KP", "ST", "STP", "ST2P", and "ST3P". There are no spaces between characters, and records containing less than 17 characters are preceded by blanks.

**Wink Timing Reports**

Wink timing reports will include all completed or interrupted supervision events from the last record sequence received. Each supervision event is sent as three strings. Each string is terminated by a line feed and carriage return. The first string takes the form: **EVENT #N**.

The string is six characters in length and all supervision events (winks, off-hooks, and delays) are preceded by this string. The second string takes the form:

```

W 01 W 02 03 W H NNNN MSEC GUARD (any sequence)
>16,000 MSEC
>60,000 MSEC

```

The record sequence is printed first and may be up to 17 characters long (shorter sequences are preceded by blanks). The length of the Guard period in milliseconds, or a time-out indicator, followed by the word "GUARD" is printed out next. This string is 40 characters long.

Remote Control  
Operation

## Section VI Remote Control Operation

---

The third string takes the form:

```
W 01 W 02 03 W H NNNN MSEC WINK (any sequence)
      >200                MSEC
OFF-HOOK                FAILED DELAY
```

The record sequence is printed first, and may be up to 17 characters long (shorter sequences will be preceded by blanks). Next, the length of the event in milliseconds, or a time-out or failure indicator, followed by an event type label is printed out. This string is also 40 characters long. The final supervision event in the report is followed by an additional line feed and carriage return.

### 6-5 TERMINAL MODE

---

The **935AT** supports **Televideo** terminals (the Televideo 910, 910+, 912, and 925), terminals that emulate **Televideo** (ADM, WYSE, and Hazeltine), and **VT-100** type terminals.

Terminal mode should be used when writing or debugging programs intended for use in the Computer mode. Terminal mode is fully interactive and comes with on-screen **HELP**. Terminal emulation programs such as **CROSSTALK**<sup>®</sup> and **PROCOMM**<sup>®</sup> allow a PC to operate the **935AT** in terminal mode. Sage Instruments' **STARMAC**<sup>®</sup> Macro language program also support the **935ATs** terminal mode. Contact Sage Instruments for more information on **STARMAC**.

The **935AT** currently does not support Teletypes or other "hard copy only" terminals such as DECwriters, except in **PRINTER** remote mode (refer to **Section 6-2** for details).

#### 6-5.1 Setting Terminal Mode Parameters

---

To set the terminal mode parameters:

1. Complete the setup procedure outlined in **Section 6-3 EXCEPT** select **TERMINAL** mode rather than **OFF**.

The display reads:

```
REMOTE MODE:          TERMINAL  SET-UP  EXIT
      [K1] | [K2] | [K3] | [K4]
```

2. Press **K4** under **EXIT** after completing the setup procedure. The display reads:

```
TERMINAL TYPE:          TVI-920          VT-100
      [K1] | [K2] | [K3] | [K4]
```

3. Press **K2** to use Televideo 920 (or similar terminal), **OR** press **K4** for a **DEC VT-100** terminal. You will return to the previous display.

The terminal's display will be somewhat like that shown in **Figure 6-3** below.

---

```
NORMAL LOOP TERM CONTACT 2W 900 o t (Current Trunk Type)
  [ J ] [ K ] [ L ] [ ; ] ORIG TERM
```

---

```
A) TRUNK TYPE
B) DIAL/RING
C) RETURN LOSS
D) SEND TONE
E) MEAS TONE
F) MEAS NOISE
G) OPTIONS
```

```
UPPERCASE O)   GO OFF HOOK      ?) HELP      CR) ENTER  SP)  CLEAR
Lowercase o)   GO ON HOOK S) STO      R) RCL      N)  RCL NEXT
```

When sending digits:  
To send: 0 1 2 3 4 5 6 7 8 9 - KP ST STP ST2P ST3P +/-  
Type: 0 1 2 3 4 5 6 7 8 9 - \* # a b c d

---

**Figure 6-3**  
**Computer Display in Terminal Mode**

### **6-5.2 Terminal Keyboard Equivalents to the 935AT Keypad**

Each key on the **935AT**'s front panel is mapped to a key on your terminal keyboard. All commands given to the **935AT** manually can also be done remotely. The terminal keyboard equivalents are the same as those listed in **Section 6-6.1 Computer Keyboard Equivalents to the 935AT Keypad**.

### **6-5.3 Troubleshooting**

<b>Symptom:</b>	Terminal CRT remains blank.
<b>Probable Cause:</b>	Faulty or improper RS-232 cable connection.
<b>Solution:</b>	Check cables, power to the terminal and RS-232 pinouts.
<b>Symptom:</b>	Terminal prints "gibberish".
<b>Probable Cause:</b>	Incorrect data format.
<b>Solution:</b>	Turn terminal off. Set <b>935AT</b> Remote Mode to <b>OFF</b> . Check <b>935AT</b> baud rate, parity, character size, and stop bits. Check terminal DIP switches to be sure of their data format. Turn terminal on. Set the <b>935AT</b> remote mode to <b>TERMINAL</b> and press <b>K4</b> to <b>EXIT</b> . Select a terminal type.

Remote Control  
Operation

## Section VI Remote Control Operation

---

<b>Symptom:</b>	The <b>935AT</b> does not respond to terminal commands.
<b>Probable Cause:</b>	Bad mechanical connection or <b>CAPS LOCK</b> not down.
<b>Solution:</b>	For mechanical condition, check the cables and connectors (broken pins), power, and <b>RS-232</b> pinouts. Be sure that uppercase commands are being sent when intended. The <b>935AT</b> uses only a few lowercase commands so the <b>CAPS LOCK</b> key on the terminal should generally be down.
<b>Symptom:</b>	<b>935AT</b> responds to some commands but not others.
<b>Probable Cause:</b>	Broken lead in <b>RS-232</b> cable or wrong data format.
<b>Solution:</b>	For data format, refer back to the "gibberish" symptom. Be sure parity and number of bits are correct. Test the <b>RS-232</b> cable with an ohmmeter or by replacing with another cable.

### 6-6 COMPUTER MODE

---

The **935AT** can be operated under the control of any computer capable of sending and receiving serial ASCII characters over an **RS-232** link. Each key on the **935AT**'s front panel is mapped to an ASCII character on the computer keyboard. Refer to **Table 6-2** for ASCII-to-Front Panel conversions as well as HEX and Decimal equivalents.

#### 6-6.1 Setting Computer Mode Parameters

---

To set the **computer mode parameters**:

1. Complete the setup procedure outlined in **Section 6-3 EXCEPT** select either **COMPUTER** or **TERMINAL** mode.
2. Complete the setup procedure in **OPTION MENU #: 34 SELECT REPORTS**. (Refer to **Section 5-34 OPTION MENU #: 34 SELECT REPORTS** for a complete description.)

## 6-6.2 Computer Keyboard Equivalents to the 935AT Keypad

Each key on the **935AT**'s front panel is mapped to a key on your computer keyboard. All commands given to the **935AT** manually can also be done remotely. All legal commands are listed on the screen and all measurements are returned immediately and updated continuously.

<u>ASCII CHARACTER</u>	<u>935AT FUNCTION</u>	<u>HEX</u>	<u>DECIMAL</u>	
[0]	0	30	48	
[1]	1	31	49	
[2]	2	32	50	
[3]	3	33	51	
[4]	4	34	52	
[5]	5	35	53	
[6]	6	36	54	
[7]	7	37	55	
[8]	8	38	56	
[9]	9	39	57	
[*]	*	2A	42	
[#]	#	23	35	
[a]	A	61	97	
[b]	B	62	98	
[c]	C	63	99	
[d]	D	64	100	
[*]	KP	2A	42	
[#]	ST	23	35	
[a]	STP	61	97	
[b]	ST2P	62	98	
[c]	ST3P	63	99	
[A]	Trunk Type	41	65	
[B]	Dial/Ring	42	66	
[C]	Return Loss	43	67	
[D]	Send Tone	44	68	
[E]	Measure Tone	45	69	
[F]	Measure Noise	46	70	
[G]	Option Menu	47	71	
[ENTER]	Enter (ENT)	0D	13	
[SPACE]	Clear (CLR)	20	32	
[?]	Help (HELP)	3F	63	
[S]	Store (STO)	53	83	
[R]	Recall (RCL)	52	82	
[N]	Recall Next (RCL NXT)	4E	78	
[d]	Change Sign (+/-)	64	100	
[–]	Pause (Left Arrow)	2D	45	
[O]	Go Off Hook	4F	79	
[o]	Go On Hook	6F	111	
[J]	K1	4A	74	
[K]	K2	4B	75	
[L]	K3	4C	76	
[;]	K4	3B	59	
[^H]	(~ Cursor)	Left Arrow	08	8
[^L]	(Æ Cursor)	Right Arrow	0C	12
[^K]	(≠ Cursor)	Up Arrow	0B	11
[^J]	(∅ Cursor)	Down Arrow	0A	10

Remote Control  
Operation

**Table 6-1**  
**ASCII to Front Panel Key Conversion**

**Section VI Remote Control Operation**

**Note:** When monitoring the **935AT**'s supervision lamps, a lowercase [**o**] and [**t**] in the display indicate that both the originating and terminating ends are **On Hook**. An uppercase [**O**] and [**T**] indicates an **Off Hook** condition at the originating or terminating end. A [-] in either location means no indication and generally signifies an incomplete or faulty circuit.

**Remote Control  
Operation**

<u>ASCII CHARACTER</u>	<u>935AT FUNCTION</u>	<u>HEX</u>	<u>DECIMAL</u>
[H]	Causes the <b>935AT</b> to send a copy of its terminal HELP screen (see <b>Figure 7-3</b> ) to the remote computer or terminal.	48	72
[m]	Causes <b>935AT</b> to send Hang-Up string to a Hayes compatible MODEM.	6D	109
[s]	Places <b>935AT</b> in <b>STANDBY MODE</b> .	73	115
[W]	Causes the <b>935AT</b> to report all pending PCM errors, received records, wink timing information or 105 test results to the host computer. Information is "pending" when an ALERT has been sent but no REPORT has been requested.	57	87
[X]	Interrupts the <b>935AT</b> and causes it to send an immediate copy of its current display line to the host computer. This command is not buffered and executed in turn. It is executed at once.	58	88
[Y]	Causes the <b>935AT</b> to send a copy of its current display line to the host computer. This command is buffered and executes after all previous commands have been completed.	59	89
[Z]	Causes the <b>935AT</b> to send a copy of its current display line after it determines that a valid measurement has been made. A series of consecutive [ <b>Z</b> ] commands will cause the <b>935AT</b> to send consecutive measurements to the host computer.	5A	90

**NOTES:** The [**X**], [**Y**], and [**Z**] commands all cause the **935AT** to send a copy of its display line to the host computer.

The [**X**] command executes immediately and can be used to find the current status of the **935AT**. This allows "spot checking" progress through a command sequence at any time.

The [**Y**] command tells the **935AT** to send a copy of its display line when it reaches a certain point in the command sequence. This can be used to obtain a measurement or start a timer in the host.

The [**Z**] command is like the [**Y**] command, except that successive [**X**] commands will each be delayed by one measurement period.

**Table 6-2  
Special ASCII Characters for Remote Control**



### 6-6.3 Input to the 935AT

Input to the **935AT** is in the form of “command strings.” These are strings of ASCII characters that the **935AT** recognizes as commands. A command string may be from 1 to 40 characters in length. The **935AT** has a 40-character input buffer. **Tables 6-1** and **6-2** contain summaries of these commands and **Section 7-3.2** describes them.

The **935AT** will echo each character back to the computer as it is received and placed in the buffer. **DO NOT SEND THE NEXT CHARACTER UNTIL THE ECHO HAS BEEN RECEIVED.** This is the **935AT** input protocol (actually a hand shake). The **935AT** executes the commands in the order they are received, with the exception of the **[X]** command which executes immediately. When all received commands have been executed and the input buffer is empty, the **935AT** will signal the host computer with a “>” prompt.

The **935AT** will echo and ignore any characters it does not recognize as commands in this mode until released by pressing **[L]** under **HOLD**.

### 6-6.4 Output from the 935AT

Output from the **935AT** consists of the following:

<b>ECHOES</b>	The <b>935AT</b> echoes all received characters to the host computer.
<b>PROMPTS</b>	When the <b>935AT</b> has executed all received commands and its command buffer is empty, it sends a prompt consisting of a line feed, carriage return, and a <b>[&gt;]</b> character. The ASCII sequence in Hexadecimal code is 0A 0D 3E. Some data strings include the <b>[&gt;]</b> character, but the 0D 3E sequence is unique.
<b>ALERTS</b>	Under certain circumstances, the <b>935AT</b> will send a “bell” character (ASCII 07) to alert the host computer that it has something to report. Any programs the user writes should screen all <b>935AT</b> output carefully for this character. If the <b>OPTION MENU #: 15 BEEP ON ERROR</b> is set to <b>OFF</b> , the bell character will not be sent.
<b>DATA</b>	When the <b>935AT</b> executes an <b>[X]</b> , <b>[Y]</b> , or <b>[Z]</b> command, it sends a copy of its current display line and supervision status. This is a 50-character line terminated by a line feed and carriage return. <b>Section 6-6.5</b> contains details of display line formats.
<b>REPORTS</b>	If the <b>935AT</b> has sent the host computer an <b>ALERT</b> , it will respond to the <b>[W]</b> command with a report concerning what caused the <b>ALERT</b> . This could be a PCM error, a completed Receive Record sequence, Wink Timing information, 105 test results, or some combination of the four. <b>Section 6-4.5</b> contains further details of Report Formats. When used as a near-end responder ( <b>OPTION MENU #: 26 ROTL RESPONDER</b> ), the <b>935AT</b> will send an alert (bell) at the completion of each test.

## Section VI Remote Control Operation

### 6-6.5 Display Line Formats

A display line is always 50 characters long, terminated by a carriage return and line feed. The first 40 characters of a display line mirror the display on the front panel of the **935AT**. The next 4 characters are ASCII blanks. The next character shows originating supervision. The next 4 characters are ASCII blanks. The last character shows terminating end supervision.

In the following examples of typical PC screen displays, numbers are denoted by a single **[N]** for each possible digit. Each **[N]** may stand for any number. Signed numbers are shown preceded by a **[+]** or **[-]** character.

Leading zeros are printed as blanks and trailing zeros are printed as zeros. The digit to the left of the decimal point will always be printed, including leading zeros. The sign of the number will always be printed to the left of the first non-blank digit. Uppercase **[O]** or **[T]** indicates an off-hook condition; lowercase **[o]** or **[t]** represent an on-hook condition. These symbols are not seen on the **935AT** display.

Typical example displays of the computer's CRT are below:

#### In Measure Tone:

NNNN Hz	+NN.N dBm0	AVERAGE	PCM1	O	T
----	OVER dBm	RMS	PCM2	o	t
----	dB		T1R1	-	-
----	dB		TR	-	-

**Description** Seven leading blanks, followed by the frequency in Hz or four dashes, the label **Hz**, a signed level or the over or under indication (**OVER** or **----**), the relative zero label, the **AVERAGE** or **RMS** label, and the signal source label.

#### In Measure Noise:

+NNN	dBrn0 C-NOTCH	PCM1	CHANNEL	O	T
	dBrn 3K FLT	PCM2	N-TO-G	o	t
	dB C-MSG	T1R1	BAL	-	-
	dB S/N	TR			

**Description** Three leading blanks, followed by a signed level measurement, the relative zero label, the filter type, the signal source label, and the type of measurement.

#### In 4W Return Loss:

+NNNdB	SRL LO	NNNN Hz	+NN THL	4W 1200	O	T
	SRL HI			4W 900	o	t
	ERL			4W 600	-	-
	OSC			PCM1		
				PCM2		

**Description** Two leading blanks, followed by a signed level measurement and the label **dB**, the signal type, the frequency of the echo suppress tone or the oscillator tone, and the label **Hz**, a signed transhybrid loss level and the label **THL**, and a Trunk Type label.

**In 2W, Normal Return Loss:**

+NNNdB	SRL LO	NNNNHz	2W 1200	O	T
	SRL HI		2W 900	o	t
	ERL		2W 600	-	-
	OSC		2W 150		

**Description** Two leading blanks, followed by a signed level measurement and the label **dB**, the signal type, the frequency of the echo suppress tone or oscillator tone, and the label **Hz**, 10 blanks, and a Trunk Type label.

## 6-7 PROGRAMMERS NOTES

### 6-7.1 Initializing the 935AT

Send the command string **[AAA]** when you first access the **935AT** remotely. This ensures that you have exited from any tests or submenus the **935AT** may have been left in. You may use any of the function key commands (**[A]**, **[B]**, **[C]**, **[D]**, **[E]**, **[F]** or **[G]**), but three repetitions is the minimum necessary to bring the **935AT** to a known state before testing. By sending **[AAA]** you take the **935AT** to the **Trunk Type** menu, no matter where it was previously. Sending **[GGG]** would take the **935AT** to the **Option Menu** instead.

After this initial string has been sent, send a trunk type initialization string to ensure that the **935AT** is properly terminated or bridged, looking at the correct signaling leads, etc. Use the **HELP** menu under the **Trunk Type** function key to accomplish this. Two examples are:

LOOP	TERM	CONTACT	2W 900: [A?J; ;LKK]
E&M TYPE II	TERM	SEND-E	4W 600: [A?L2JK;K;]

Append a lowercase **[o]** to your initialization string to ensure that the **935AT** is on hook.

To ensure that the **935AT** is in quiet termination (sending no tone), send a send tone initialization string such as **[?;1004J160J]**. This sequence sets the frequency to 1004 Hz, the level to -16.0 dBm, and the output to **OFF**. The numeric input for frequency and level were terminated by the **[J]** character. Numeric input may be terminated by a carriage return or any K(**[J]**, **[K]**, **[L]**, **[;]**). The **[J]** character has been used in all the examples contained in this document.

You may now use the **935AT** to send or receive calls, send and measure tones and other VF signals, and perform automated tests to remote test lines and responders. **Section 6-8 HELP MENU** will get you started. There are separate sections on placing multistage calls using the digit receiver/analyzer, and placing calls to remote testlines and responders.

For the convenience of programmers, the **935AT** may be commanded remotely to dump its buffers and restore itself to the factory defaults. **OPTION MENU #: 92 SOFTWARE COLD-BOOT** is used for this purpose.

## Section VI Remote Control Operation

---

To remotely cold-boot the **935AT**, perform the following sequence: **GGG92|K**

This command does not affect the **RS-232** remote port settings nor does it affect the time/date settings.

A hardware cold-boot (recycling power while holding down a function key) will restore the RS-232 port settings to their factory default values.

### 6-8 HELP MENU

---

Pressing the **HELP** key on the **935AT** brings up a series of menus for the user. The menu presented will depend on the function the **935AT** is executing. Transmitting the ASCII **[?]** character remotely has the same effect as pressing the **HELP** key on the **935AT** front panel.

Many of the **935AT**'s features are controlled using softkeys (the four unlabeled keys directly beneath the display). The current setting is usually displayed above the softkey. If the **935AT** displayed your parameter, continue to the next display, otherwise press the softkey until the **935AT** displayed the setting you wanted.

Using the **HELP** menus allows the computer to avoid this procedure. Once you have used a **HELP** menu to put the **935AT** in a known state, it may be more efficient to use the softkeys in the usual way. You would always use the **HELP** menu when your program begins: this provides a simple and foolproof initialization. After using a **HELP** menu once to put the **935AT** in a known state, you may continue to use the **HELP** menus throughout your program.

The following section gives a brief overview of the **HELP** menus and includes some sample command strings.

Remote Control  
Operation

#### Trunk Type function key (Analog circuits)

Trunk Type	Help	Type/Sense	Direction	Bridge/Term	Ohms 2W/4W
Trunk Type	[A] =	Trunk Type			
Help	[?] =	Help			
Type	[J] =	Loop	[K] = Gnd-Start	[L] = {1-5}	[J] = E&M Type I-5
Sense*	[K] =	Normal	[:] = Reverse		
Direction	[K] =	Battery	[:] = Contact	[K] = SEND-E	[:] = SEND-M
Bridge/Term	[K] =	Bridge	[:] = Terminate		
Ohms	[J] =	150Ω	[K] = 600Ω	[L] = 900Ω	[:] = 1200Ω
2W/4W	[K] =	2 Wire	[:] = 4 Wire		

\* (Loop and Gnd-Start only)

**Examples:**

E&M Type I	TERM	SEND-E	4W 600	[A?L1JK;K;]
E&M Type II	TERM	SEND-M	2W 900	[A?L2J; ;LK]
LOOP NORMAL	TERM	CONTACT	2W 900	[A?JK; ;LK]
Toggle Bridge/Term		[K]		
Toggle Direction	[L]			

**Dial/Ring function key**

**Dial/Ring Help Pulsing Digits**

**Dial/Ring B = Dial/Ring**  
**Help ? = Help**  
**Pulsing K = Dial Pulse; L = MF; = DTMF**

**Digits Up to 17 digits**

All pulsing types: 0-9, [-] for 1 sec. pause  
 DTMF: a,b,c,d,\*,#  
 MF: \*=KP, #=ST, a=STP, b=ST2P, c=ST3P

If you are already off-hook, the digits will be sent immediately. If you are on-hook, the digits will be stored in **Dial/Ring**. Go off-hook and send ASCII [K] to send stored digits.

Sending an ASCII blank (spacebar) [ ] clears any existing digits. Using the **HELP** key also clears any previous digits.

**Examples:**

Go to **Dial/Ring**. Go off-hook. Select DTMF. Dial (408) 761-1000:  
 [BO? ;4087611000]

Go to **Dial/Ring**. Go on-hook. Select MF. Store KP007ST to be dialed later:  
 [Bo?L\*007#]

Go to **Dial/Ring**. Go off-hook. Select Dial Pulse. Pause 1 second and dial 9:  
 [BO?K-9]

Go to **Dial/Ring**. Go off-hook and send the most recently entered digit string:  
 [BOK]

Go to **Dial/Ring**, clear any old digits, and dial 411 in the current pulse mode:  
 [B 411]

## Section VI Remote Control Operation

### Return Loss function key

4W:

Return Loss Help Band Frequency Acknowledge Set THL

Return Loss	[C] = Return Loss
Help	[?] = Help
Band	[J] = SRL-LO [K] = SRL-HI [L] = ERL [;] = OSC (sine wave)
Frequency	[nnnnJ] = freq of nnnnHz for echo suppress tone and/or sine wave return loss
Acknowledge	[J],[K],[L] or [;] =acknowledges message
Set THL	[L] = Current measurement is THL [;nnJ] = THL is -nn dB

2W:

Return Loss Help Mode [Band Frequency] or [Termination]

Return Loss	[C] = Return Loss
Help	[?] = Help
Mode	[K] = Return Loss [;] = TR Termination

Return Loss:

Band	[J] = SRL-LO [K] = SRL-HI [L] = ERL [;] = OSC (sine wave)
Frequency	[nnnnJ] = freq. of nnnn Hz for echo suppress tone and/or sinewave

TR Termination:

Termination: [J] = AC Short [K] =  $600\Omega+2.14\mu\text{F}$  [L] =  $900\Omega+2.14\mu\text{F}$  [;] = AC Open

*Examples:*

4W:

Go to Return Loss. Select ERL, 2225 Hz Echo Suppress, no THL compensation: [C?L2225JJ0J]

Go to Return Loss. Select SRL-LO, 2225 Hz Echo Suppress, measure THL: [C?J2225JJK]

2W:

Go to Return Loss. Select SRL-LO, 2225 Hz Echo Suppress tone: [C?KJ2225J]

Go to Return Loss. Select  $900\Omega$  with  $2.14\mu\text{F}$  quiet termination: [C?;L]

All types:

Send echo suppress tone: [K]

### Send Tone function key

Send Tone Help Output Frequency Level

Send Tone	[D =] Send Tone
Help	[? =] Help

**Output** [K =] ON [;] = OFF  
**Frequency** [nnnnJ] = frequency of nnnn Hz  
**Level** [nnnJ] = level of -nn.n dBm (for level of +nn.n dBm, send [nnndJ])

**Examples:**

Send 1004 Hz at 0.0 dBm: [D?K1004J0J]

Send 1004 Hz at -16.0 dBm: [D?K1004J160J]

Send 2804 Hz at -13.0 dBm: [D?K2804J130J]

Send 404 Hz at +3.2 dBm: [D?K0404J32dJ]

Set frequency and level to 1004 Hz at -10.0 dBm, do not send tone: [D?;0104J100J]

Toggle tone on/off: [D;]

Set frequency to 1010 Hz: [DJ1010J]

Set level to -16.0 dBm: [DK160J]

**Measure Tone function key**

**Measure Tone** Help Reference Mode\*

**Measure Tone** [E]= Measure Tone  
**Help** [?]= Help  
**Reference** [K]= Absolute (dBm) [L] = Set 0 (dB relative to current level)  
 [;nnnJ] = dBm0 (dB relative to -nn.n dBm)  
**Mode\*** [K] = Average<sup>1</sup> [;] = RMS<sup>2</sup>

- \* Software Rev. 3.17 and later.
- 1 Use **AVERAGE** to measure sine waves.
- 2 Use **RMS** to measure the level of non-sinewave tones and digital milliwatt.

**Examples:**

Measure in dBm: [E?KK]

Make future measurements in dB relative to -16.0 dBm: [E?;160JK]

Make future measurements in dB relative to current measured level: [E?LK]

## Section VI Remote Control Operation

---

Make **RMS** measurements in dBm: [E?K;]

Toggle **RMS/AVERAGE**: [L]

Measure tone: [E] [Z] (Wait 1 sec. between sending [E] and [Z] or [EZZ]. Disregard first measurement.

If a tone has been selected in **Send Tone** and the output is **ON**, the tone will also be sent in **Measure Tone**. To measure far-to-near tone on a 2-wire circuit, be sure **Send Tone's** output is set to **OFF**.

### Measure Noise function key

#### Measure Noise Help Filter Mode\* Reference

Measure Noise	[F] = Measure Noise
Help	[?] = Help
Filter	[J] = 3 KHz flat      [K] = C-Message      [L] = C-Notch      [;] = Signal/Noise
Mode*†	[K] = Balanced      [;] = Noise/Ground
Reference†	[K] = Absolute (dBrn)      [L] = Set 0 (dB relative to current level)
	[;nnndJ] = dBrn0 (dB relative to nnn dBrn)

\* Not available in PCM. In PCM the **935AT** measures channel noise only.

† Not available when making signal/noise measurement.

#### *Examples:*

Measure balanced noise in dBrnC using the C-Notch filter: [F?LKK]

Measure signal/noise: [F?;]

Measure noise-to-ground relative to 90 dBrn using the 3 KHz flat filter: [F?J;090dJ]

Measure noise: [F] [Z] Wait 1 sec. between sending [F] and [Z] or [FZZ].  
Disregard first measurement

If a tone has been selected in **Send Tone** and the output is **ON**, the tone will also be sent in **Measure Noise**. To measure far-to-near noise on a 2-wire circuit, be sure **Send Tone's** output is set to **OFF**.

## 6-9 BELL CHARACTER

---

The **935AT** can be set to wait for or detect a variety of events. The **935AT** sends the bell character to report these events. Some events are reported only if the user selects them; other events are reported only if the **935AT** is performing a certain function. Select the events to be reported from **OPTION MENU #34: SELECT REPORTS**. The following lists the events and conditions for a bell to be sent.



**EVENT**

**PCM ERROR**--An error on the T1 span such as a slip, bipolar violation, remote alarm, etc., has been detected.

**INCOMING CALL COMPLETE**--The 935AT has received a call.

**WINK TIMING AVAILABLE**--A call has completed or abandoned, and a wink, off-hook, delay dial event, dial tone or credit card "bong" was expected.

**WINK FAILURE**--An expected wink, off-hook, delay dial event, dial tone or "bong" failed to appear or was not recognizable.

**SIGNALING BIT CHANGE**--An A, B, C, or D bit has changed state on one of the 24 PCM Channels.

**RINGING or LINE SEIZURE**--The 935AT detects ringing or seizure and goes off-hook.

**IMPULSE or HIT**--An impulse, gain hit, phase hit or dropout has occurred.

**CALL PROGRESS FAILURE**--The 935AT detects Busy, Reorder, Dead Line or any other call progress failure when it attempts to access a testline.

**TEST DATA AVAILABLE**--A test to a far-end testline has completed, or has a screen full of results available. LOSS has one screen of data (one bell), GAIN SLOPE has three screens of data (one bell each), etc.

**REPORTED WHEN 935AT IN:**

PCM Trunk Type.  
REPORT PCM ERRORS selected.

Option Menu 4: Digit Receiver  
REPORT RECEIVED RECORDS selected.

Option Menu #: 2 Send Digit Sequences.  
Option Menu #: 4 Digit Receiver.  
REPORT WINK TIMING selected.

Option Menu #: 2 Send Digit Sequences.  
Option Menu #: 4 Digit Receiver.

PCM Trunk Type.  
Option Menu 20: 24 Bit Display.

Option Menu #: 32 Dial-Up Testline.  
Option Menu #: 33 Dial-Up Sweep.

Option Menu #: 11 Impulse and Hits.

Calling to a testline from:  
Option Menu #: 2 Send Digit Sequences.  
Option Menu #: 26 ROTL/Responder.  
Option Menu #: 27 ROTL Interrogator.  
Option Menu #: 28 Transponder Test.  
Option Menu #: 29 Call 102 Line.

Calling to a testline from:  
Option Menu #: 2 Send Digit Sequences.  
Option Menu #: 26 ROTL/Responder.  
Option Menu #: 27 ROTL Interrogator.  
Option Menu #: 28 Transponder Test.  
Option Menu #: 29 Call 102 Line.



## SECTION VII

### SPECIFICATIONS

This section contains general information regarding the installation and operation of the Sage Instruments **935AT** Communications Test Set.

The **935AT** specifications are listed in **Section 7-1**. These specifications are the performance standards or limits against which the instrument is tested. Options for the instrument have separate specifications which are provided on supplementary specification sheets or within the sections of this manual describing the specific option.

#### 7-1 DESCRIPTION

---

The **935AT** combines the functions of a Transmission Impairment Measurement Set (TIMS); a Return Loss Measurement Set; Dial Pulse, Touchtone® (DTMF) and Multi-Frequency (MF) Sender and Talk Battery supply into one lightweight package. Hardware and software options allow the user to greatly increase the capabilities of the **935AT**.

#### 7-2 STANDARD FEATURES

---

##### 7-2.1 Level/Frequency

---

###### TRANSMITTER

Frequency Range:	50 Hz to 5.0 kHz (0.131)
Resolution:	1 Hz
Accuracy:	±1.0 Hz
Output Steps:	1 Hz, 10 Hz, 100 Hz, or 1000 Hz steps
Frequency Sweep:	Single or Continuous with selectable bounds, level and step size.
Level Range:	-60 dBm to +12 dBm
Resolution:	0.1 dB
Accuracy:	±0.1 dB @ 1020 Hz (0 to -19 dBm) ±0.2 dB at all other frequencies.
Flatness:	±0.2 dB (200 Hz to 5 kHz referenced to level at 1 kHz)
Distortion:	-70 dB @ 1020 Hz, 0 dBm

###### RECEIVER

Frequency Range:	50 Hz to 5.0 kHz
Resolution:	1 Hz
Accuracy:	±1.0 Hz
Level Range:	-50 dBm to +12 dBm
Resolution:	0.1 dB
Accuracy:	±0.1 dB @ 1020 Hz (0 to -19 dBm), ±0.2 dB @ 200 Hz to 5 kHz
Detector:	RMS or Average

## Section VII Specifications

---

### 7-2.2 Noise Measurements

---

Input: Balanced or Noise-to-Ground

Weighting Filters: C-MSG, C-NOTCH, 3 kHz Flat  
Notch Filter: 1010 Hz (995 Hz to 1025 Hz Notch); >60 dB Notch depth  
Range: 10 dBrn to 100 dBrn (Balanced) 50 dBrn to 130 dBrn (Noise-to-Ground)  
Resolution: 1.0 dB  
Accuracy:  $\pm 0.5$  dB

#### **SIGNAL-TO-NOISE**

Level Range: -50 dBm to +10 dBm  
Noise Range: 10 dBrn to 90 dBrn  
S/N Range: 10 dB to 70 dB  
Accuracy:  $\pm 0.5$  dB  
Resolution: 1.0 dB

### 7-2.3 Return Loss

---

Modes: ERL, SRL-Low, SRL-High or Sinewave (OSCillator mode)  
Transmitted Signal: Meets the specifications of Bell Publication 41009 (page 13, Tables D, E, and F) and IEEE Standard 743-1984

#### **ECHO CANCELLER DISABLE TONE**

Frequency: 2100 Hz,  $\pm 1$  Hz  
Phase Reversals: 450 ms,  $\pm 5$  ms; 180°,  $\pm 5$ °  
Level: -12 dBm0,  $\pm 1$  dB

#### **2-WIRE RETURN LOSS**

Transmitter Level: -10 dBm0  
Receiver Range: 0 dB to 40 dB  
Resolution: 1.0 dB  
Accuracy:  $\pm 0.5$  dB  
Internal Hybrid Impedance: 600 or 900 Ohms  $\pm 0.1\%$  in series with 2.16  $\mu$ F  $\pm 1\%$

#### **4-WIRE RETURN LOSS**

Impedance: 150, 600, 900, or 1200 Ohms  
Transhybrid Loss Compensation: -30 dB to +30 dB  
Transmitter Level: -10 dBm0—in Oscillator mode the level is 0 dBm relative to the TLP  
Receiver Range: -10 dB to 50 dB  
Resolution: 1.0 dB  
Accuracy:  $\pm 0.5$  dB

### 7-2.4 Supervision/Signaling

---

**WINK TIMING**

Resolution: 5 ms  
 Accuracy:  $\pm 5$  ms  
 Wink Fail Event: Fails for wink period >600 ms  
 Off-Hook Fail Event: Fails for Off-Hook period <600 ms

**E/M SUPERVISION**

Types: I, II, III, IV, V  
 Battery: -48 VDC current limited to 200 mA  
 Threshold Voltages:

	<u>E Lead</u>	<u>M Lead</u>
On-hook	< -39 V	> -11 V
Off-hook	> -11 V	< -39V

**LOOP SUPERVISION**

Types: 2- and 4-wire Loop Start, Ground Start, Loop Reverse Battery, and SX supervision.  
 Battery: -48 VDC series limited to 120 mA

**MF AND DTMF SUPERVISION**

Frequency Accuracy:  $\pm 0.1\%$  of ITU-T Standard Frequencies  
 Adjustment Range: Tone Frequencies adjustable in 0.1% steps to  $\pm 10\%$  of standard Bell frequencies for Margining Tests.  
 Level: Automatically adjusted to -7 dBm0 per tone.  
 Level Adjustment Range: Tone level adjustable in 0.1 dB steps from -60.0 dBm to +6.0 dBm  
 Resolution: 0.1 dB  
 Accuracy:  $\pm 0.2$  dB  
 Timing: MF: 70 ms Tone On and Tone Off (KP is 100 ms Tone On)  
 DTMF: 50 ms Tone On and Tone Off  
 Timing Adjustment Range: Tone On and Tone Off times adjustable in 1 ms steps from 13 to 267 ms  
 Resolution: 1 ms  
 Accuracy:  $\pm 1.0$  ms

### 7-2.5 Dial Pulse Sender

---

**PPS**

Range: 2 to 50 PPS (PCM), 2 to 35 PPS (metallic)  
 Resolution: 0.1 PPS  
 Accuracy:  $\pm 1.0\%$  at 10 PPS

**% BREAK**

Range: 5 to 95%  
 Resolution: 0.1%  
 Accuracy:  $\pm 1.0\%$  for 25% to 75% BRK at 10 PPS

**INTERDIGIT TIMING**

Range: 40 to 990 ms  
 Resolution: 10 ms  
 Accuracy:  $\pm 5$  ms

## Section VII Specifications

---

### 7-2.6 MF/DTMF/DP Receiver and Analyzer

---

#### **MF AND DTMF**

Input Level Range:	-25 dBm to 0 dBm
Accuracy:	±0.2 dB
Resolution:	0.1 dB
Input Frequency Range:	±10% of AT&T standard frequencies for MF and DTMF tones
Accuracy:	±0.1%
Resolution:	1 Hz
Input Tone on/off Range:	35 ms. to 250 msecs. Tone on 35 msecs. to 250 msecs. Tone off
Accuracy:	±5 ms
Resolution:	1 ms

#### **DIAL PULSE (DP)**

PPS Range:	5 PPS to 30 PPS
Accuracy:	±2% @ 10 PPS
Resolution:	0.1 PPS
% Break:	10% to 90%
Accuracy:	±2% (25% to 75% break at 10 PPS)
Resolution:	1%
Interdigit Timing Range:	50 ms. to 990 ms
Accuracy:	±5 ms
Resolution:	1 ms

### 7-2.7 SF Supervision

---

SF Oscillator:	2604 Hz ± 1.0 Hz
Send Level:	-36 dBm0 on-hook, -13 dBm0 pulse
Receiver Sensitivity:	-42 dBm0

### 7-2.8 DS-1 PCM Drop/Insert Options

---

Format:	DS-1 AMI or B8ZS Line Code
DS-1 Input Frequency:	1.544 Mbps ±15 kbps
Jitter Tolerance:	Exceeds Bell Pub 43802 Requirements
Channel Numbering	
Sequence:	D1D, D2, D3/D4/D5
Signaling Mode:	NORM (Robbed Bit) or CCIS
Framing Format:	D4 Superframe, Extended Superframe or SLC-96
Selection:	Automatic or manual selection of frame format-D4/SF or ESF
Input Mode:	Terminated: 100 Ohms nominal Bridging: >1000 Ohms
Input Level:	200 mV to 6.0 V. base-to-peak
Input Level Measurement:	200 mV to 6.0 V. ±50 mV base-to-peak or -23 dBdsx to +3 dBdsx ±1 dB
DS-1 Output:	1.544 Mbps ±40 bps (Stratum 4) in INTERNAL Clock mode. Output rate equal to input rate in LOOP-TIMED mode
Frequency Skew:	Output frequency can be shifted by 100 bps in INTERNAL Clock mode to verify far-end loop-timed status

## *Sage Instruments 935AT Communications Test Set*

Output Pulse Level:	3.0 V. nominal base-to-peak into 100 Ohms resistive load
Output Imbalance:	Positive and Negative pulses are within 0.2 V. base-to-peak
Channel Selection:	Any one of 24 selectable from keypad
PCM Supervision Displays:	40 character vacuum fluorescent display shows A and B bit signaling states for all 24 channels (Option Menu #: 20) simultaneously. In ESF mode A, B, C and D bits are displayed. 4 LED's show status of on/off-hook supervision of selected time slot
Operating Modes:	TERMINATE: selected channel is connected to channel generator and receiver. Other 23 channels send IDLE code (7F) MONITOR: monitor selected channel in one or both directions. All 24 channels pass through unchanged. Framing is regenerated. DROP&INSERT: dual-direction only. Selected channel dropped out for testing. Other 23 channels pass through unchanged.
Pattern Simulation:	Idle Code (7F), Received PCM Optional patterns require Option 935AT-200, BERT Test Package.
Frame Loss Criteria:	Loss of frame occurs when 2 out of 4 Ft bits are in error for Superframe and SLC-96. Loss of frame for ESF occurs when 2 out of 4 FPS bits are in error
Error Displays:	Detects and counts Frame Errors, Bipolar Violations, Frame Slips and CRC Errors (ESF Only).
Alarms:	Sends Blue Alarm (All Ones) or Yellow Alarm (ALL Bit#2=0) on Superframe and sent on Facility data Link for ESF
Alarm Displays:	Detects and displays Frame Loss, Carrier Loss, Excess 0s, Yellow and Blue Alarm.

### PCM CHANNEL ENCODER

Analog Tone Generation:	20 Hz to 3904 Hz selectable in 1.0 Hz steps from keypad +3.0 dBm to -50.0 dBm in 0.1 dB steps selectable from keypad								
Frequency Response:	±0.1 dB (20 Hz to 3904 Hz)								
Basic Accuracy:	<table><thead><tr><th><u>Accuracy</u></th><th><u>Level</u></th></tr></thead><tbody><tr><td>±0.1 dB</td><td>+3.0 dBm0 to -30 dBm0</td></tr><tr><td>±0.2 dB</td><td>-30 dBm0 to -40 dBm0</td></tr><tr><td>±0.5 dB</td><td>-40 dBm0 to -50 dBm0</td></tr></tbody></table>	<u>Accuracy</u>	<u>Level</u>	±0.1 dB	+3.0 dBm0 to -30 dBm0	±0.2 dB	-30 dBm0 to -40 dBm0	±0.5 dB	-40 dBm0 to -50 dBm0
<u>Accuracy</u>	<u>Level</u>								
±0.1 dB	+3.0 dBm0 to -30 dBm0								
±0.2 dB	-30 dBm0 to -40 dBm0								
±0.5 dB	-40 dBm0 to -50 dBm0								
Supervision:	NORMAL (E&M), USER DEFINED states of A and B bits (C and D bits in ESF). FXO/FXS simulation (Option 935AT-25)								
Signaling:	MF, DTMF aDP								

### PCM CHANNEL DECODER

Recovered Analog Tones:	20 Hz to 3904 Hz ± 1 Hz								
Recovered Level:	+3.0 dBm to -40.0 dBm (Average and RMS)								
Basic Accuracy:	±0.1 dB with Digital Milliwatt								
	<table><thead><tr><th><u>Accuracy</u></th><th><u>Input Level</u></th></tr></thead><tbody><tr><td>±0.1 dB</td><td>+3.0 dBm0 to -30 dBm0</td></tr><tr><td>±0.2 dB</td><td>-30 dBm0 to -40 dBm0</td></tr><tr><td>±0.5 dB</td><td>-40 dBm0 to -50 dBm0</td></tr></tbody></table>	<u>Accuracy</u>	<u>Input Level</u>	±0.1 dB	+3.0 dBm0 to -30 dBm0	±0.2 dB	-30 dBm0 to -40 dBm0	±0.5 dB	-40 dBm0 to -50 dBm0
<u>Accuracy</u>	<u>Input Level</u>								
±0.1 dB	+3.0 dBm0 to -30 dBm0								
±0.2 dB	-30 dBm0 to -40 dBm0								
±0.5 dB	-40 dBm0 to -50 dBm0								

## Section VII Specifications

---

Frequency Response:  $\pm 0.1$  dB @ 204 Hz to 3904 Hz with 0 dBm applied.  
Supervision: On-hook and Off-hook supervision are user definable as any combination of A, C and B, D bits (i.e., 0, 1, or "don't care"). FXO/FXS supervision available with Option 935AT-25

Signal to Total Distortion:	<u>Input</u>	<u>7 5/6 Signaling</u>	<u>CCIS</u>
	0 to -30 dBm0	38 dB	40 dB
	30 to -40 dBm0	36 dB	36 dB
	-40 to -50 dBm0	32 dB	32 dB

Gain Tracking Error:	<u>Input</u>	<u>Max. Deviation</u>
	+3.0 to -30 dBm0	$\pm 0.1$ dB
	-30 to -40 dBm0	$\pm 0.2$ dB
	-40 to -50 dBm0	$\pm 0.5$ dB

Intrinsic Noise: 10 dBmC (with Idle Code received)

### 7-3 GENERAL

---

Impedances: 150, 600, 900, 1200 Ohms and > 50 KOhms Bridging  
Maximum DC Blocking: 160 VDC  
Audio Bandwidth:  $\pm 3.0$  dB 300 Hz to 3.0 kHz  
Audio Volume: Adjustable by front panel control

Longitudinal Balance: 90 dB at 60 Hz  
Receiver Return Loss: >30 dB 200 Hz to 5 kHz (600, 900, 1200 Ohms)  
>30 dB 800 Hz to 5 kHz (150 Ohms)

Display: 40 char. vacuum fluorescent plus 4 LED's for on/off-hook status  
AC Power Supply: 115 V AC  $\pm 10\%$ , 60 Hz  
Operating Temperature: 0° C to 50° C  
Storage Temperature: -40° C to 70° C  
Dimensions: 5.79" H. x 14.33" W. x 14.25" D  
Weight: 16 to 18 lbs. depending upon options

### 7-4 PURCHASE OPTIONS

---

#### 7-4.1 FAX/MODEM TIMS PACKAGE (Option 935AT-100)

---

##### PEAK-TO-AVERAGE RATIO (P/AR)

Transmit Level Range: 0 dBm to -40 dBm  
Resolution: 0.1 dB  
Receive Level Range: -40 dBm to +12 dBm  
Resolution: 0.1 dB  
P/AR Measurement Range: 0 to 120 P/AR units  
Resolution: 1 P/AR unit  
Accuracy:  $\pm 1$  P/AR unit



Phase/Amplitude Jitter and Hits

**PHASE AND AMPLITUDE JITTER MEASUREMENTS**

Received Holding Tone Level: +10 dBm to -40 dBm (Metallic)  
0.0 dBm to -40 dBm (PCM)  
Holding Tone Frequency Range: 990 Hz to 1030 Hz  
Phase Jitter Measurement: 0.0° to 30.0° peak-to-peak  
Accuracy: ±5%, ±0.2°  
Amplitude Jitter Measurement: 0.0% to 30.0% peak  
Accuracy: 4 Hz to 300 Hz, and 20 Hz to 300 Hz

**TRANSIENTS (HITS) MEASUREMENTS\***

Phase Hits: 5° to 50° peak in 10 steps  
Gain Hits: ±1 to ±10 dB in 1 dB steps  
Dropouts: Tone level drops below 12 dB ±1 dB  
Guard Interval: Per IEEE STD. 743-1984 Figs. 6 and 7  
Timer: Same as Impulse Noise  
Count Rate: Same as Impulse Noise  
Counter Capacity: Same as Impulse Noise

Envelope Delay Distortion

Modes: SEND and REPEAT (Master and Slave)  
Transmitter: 50% AM signal at modulation frequency of  $83\frac{1}{3}$  Hz  
Carrier Frequency: 304 Hz to 3504 Hz ± 2 Hz  
Carrier Level: 0.0 dBm to -40 dBm (Metallic), 0.0 dBm to -40 dBm (PCM)  
Flatness: ±0.2 dB (304 to 3504 Hz)  
Receiver Input Level: +10 dBm to -40 dBm (Metallic)  
0.0 dBm to -40 dBm (PCM)  
Distortion Measurement Range: +9000, -3000 μseconds  
Accuracy: ±10μs 604 Hz to 3504 Hz, ±30μs 304 Hz to 603 Hz

Intermodulation Distortion (Option 935AT-20)

Transmitter Spectrum: Four equal level tones (857, 863, 1372 and 1388 Hz)  
Harmonic Distortion: >35 dB below tone level  
Transmitter Level Range: 0 dBm to -40 dBm RMS (Metallic)  
-6 dBm to -40 dBm RMS (PCM)  
Accuracy: ±1 dB  
Receiver Input Level: 0 dBm to -40 dBm RMS (Metallic)  
-6 dBm to -40 dBm RMS (PCM)  
Distortion Products: 2nd Order centered at 520 and 2240 Hz  
3rd Order centered at 1900 Hz  
Distortion Range: 10 dB to 70 dB below signal-2nd Order  
10 dB to 70 dB below signal-3rd Order  
Resolution: 1 dB  
Accuracy: ±1 dB  
Signal-to-Noise Test: Removes Low Tone pair and increases level of remaining tone pair by 3 dB.

## Section VII Specifications

---

### Absolute Delay

Modes	Send and Repeat
Transmitter Frequency	50% AM signal with a Modulation Frequency of $83\frac{1}{2}$ Hz
Level	1020 Hz Send, 1800/1850 Hz Repeat
Flatness	0.0 dBm to -40.0 dBm
Delay Range	$\pm 0.2$ dB
Accuracy	0 to 1.2 sec
Harmonic Distortion	$\pm 0.1$ msec
	>35dB below tone level

### 3-Level Impulse Noise

Weighting Filter:	C-Notch
Threshold Range:	30 dBmC to 106 dBmC
Accuracy:	$\pm 1.0$ dB
Threshold Spread:	2, 4, 6, or 8 dB steps
Timer:	1 min. to 99 mins. or continuous
Counter Capacity:	0 to 9999 for LO, MD and HI.
Measurements Range:	7 to 99 measurements per second

### 23 Tones

#### **Transmitter**

Composite Level:	-40 dBm to -6 dBm
Individual Tones	
Level:	-13.6 dB below Composite Level
Flatness:	$\pm 0.1$ dB
Frequencies:	203.125 to 3640.625 Hz in 156.25 Hz steps $\pm 10$ ppm
Phase:	per IEEE 743 $\pm 0.25^\circ$
Peak to RMS Ratio:	8.79

#### **Receiver**

Range:	-40 dBm to -6 dBm
Level:	$\pm 0.2$ dB
Attenuation:	$\pm 0.2$ dB
Envelope Delay Distortion	
Accuracy:	$\pm 10$ secs
Range:	10,000 secs
Frequencies:	281.15 to 3562.5 Hz in 156.25 Hz steps
Signal-to-Noise:	$\pm 2$ dB from 10 dB to 24 dB $\pm 1$ dB from 25 dB to 40 dB $\pm 2$ dB from 41 dB to 45 dB
Signal-to-Total Distortion:	$\pm 2$ dB from 10 dB to 24 dB $\pm 1$ dB from 25 dB to 40 dB $\pm 2$ dB from 41 dB to 45 dB
Intermodulation Distortion : (2nd and 3rd order)	$\pm 2$ dB from 20 dB to 29 dB $\pm 1$ dB from 30 dB to 46 dB $\pm 2$ dB from 47 dB to 55 dB $\pm 3$ dB from 56 dB to 60 dB

7-4.2 DS-0/DS-1 Bit Error Rate Testing (Option 935AT-200)

DS-1 BERT Specifications

Framing:	Patterns may be framed (D4 or ESF) or unframed
Test Patterns:	Pseudo-random bit sequences (PRBS) of the following lengths may be sent and received: 29-1 (511) 211-1 (2047) 215-1 220-1 QRSS ( 220-1 with 14 zero suppression) 223-1
Stress Patterns:	3 in 24 bits (100010001000000000000000) 1 : 7 bits (10000000) 1 : 1 bits (1010) All 1s 55 OCTETS (440 bit pattern for Multiplexer Testing)
User-Defined Patterns:	User may input any bit sequence length from 1 to 24 bits (even numbers from 18 to 24). Pattern will continuously repeat
Loopback Codes:	Send and Receive CSU loop codes: Loop-Up=10000 continuous for 8 seconds Loop-Down= 100 continuous Other Loop codes can be sent and received by editing the above patterns up to 8 bits.
Error Injection:	Inject single logic errors, bipolar violations, frame errors (D4 mode) or CRC errors (ESF mode)
PRBS Receiver Sync:	128 consecutive error-free bits must be received to achieve synchronization. BER of greater than 10 <sup>-1</sup> for 320 milliseconds causes sync loss and resync attempt
Pattern Sync:	386 consecutive bits with less than 10 <sup>-2</sup> error rate must be received to achieve pattern sync. BER of greater than 10 <sup>-2</sup> for 2 milliseconds causes sync loss and resync attempt
Measurements:	Measures and displays: Bit (Logic) Errors, Bit Error Rate, Bit Slips, Bipolar Violations (BPV), Frame Errors, Frame Losses, Frame Slips, CRC Errors (ESF mode), Errored Seconds, % Errored Seconds, Error Free Seconds, % Error Free Seconds, Severely Errored Seconds, % Severely Errored Seconds, Failed Seconds, % Failed Seconds, Unavailable Seconds, % Unavailable Seconds, % Availability, No PCM, Test Length, Clock Time/Date, Elapsed Time.
Test Length:	Timed or continuous
Timed Test Length:	15 minutes, 1 hour or 24 Hours
56 kBps Mode:	Selected when 935AT is in Option 56. Least significant bit of channel under test is always set to 1. Selected when 935AT is in Option 56

## Section VII Specifications

---

	requires change to Clear Channel Signaling
Test Patterns:	Pseudo-random bit sequences (PRBS) of the following lengths may be sent and received: 29-1 (511) 211-1 (2047)
Stress Patterns:	1 : 7 bits (10000000) 1 : 1 bits (1010) All 1s
User-Defined Patterns:	User may input any bit sequence length from 1 to 8 bits. Pattern will continuously repeat.
Loop-Back Codes:	Send and Receive CSU/DSU/OCU loop codes in 56 kbps mode. LSB of selected channel byte is always set to 0. Cannot be used with switched 56 kbps channels using robbed bit signaling.
Error Counters:	All DS-1 errors (i.e., BPV errors, frame errors, CRC errors, Slips, etc.) are recorded for the entire DS-1. Bit Errors and Bit Error Rate are calculated on the received DS-0 channel selected. CCITT G.821 Error statistics are based on the bit errors of the selected DS-0 channel received.
Measurements:	Bit Errors, Bit Error Rate, No Sync, Error Free Seconds, % Error Free Seconds, Errored Seconds, % Errored Seconds, Severely Errored Seconds, % Severely Errored Seconds, Failed Seconds, % Failed Seconds, Available Seconds, % Available Seconds, Unavailable Seconds, % Unavailable Seconds and Elapsed Test Time
Error Injection:	Inject single bit errors